

TCSL DN65 - Flow limiter cartridge 35m³/h

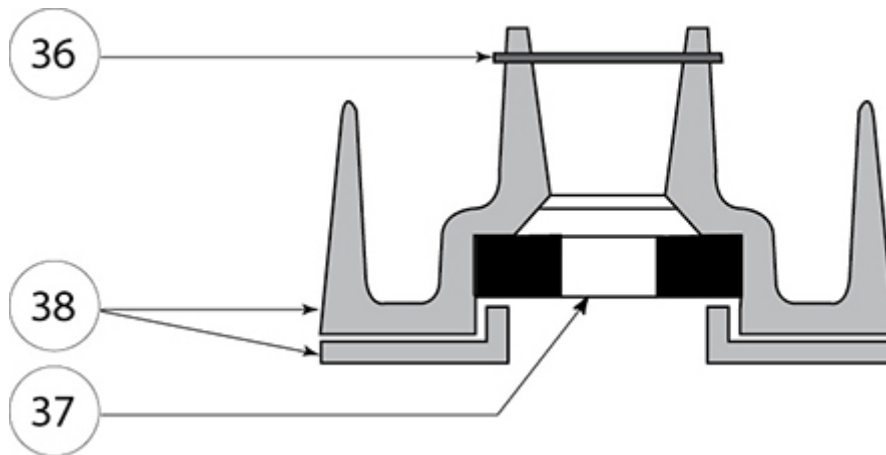

Net weight	References
0.40 kg	213540

This kit is composed of:

Item	Description	Number	Material
36	Grooved pin	1	-
37	Diaphragm 35 m ³ /h	1	-
38	Cartridge type D	1	-

The information on this sketch is, to the best of our knowledge correct at the time of printing. However Saint-Gobain are constantly looking at ways of improving their products and services therefore reserve the right to change without prior notice, any of the data shown. Any orders placed will be subject to our Standard Conditions of Sale, available on request.