



Access covers & gratings Ductile iron

03-2019

**INTERACTIVE
CATALOGUE**

Pass the trackball
on a product code
and you automatically
access to its data sheet!

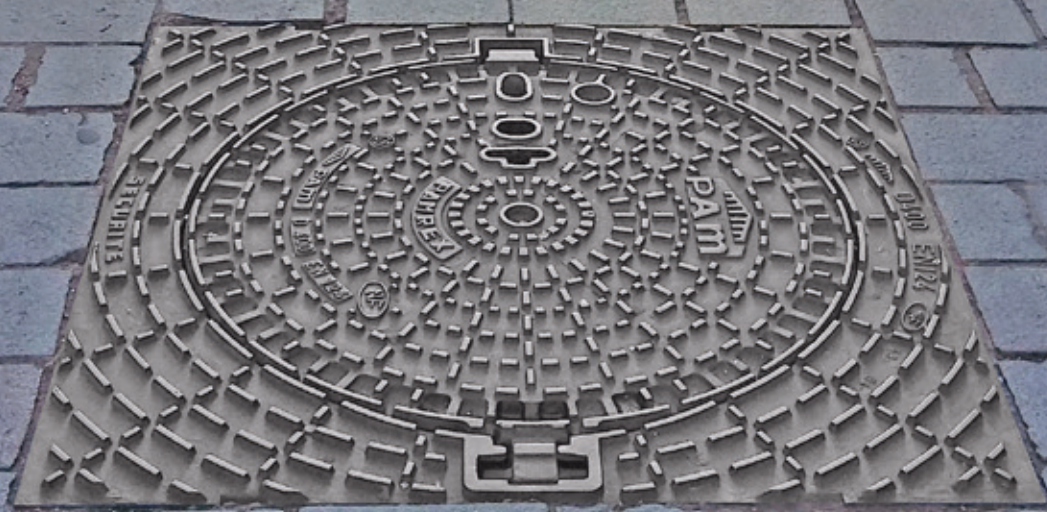

PIPELINE SOLUTIONS FOR THE FUTURE

PAM
SAINT-GOBAIN

MAKE YOUR CITIES MORE BEAUTIFUL

The digital & interactive badging & customisation solution for manhole covers!



My cover by PAM offers all clients the opportunity to customise* their covers by displaying on their top surface:

- a logo
- a text, e.g. field of application, owners' name, local authority's identity, etc.
- or both

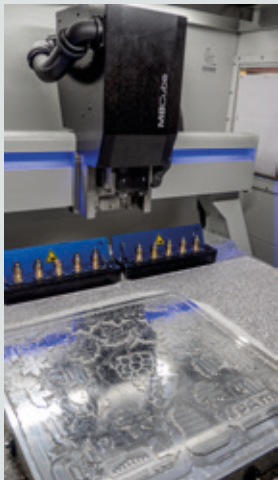

My cover by PAM website provides interactive and simple creation possibilities to draft the customisation of covers to be further produced by PAM

Once the draft of the customisation achieved by client and sent to Saint-Gobain PAM, a 3D-realistic final view of the customised cover will be sent by Saint-Gobain PAM in return to clients (picture 1), within a week, for approval, together with a quote.

Once approved & ordered, the customisation badging plates (pictures 2 3) will be produced by Saint-Gobain PAM and customised manhole covers will be further cast in Saint-Gobain PAM' foundry,

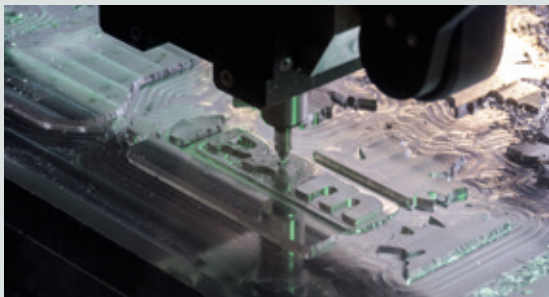

My cover by PAM will be available in 2019 on many countries, please consult your local Saint-Gobain PAM organisation for further information.

**Customisation of covers means cast badging during foundry process, and in no case affixing a badged plate on standard covers, by rivet, screws or adhesive, etc. Such practices being banned by EN 124.*

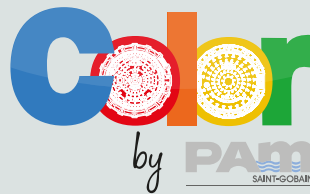

Embellish streets & places aesthetics with beautifully coloured covers & gratings.

The sustainable and aesthetic coating, is available on all Saint-Gobain PAM municipal casting products, developed to highlight historical cities centers and exceptional places.

1. Aesthetical

140-colors choice allows covers & gratings to fade away in the urban landscape or to bring nice colour touch.

2. Durability

Zinc-alu protection ensures heavy **anti-corrosion resistance** prior to coating. Tested at 280 bar, withstands high pressure jetting on public places, market places, etc.

3. Ergonomics

Color by PAM allows to avoid the use of heavy covers filled with pavement to match surroundings.



The carrousel testing rig, Saint-Gobain PAM private testing facility, the ideal environment to assess all our designs and productions in service conditions.



This testing facility enables to simulate in 3 months 20 years of intense traffic:

- Circumference: 90m
- Speed: up to 60 km/h
- 8-tonne axle load
- 6 rotations of the axle per minute
- Equivalent traffic of 6 trucks per day,

The aggressiveness of the test has been measured & validated in collaboration with road builders, during R&D partnerships.



A complete set of tests, measures & controls on all aspects of performance & durability:

- Resistance to ultra-heavy traffic stresses, durability
- Stability
- Quietness in use
- Efficiency & durability of gaskets
- Reliability & durability of spring bars lock & hinges
- Controls of bearing & bedding surfaces & mortars
- Anti-skid tests & measures
- Etc.

The Saint-Gobain PAM private flow capacity test bench, the ideal research and testing unit to measure and optimize absorption performances of gratings and gullies.



- Simulation of various rain intensities up to 180 m³/h
- Gratings, gullies prototypes & finished products installed in various kerb & channels configurations to assess their performances.

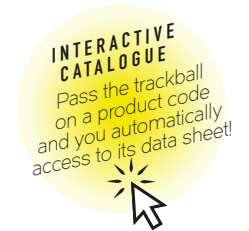

GENERAL CONTENTS

Value added proposals, customization service	page 0
Fields of expertise, quality & compliance	pages 1 - 3
Selection criteria for manhole covers	pages 4 - 5
Selection guide for manhole cover	pages 6 - 7
Manhole covers	pages 8 - 29
Installation guide for manhole covers and gratings	pages 30 - 31
Telecom covers and sealed covers	pages 32 - 35
Tree grates	pages 36 - 37
Selection criteria for gully grating	pages 38 - 40
Gully gratings	pages 41 - 59
Surface Boxes	pages 60 - 62

SUSTAINABLE DEVELOPMENT: SAINT-GOBAIN PAM COMMITS & COMPLIES!

Saint-Gobain PAM has achieved all complete life cycle analysis of their products.

The relevant environmental & Sanitary Declaration Forms (FDES) have been verified by third-parties bodies, on both Saint-Gobain PAM ① & Saint-Gobain PAM UK ② foundries.

①

②

QUALITY

STANDARD



European
Committee
for Standardization

EN 124: 2015 is the new version of the European Standard (EN) which governs design, features, & test methods of access covers & gratings.

This new standard is split in 6 parts, of which 2 address access covers & gratings in ductile iron:

- Part 1: Definitions, classification, general principles of design, performance requirements and test methods (this part relates to all materials).
- Part 2: Gully tops and manhole tops made of cast iron (this part is applicable to all PAM ductile access covers & gratings). These products will be marked **EN 124-2**.



CERTIFICATIONS OF COMPLIANCE

Third-party certifications cover a wide part of PAM access covers & gratings ranges.

The certification bodies have been chosen mainly according to market situations. They can alternatively be:



FRENCH CERTIFICATION MARK ISSUED BY AFNOR CERTIFICATION

<https://certification.afnor.org/qualite/nf-voirie>



GERMAN CERTIFICATION MARK ISSUED BY DIN CERTCO

https://www.dincertco.de/de/dincertco/produkte_leistungen/zertifizierung_produkte/bauwesen/schachtabdeckungen_aufsaeetze_kanalguss/schachtabdeckungen_aufsaeetze_kanalguss.html



AUSTRIAN CERTIFICATION MARK ISSUED BY MA 39

<https://www.wien.gv.at/forschung/laboratorien/vfa/zertifizierung/aufgaben.html>

PAM SELF DECLARATION OF COMPLIANCE

Occasionally, depending on various situations, PAM can issue such document, as permitted by the standard, The related **products** are **identified** in this catalogue with **EN 124 in red**, Documents available on request.



IMPORTANT REMINDER

**CE MARKING IS CURRENTLY NOT APPLICABLE FOR EN 124:2015 STANDARD.
THE USE OF CE MARKING ON DOCUMENTS & PRODUCTS IS FORBIDDEN.**

SELECTION CRITERIA FOR MANHOLE

PLACES OF INSTALLATION

Standard EN 124 divides products into minimum level groups and classes according to their intended place of installation :

Some manhole covers are capable of passing a test load which exceeds that specified for their class. Others are fitted with a reinforced frame in order to ensure stability in especially severe traffic conditions, while remaining in compliance with the installation conditions considered in the standard.

Group 6	CLASS F900	Areas imposing particularly high wheel loads, such as aircraft pavements, etc..
Group 5	CLASS E600 mini	Areas imposing high wheel loads, such as docks, port areas, aircraft pavements, airports, factory yards, etc..
Group 4	CLASS D400 mini	Carriageways of roads - including pedestrian streets, hard shoulders and parking areas for all types of road vehicles.
Group 3	CLASS C250 mini	For gully tops installed in the area of kerbside channels of roads which, when measured from the kerb edge, extend to a maximum of 0.50 m into the carriageway and a maximum of 0.20 m into the footway.
Group 2	CLASS B125 mini	Footways, pedestrian areas and comparable areas, car parks and car parking decks.

TRAFFIC STRESSES

In addition to the group and class concepts specified in EN 124, it is recommended that specific traffic and operating stresses should also be taken into account in order to select the most suitable product.

The following three parameters:

- number of vehicles,
- speed,
- type of vehicles (cars or heavy vehicles using the carriageway, are combined and contribute to the definition of the concept of the type of traffic).

TYPE OF TRAFFIC	NUMBER OF VEHICLES	SPEED	TYPE OF VEHICLES
• Intense	• High	• Speed authorized on large urban roads	• Regular use by heavy vehicles
• Normal	• Irregular	• Stabilized urban speed	• Essentially light vehicles • Transit of heavy vehicles
• Low	• Low	• Limited speed	• Occasional truck traffic (deliveries, etc.)

Saint-Gobain PAM designs their manhole covers in accordance with traffic stresses in terms of stability, safety and silence.

The type of technical solutions implemented depends on the intended use of the casting.

TYPE OF TRAFFIC	SECURING OF COVER GRATING IN FRAME	STABILITY BEARING	DEPTH OF INSERTION	FRAME DEPTH
• Intense	• Weight of cover	• Elastomer ring	• $l \geq 80$ mm	• F = 100 mm
• Normal	• Locking • Metal seating	• Composite ring	• Locking or $l \geq 50$ mm	• F = 100 mm or F = 75 mm with anchoring means

NOTE: Standard EN 124 specifies that, where there is any doubt on the class to be used, the higher class must be selected.

COVERS

OPERATING STRESSES

Efficient management of sewer systems requires more frequent inspections and checks. The handling of municipal castings designed without due care can lead to damage in the lumbar region of the back and spine.

All PAM manhole covers are designed to facilitate opening and closing operations with a minimum of force and to provide service teams with more ergonomic working conditions.

RANGE MAPPING

Saint-Gobain PAM offers a very wide range of carriageway manhole covers in accordance with all the requirements of standards and satisfying the specific criteria of each place of installation.

Occasional inspections | Periodic inspections | Frequent inspections

Opening assistance system		
<ul style="list-style-type: none"> None 	<ul style="list-style-type: none"> Hinged mechanism Pins 	<ul style="list-style-type: none"> Hinge
User safety		
<ul style="list-style-type: none"> Cover positioning marker 	<ul style="list-style-type: none"> Device ensuring holding of tool and guidance of cover 	<ul style="list-style-type: none"> 90° locking Opening to 130°
Opening ergonomics		
<ul style="list-style-type: none"> Bending of back and pulling Lifting effort 	<ul style="list-style-type: none"> Handling in two steps 	<ul style="list-style-type: none"> 1 single movement Standing position

CLASS F900	Specific areas (airports, docks, plants yards, etc)	PAMREX 900 / URBAMAX 900		
CLASS E600		PAMREX 600 / URBAMAX 600		
CLASS D400	Intense traffic	AMBER	KORUM	PAMREX VIATOP
	Normal traffic	PAMTIGHT QUAD REXESS 2		-
	Low traffic	G-TEX	PLANET ASTRA	-
CLASS C250	Car parks Kerbsides Pedestrian streets	PAYSAGE 2 / PARXESS		
CLASS B125	Pavements and pedestrian streets	AKSESS / PASSUS / PAVEMENT / TEK		

TRAFFIC STRESSES

Occasional inspections | Periodic inspections | Frequent inspections

OPERATING STRESSES

TECHNICAL CHARACTERISTICS OF MANHOLE

STRENGTH CLASS	TYPE OF MANHOLE COVER	pages	FRAME		COVER		STRENGTH	
			shape	dimensions	clear opening	type of traffic	breaking margin	resistance compound
CLASS F900	URBAMAX® F900	9	circular & square	850	600	INTENSE	○○	++++
	PAMREX® F900	11	circular & square	850	600	INTENSE	○○	++++
CLASS E600	URBAMAX® E600	9	circular & square	850	600	INTENSE	○○	++++
	PAMREX® E600	11	circular & square	850	600	INTENSE	○○	++++
CLASS D400	PAMREX® 600	10	circular & square	850 / 840	610	INTENSE	○○○	++++
	PAMREX® apparent frame	10	square	850	610	INTENSE	○○○	++++
	PAMREX® 700	11	circular & square	900 / 950	700	INTENSE	○○○	++++
	PAMREX® 800	11	circular & square	1000 / 1000	800	INTENSE	○○○	++++
	VIATOP NIVEAU	14	circular	1135 / 1138	610	INTENSE	○○○	++++
	KORUM®	18	circular & square	811 / 811	606	INTENSE	○○	+++
	REXESS2®	20	circular	842	600	MEDIUM	○○	++
	PLANET	21	circular	785	600	LOW	○○	++
	ASTRA	21	circular	725 / 685	600	LOW	○○	+
	G-TEX®	22	circular & square	850 / 830	600	LOW	○○	++
	QUAD	22	square	550 / 650 / 750	400 / 500 / 600	LOW	○○	++
	PAMTIGHT 600	15	circular	850	600	MEDIUM	○○	++
	PAMTIGHT 800	15	circular	989	800	MEDIUM	○○	++
CLASS C250	PAYSAGE 2	24	circular & square	850 / 850	600	LOW	○	+++
	PARCESS®	23	square	450 à 730	303 à 600	MEDIUM	○○○	++++
	HEIGHT ADJUSTABLE inspection covers	25	circular & square	360 / 318	225 / 180	LOW	○	+++
CLASS B125	PASSUS®	29	circular	782 / 720	600	LOW	○○	+
	AKSESS®	26	square	310 à 820	220 à 700	LOW	○○○	++
	TEK	29	circular	785	600	LOW	○○	++

STABILITY AND OPERATING FACTORS, RESISTANCE COMPOUND=

- Multiple-criteria comparison between products within the same class only (Class D 400, for example).
- Resistance compound aggregates various frame and cover design features

NOTE • Strength margins are specified with regard to the classes of utilization to which the respective products correspond.
 • The field of application of products is limited to their utilization class by design

COVERS

STABILITY				OPERATING-FACTORS	
frame depth	frame/cover seating/material	depth of insertion	stability factor	special device	operating factor
100	elastomer	85	++++	no hinge	++
100	elastomer	85	++++	ball joint hinge	++++
100	elastomer	85	++++	no hinge	++
100	elastomer	85	++++	ball joint hinge	++++
100	elastomer	85	++++	ball joint hinge	++++
160	elastomer	85	++++	ball joint hinge	++++
100	elastomer	85	++++	ball joint hinge	++++
125	elastomer	76	++++	double ball joint hinge	+++
140 / 200	elastomer	72	++++	ball joint hinge	++++
100	composite	locked	+++	ball joint hinge	++++
100	composite	locked	+++	hinge + spring bar	+++
100	PE	locked	+++	hinge + spring bar	+++
100	PE	locked	+++	hinge + spring bar	++
100	PE	locked	++	spring bar	++
100	dynamic metallic contact	locked	++	hinge + spring bar	+++
100	elastomer + PE	bolted	+++	6 bolted clamps	+
100	elastomer + PE	bolted	+++	8 bolted clamps	+
75	composite	not applicable (EN 124)	+++	hinge + spring bar	+++
56	dynamic metallic contact	not applicable (EN 124)	++++	2 opening modes	++++
180 / 154	metallic	not applicable (EN 124)	+++	for PPIC Ø 250, 300 et 400	++++
70	PE	locked	+++	hinge + spring bar	++++
37 to 41	dynamic metallic contact	not applicable (EN 124)	++++	2 operating modes	++++
100	PE	locked	+++		++++

BREAKING STRENGTH MARGIN =

Comparison between average breaking strength of the product and the EN 124 requirement.

- = average breaking strength up to 20% higher than EN 124 requirement.
- = average breaking strength up to between 20% and 30% higher than EN 124 requirement.
- = average breaking strength more than 30% higher than EN 124 requirement.

MANHOLE COVERS

Technical characteristics of manhole covers page 6

URBAMAX page 9

PAMREX pages 10/11

Accessories for all PAMREX manholes and gratings range pages 12/13

VIATOP NIVEAU | VIATOP STANDARD page 14

PAMTIGHT page 15

Double triangular covers | **OPT-EMAX | INTER-AX2 | ULT-EMAX** pages 16/17

KORUM pages 18/19

REXESS 2 page 20

PLANET | ASTRA page 21

G-TEX | QUAD page 22

PARXESS | PARXESS AR page 23

PAYSAGE 2 | TERRITORIALES by PAM page 24

Manhole covers for parking areas page 25

AKSESS | AKSESSAR pages 26/27

Other B125 Manhole covers page 28

TEK | PASSUS | OPTEA page 29





F900 **E600**



URBAMAX®

URBAMAX

- Ductile iron
- Elastomer ring
- Push-in central pad
- Sealed handling box
- EN 124  

STRENGTH

URBAMAX, class E 600 and F 900, has a high tensile strength.

STABILITY

The weight of the cover (63 kg in the non-ventilated version) and the addition of an elastomer ring and a double skirt dampens vibrations caused by traffic, ensuring total stability.

OPERATION

A handling box allows URBAMAX to be handled with traditional site tools : such as a pointed or flat end pick-axe, or crowbar. The cover is specially designed to ease closing.

Designed to withstand all types of traffic, URBAMAX can be installed on roads subjected to super heavy duty loading in addition to airports and dock areas, etc..

TYPE	FRAME	MASS		DIMENSIONS		REFERENCE
		total	cover	clear opening	frame depth	
F 900 Non-ventilated	circular	89	59	600	100	CFUR60AF
	square	100	59	600	100	CFUR60KF
F 900 Ventilated	circular	89	59	600	100	CFUR60BF
	square	100	59	600	100	CFUR60LF

INTERACTIVE CATALOGUE
Pass the trackball on a product code and you automatically access to its data sheet!



URBAMAX F 900



TYPE	FRAME	MASS		DIMENSIONS		REFERENCE
		total	cover	clear opening	frame depth	
E 600 Non-ventilated	circular	89	59	600	100	CEUR60AF
	square	100	59	600	100	CEUR60KF
E 600 Ventilated	circular	89	59	600	100	CEUR60BF
	square	100	59	600	100	CEUR60LF

URBAMAX E 600

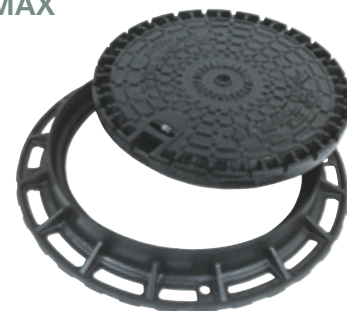



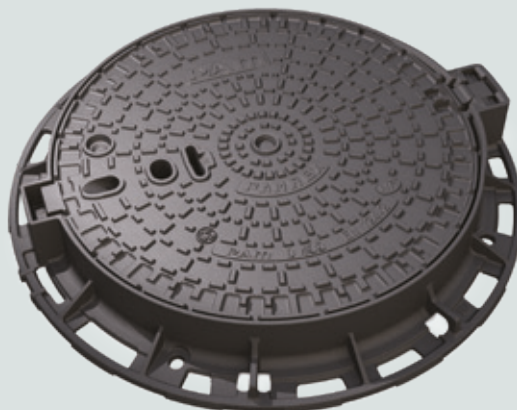

PAMREX®



D400

- Ductile iron
- Hinged
- Elastomer ring
- Sealed handling box
- Optional anti-theft cover lock
- Lifting rings int
- EN 124  

THE PAMREX® RANGE

PAMREX 600 only is available as «Territoriales by Pam» option
For more information, see page 24



**PAMREX® 600
SAFETY
D400**

TYPE	FRAME	MASS		DIMENSIONS		REFERENCE
		total	cover	clear opening	frame depth	
non-ventilated	round	84	53	610	100	CDPA60EF
	square	95	53	610	100	CDPA60MF
ventilated	round	84	53	610	100	CDPA60FF
	square	95	53	610	100	CDPA60PF

- Opens to 130°
 - Blocks at 90° when closing
- for sewage pipeworks



**PAMREX® 600
OPERATION
D400**

TYPE	FRAME	MASS		DIMENSIONS		REFERENCE
		total	cover	clear opening	frame depth	
non-ventilated	round	85	53	610	100	CDPA60AF
	square	95	53	610	100	CDPA60KF
ventilated	round	85	53	610	100	CDPA60BF
	square	95	53	610	100	CDPA60LF

- Opens to 130°, without blocking at 90° when closing
- for pipeworks inspection from road surface

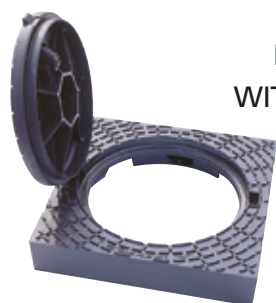

**PAMREX® 600
WITH APPARENT
FRAME
D400**

TYPE	FRAME	MASS		DIMENSIONS		REFERENCE
		total	cover	clear opening	frame depth	
non-ventilated	apparent	156	55	610	160	CDPA603F
ventilated	apparent	139	53	610	160	CDPA604F

- Frame designed for easy cobbles and paving installation
 - Height= 160 mm
- for paved and pedestrian streets

The PAMREX grating is interchangeable with any cover of PAMREX 600 series
The PAMREX grating is interchangeable with the cover
Special versions of PAMREX fitted with a water-tightness plug are also available. Please consult us.

TYPE	FRAME	MASS		DIMENSIONS		REFERENCE
		total	cover	clear opening	frame depth	
non-ventilated	round	108	71	700	100	CDPA70EF
	square	118	71	700	100	CDPA70MF
ventilated	round	108	71	700	100	CDPA70FF
	square	118	71	700	100	CDPA70PF

PAMREX® 700 has the same functional features as PAMREX® 600 (see page 8). Access is made through a wide 700mm opening specifically designed for systems requiring special safety conditions for operators.

PAMREX® 700 SAFETY D400



TYPE	FRAME	MASS		DIMENSIONS		REFERENCE
		total	cover	clear opening	frame depth	
non-ventilated	round	117	73	800	125	CDPA80EF
	square	127	73	800	125	CDPA80MF
ventilated	round	117	73	800	125	CDPA80FF
	square	127	73	800	125	CDPA80PF

PAMREX® 800 provides easy opening, while continuing to offer the high performance levels of the successful Pamrex 600 mm and 700 mm clear opening designs. The 800 mm clear opening enables maintenance personnel to enter the manhole with their safety equipment, or to lower bulky equipment into the below ground network

PAMREX® 800 SAFETY D400



TYPE	FRAME	MASS		DIMENSIONS		REFERENCE
		total	cover	clear opening	frame depth	
non-ventilated	round	120	73	800	125	CDPA80EFX37
	square	130	73	800	125	CDPA80MFX37
ventilated	round	120	73	800	125	CDPA80FFX37
	square	130	73	800	125	CDPA80PFX37

This version has the same features as the PAMREX® 800 standard version. The lifting effort and the stresses transmitted to the chamber are reduced with its assistance stainless steel gas arm. This product is systematically fitted with a SCS locking system.

PAMREX® 800 SAFETY D400 opening assisted by gas jack

Closing with SCS locking kit
(key not-provided)



E600

TYPE	FRAME	MASS		DIMENSIONS		REFERENCE
		total	cover	clear opening	frame depth	
ventilated	round	90	59	610	100	CEPA60EF

PAMREX® E 600 SAFETY E 600

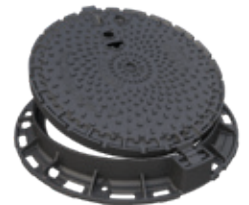

F900

TYPE	FRAME	MASS		DIMENSIONS		REFERENCE
		total	cover	clear opening	frame depth	
ventilated	round	90	59	610	100	CFPA60EF

PAMREX® F 900 SAFETY F 900

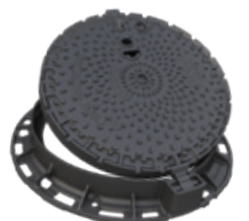

1/4 turn lock actuated by an asymmetrical five-sided bolt head (PENTA) or unique notched cylindrical head (SCS).

On site installation takes 5 minutes:

- Punch out the centre of the locking bolt area.
- Install the kit in compliance with the instructions supplied.

Lock must be operated with the handling key supplied separately.

LOCKING KITS



→ Locking clip, PENTA or SCS bolt

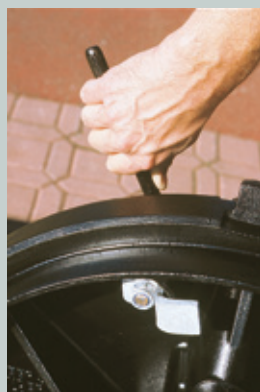

→ 1/4 turn lock system



→ PENTA plus ductile locking clip

KITS PENTA

for PAMREX 600, 700 & 800

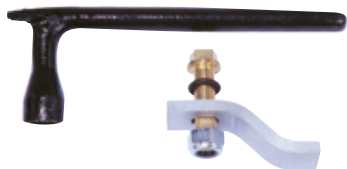

→ PENTA bolt and key

It is recommended not to use the SCS key to open the cover.

DN	MODEL	REFERENCE
PENTA - locking clip in stainless steel		
600	kit without locking key Penta	C6
700		
800	kit without locking key Penta	C14
PENTA Plus - locking clip in ductile iron		
600	kit without locking key Penta	C56
700		
800	kit without locking key Penta	C76
-	locking key Penta	C17

KITS SCS

for PAMREX 600, 700 & 800



→ SCS bolt and key

DN	MODEL	REFERENCE
SCS - locking clip in stainless steel		
600	kit without locking key SCS	C8
700		
800	kit without locking key SCS	C16
SCS Plus - locking clip in ductile iron		
600	kit without locking key SCS	C58
700		
800	kit without locking key SCS	C78
-	locking key SCS	C18

HOLES AND GRATINGS

Designed for ventilated covers and grating

Four suspension legs rest on elastomer ring

High resistance to load of sand and mud

Mudpans do not impair manhole covers or gratings normal functioning

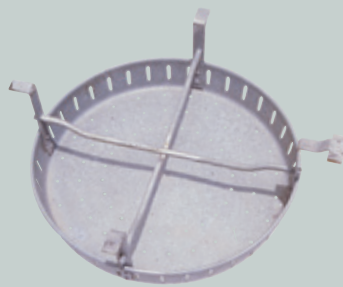

MODEL	REFERENCE
steel mudpan	for PAMREX 600 C1
	for PAMREX 700 C2
	for PAMREX 800 C3

GALVANISED STEEL MUDPAN
for PAMREX



TYPE	DIMENSIONS					MASS	REFERENCE
	Ø D	C	B	I	A		
1 BS1247 galvanised	-	153	365	60	153	2	C25
2 standard	25	300	200	60	350	2.4	C26
3 with handbar cross	25	300	200	60	350	2.5	C27
4 with handbar holder	25	300	200	60	350	2.5	C28
5 handbar	25	-	-	-	1200	5.3	C29

□ complies with EN 124 functional requirements

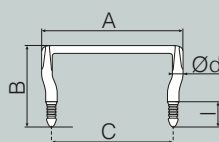

INSPECTION MANHOLE STEPS
DUCTILE IRON



MAINTENANCE RING	TYPE OF JOINT	REFERENCE
600	elastomer	CDPA60EF-L
700	elastomer	CDPA70EF-L
800	elastomer	CDPA80EF-L

PAMREX® RUN OFF WATER SEAL	REFERENCE
600	tightness joint C45

TIGHTNESS RUN OFF PAMREX® CAP	REFERENCE
600-700	tightness plug 170902
800	tightness plug 178808

The seal association with the PAMREX cap reduces the entry of runoff water to 0.5 l/min under a 3 cm water layer.



VIATOP

VIATOP

D400

V IATOP NIVEAU
 Ductile iron manhole cover
 Hinged with 90° blocking
 Interchangeable cover
 with Viatop
 Clear opening: 610 mm
 or 700 mm
 Height adjustable
 Elastomer ring
 EN 124  



→ VIATOP NIVEAU 140



VIATOP NIVEAU D400

→ VIATOP NIVEAU 200



CONCRETE ADAPTATION RINGS

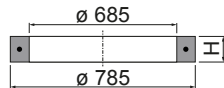

TYPE	FRAME	MASS		DIMENSIONS			CONCRETE INFILLED COVER	REFERENCE
		total	cover	clear opening	frame overall	frame depth		
VIATOP NIVEAU 600 H 200								
ventilated	round	128	49	610	815	200	-	CDVM60RG
non-ventilated	round	129	51	610	815	200	-	CDVM60QG
VIATOP NIVEAU 600 H 140								
ventilated	round	108	49	610	815	140	-	CDVM60RGX40
non-ventilated	round	109	51	610	815	140	-	CDVM60QGX40
VIATOP NIVEAU 700 H 200								
ventilated	round	118	71	700	932	217	-	CDVT70RU
non-ventilated	round	118	71	700	932	217	-	CDVT70QU



MODEL	MASS	DIMENSIONS	REFERENCE
To be used with Viatop Niveau frames. Compliant with DIN 4034-1. 2 heights available.			
For NIVEAU 200	25	H = 100	C23
For NIVEAU 140	17	H = 60	123 581

VIATOP STANDARD D400



D400

V IATOP STANDARD
 Ductile iron manhole cover
 Hinged cover
 Interchangeable cover
 with Viatop Niveau

Ergonomic handling
 Height adjustable
 Elastomer ring
 EN 124  

TYPE	FRAME	MASS		DIMENSIONS			CONCRETE INFILLED COVER	REFERENCE
		total	cover	clear opening	frame overall	frame depth		
ventilated	round	85.0	49.0	610	785	110	-	CDVM60BG
non-ventilated	round	58.0	49.0	610	785	110	-	CDVM60AG

GALVANISED STEEL MUDPAN



DESCRIPTION	MODEL	REFERENCE
steel mudpan	for VIATOP NIVEAU 600	C4
	for VIATOP NIVEAU 700	C2

D400

PAMTIGHT 600

Ductile iron manhole cover

PAMTIGHT manhole covers are water resistant (backflow) up to 1 bar of water pressure, Also prevents ingress of surface water.

2 rings: polyethylene seating ring or elastomer sealing ring

Fastened by 6 bolts and clamping claws

Sealed handling box

EN 124 

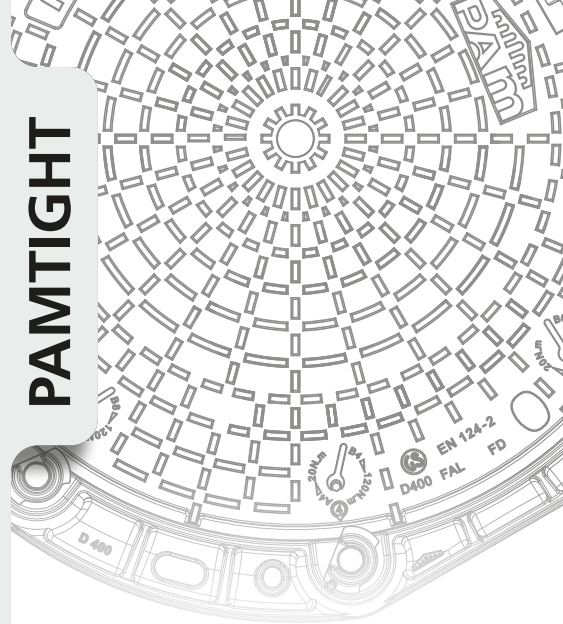

PAMTIGHT

**PAMTIGHT 600
D400**



TYPE	FRAME	MASS		DIMENSIONS			REFERENCE
		total	cover	clear opening	frame overall	frame depth	
non-ventilated	round	95.0	48.8	610	850	100	CDPE60AA

D400

PAMTIGHT 800

Ductile iron manhole cover

2 joints: E Sound proof joint or Elastomer Tightness joint

Fastened by 8 bolts and clamping claws

Occasional inspection

EN 124 

TYPE	FRAME	MASS		DIMENSIONS			REFERENCE
		total	cover	clear opening	frame overall	frame depth	
non-ventilated	round	129.5	66.5	820	1060	100	CDPE80AZ

- Hard shoulders and parking areas for all types of road vehicles

**PAMTIGHT 800
D400**

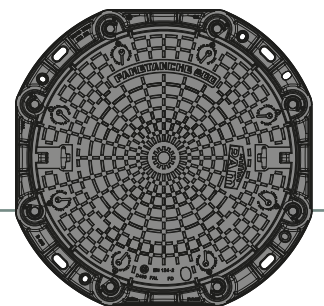

OPT-EMAX

D400

OPT-EMAX

Ductile iron

Hinged access cover range

Master and Slave Cover System

Retro fit Locking Option

LTS Feature

EN 124 

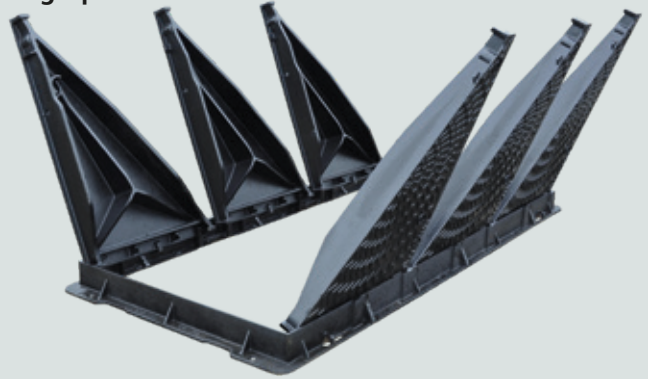

OPT-EMAX
D400

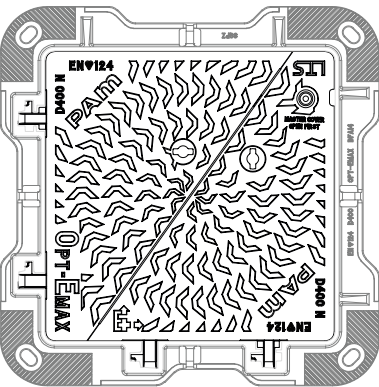

RECOMMENDED FOR USE IN: City roads carrying continuous traffic where frequent access to below ground assets is required. Available in a wide range of clear openings and in 100 mm or 150 mm frame depths, OPT-EMAX is the ergonomic solution for the frequent maintenance and inspection of below ground assets.

MASS		COVERS	DIMENSIONS			REFERENCES
total	cover	number	overbase C x D	clear opening A x B	frame depth	
77	22	2	800 x 850	600 x 450	100	185719
91	27	2	800 x 800	600 x 600	100	172472
117	38	2	875 x 875	675 x 675	100	CDOP67MK
121	41	2	940 x 745	750 x 600	100	186787
124	38.5	2	950 x 825	750 x 700	100	242791
129	43	2	905 x 940	750 x 750	100	186785
128	23 & 36 ⁽⁴⁾	3	1100 x 800	900 x 600	100	185735
211	68	2	1163 x 1155	910 x 900	125	228735 ⁽³⁾
175	38.5 & 43 ⁽⁴⁾	3	1210 x 850	1060 x 700	100	186789 ⁽¹⁾
218	39	4	1380 x 885	1220 x 685	100	185744
221	41	4	1350 x 945	1200 x 750	100	205457
278	55	4	1500 x 1060	1340 x 900	100	230384 ⁽²⁾
239	43	4	1660 x 940	1500 x 750	100	CDOP19GK
325	41	6	1995 x 940	1800 x 750	100	186795
407	55	6	2170 x 1060	2010 x 900	100	230385 ⁽²⁾
349	43	6	2420 x 940	2250 x 750	100	230108

⁽¹⁾ MK 1 Type hinge (Not Tilt & Push)

⁽²⁾ Tilt & Push In-Board hinge type

⁽³⁾ This unit requires on Lock in each Corner

⁽⁴⁾ Covers are triangular and by design are of different sizes

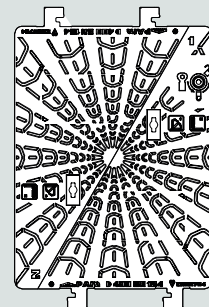
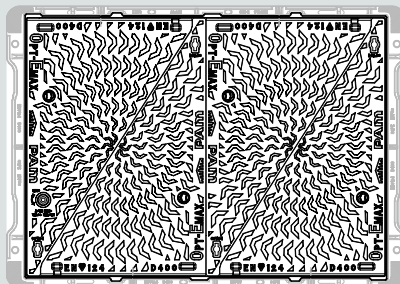



INTER-AX2

- Ductile iron
- Double Triangular Access Cover
- Off centre split
- Notched frame
- LTS Feature
- EN 124

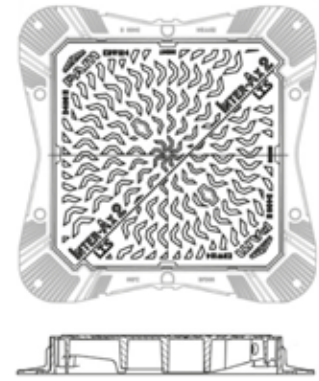

RECOMMENDED Inter Ax, features 2 double tri fastened covers and
FOR USE IN : can be operated by 2 men using lifting keys, to offer a man-entry aperture

MASS		DIMENSIONS			REFERENCE
total	cover	overbase	clear opening	frame depth	
74.4	44.1	800x800	600x600	100	185892
83.5	44.1	800x800	600x600	150	185904
92.0	59.1	878x828	675x675	100	211603
102.9	59.1	878x828	675x675	150	211604

INTER-AX2 D400



ULT-EMAX

- Ductile iron
- Semi-Hinged and Locked Access Cover
- Spring Bar Locking Device
- Ergonomically Positive Hinge
- LTS Feature
- EN 124

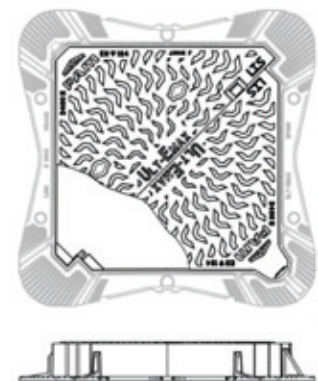

RECOMMENDED ULT-EMAX is the ideally installed on chambers which
FOR USE IN : mainly require inspection from surface, Its smallest cover, spring-bar locked can be first opened to provide visual access to chamber, Where necessary, the 2 covers can be removed by 1 man only to offer a man-entry aperture.

MASS		DIMENSIONS			PACK.	REFERENCE
total	cover	overbase	clear opening	frame depth		
84.0	27.3 / 20.7	806x806	600x600	100	10	205763
94.0	27.3 / 20.7	806x806	600x600	100	10	205765
97.0	35.5 / 26.2	880x830	675x675	100	10	211605
107.5	35.5 / 26.2	880x830	675x675	150	5	211606

ULT-EMAX D400



Opt-Emax, Inter Ax, & Ult-Emax frames can be fitted with **INSTALL PLUS**, levelling inserts which facilitates frame levelling & bedding, when using flowable bedding mortar.

Set of 4x **INSTALL PLUS** levelling inserts for the bedding of one Recess 2 frame

C103





KORUM

Korum



D400

KORUM

Ductile iron

Hinged

Composite ring

Sealed handling box

Spring bar

Optional anti-theft spline

Optional anti-intrusion lock

EN 124  

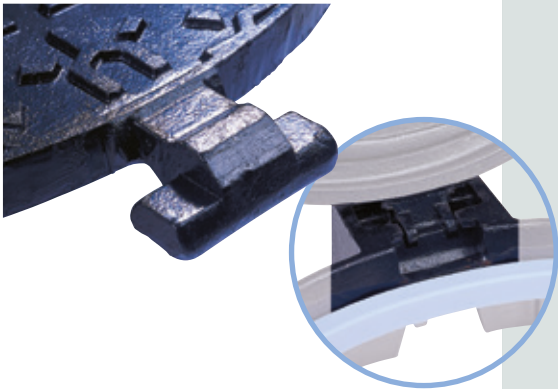

OPERATING SAFETY

ERGONOMICS

KORUM has been designed for operators who want to provide maintenance agents with safe and easy operating conditions. KORUM's design limits efforts to be made during visual inspections and sanitation visits.

→ Practical and safe manoeuvres thanks to the kneecap

- Easy manoeuvres: reduction of slack and interstices prevention of manhole cover clogging.
- Accurate and safe guiding of the cover by the ball joint, at the opening and the closing.
- Prevention of jamming risks.
- The durability of KORUM is ensured for a very long period of service: lack of contact between the frame and the ball of KORUM once locked.

→ Cover security lock open 90°

- Prevention of any sudden and accidental closure during handling and visits.

→ Lifting rings integrated into the frame

- Facilitate the transport of KORUM and its installation on the chimney, in complete safety.

→ Automatic locking without accessories

- Without key or screw, the KORUM cover is automatically locked when closed
- No adjustment or maintenance of the elastic bar, which remains safe and effective, after many cycles of unlocking / locking

→ Unlocking and opening the cover effortlessly

- Unlocking the cover with the peak of the pickaxe
- Reduce effort during handling : opening with pickaxe
- Significantly reduced physiological constraints : no need to bend over to manoeuvre



SECURITY OF THE PUBLIC

HIGH-LEVEL ROBUSTNESS

KORUM is a very robust cover, designed and manufactured to cope with the repeated loads of high traffic. Numerous laboratory and road site tests carried out over a period of several months under demanding traffic conditions have validated a design combining safety of use and longevity. KORUM is built to sustainably resist the flow of cars and trucks in urbanized areas and on major highways. KORUM has an average breaking strength of more than 25% compared to the requirement of EN124, Class D400.

DESIGN INTELLIGENCE

In case of network overloads, the KORUM cover opens up while remaining attached to the frame. Guided precisely by its ball joint, it closes naturally under the effect of its own weight, and re-locks, thanks to the elastic bar, the passage of the first vehicle.

→ Ergonomics

- Safe and effortless handling thanks to the ball-joint hinge.
- Effortless unlocking and opening of cover with pickaxe point

→ Operation

- The hinge blocks at 90° when closing and ensures operating safety

→ Strength

- New frame and ribs design prevent the deformation of the KORUM under intense traffic conditions

→ Stability

- The spring locking mechanism under constant tension locks the KORUM cover in place in its frame in complete safety.

TYPE	FRAME	MASS		DIMENSIONS		REFERENCE
		total	cover	clear opening	frame depth	
non-ventilated	round	62	38	606	104	CDKO60EF
	square	70	38	606	104	CDKO60MF
ventilated	round	62	38	606	104	CDKO60FF
	square	70	38	606	104	CDKO60PF
New KORUM H75						
non-ventilated	round	59.6	38.0	602	75	CDKO60EZX51

DESCRIPTION	REFERENCE
Anti-intrusion kit	
kit without handling key	C47
handling key	C46
□ The D50 locks have a cast iron bar for high resistance to vandalism attempts.	
Anti-theft key kit	
anti-theft spline	170900
kit of 10 splines	C59
□ Made of ductile iron, it can be added on site in the joint to prevent the removal of the cover from its frame.	
Maintenance ring	
joint EVA (vinyl acetate)	CDKO60BF-J



→ Pressure test



KORUM D400

INTERACTIVE CATALOGUE
Pass the trackball on a product code and you automatically access to its data sheet!



KORUM ACCESSORIES

ACCESSORIES

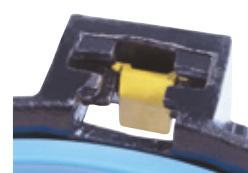



REXESS 2

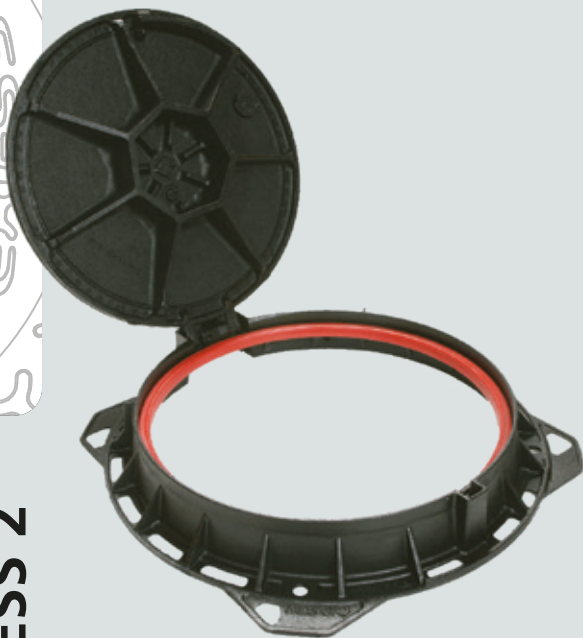

D400

REXESS-2

Ductile iron

Automatic locking by ductile iron spring bar

Hinged cover with 90° safety blocking

Optional anti-theft spline and locking system

Composite seating ring

EN 124 ÜA

Compatible with **INSTALL PLUS**



Ergonomy

A new way to open covers, taking a greater care of physical stress and pain.



NEW ANTI-THEFT SPLINE

C104



Customization

A fully customizable area to better and wider promote your identity.

Installation

An innovative bedding technique, more reliable and less time demanding.

Durability

An heavy-duty joint material providing extended durability.

**REXESS-2
D400**



DIMENSIONS					MASS		REFERENCE
A	C	O	H	E	total	cover	
785	645	608	104	92	55.0	33.5	CDRL60FYX44
785	645	608	104	92	56.3	31.5	CDRL60EYX44



install plus

Rexess 2 frame is compatible with **INSTALL PLUS**, levelling inserts which facilitates frame levelling & bedding, when using flowable bedding mortar.

Set of 4x **INSTALL PLUS** levelling inserts for the bedding of one Rexess 2 frame

C103



D400

PLANET

- Ductile iron
- Round frame
- Non Ventilated
- Water base coating
- PE ring
- EN 124 



PLANET



	DIMENSIONS					MASS		REFERENCE
	AxB	C	O	H	E	total	cover	
non-ventilated	785	643	608	100	93	41.3	26.5	CDPL60AZ
ventilated	785	643	608	100	93	41.3	26.5	CDPL60BZ

**PLANET
D400**



D400

ASTRA

- Ductile iron
- Round frame
- Hinged cover
- Ductile iron spring bar
- Ring in PEPP
- EN 124



→ Ring in PEPP



ASTRA

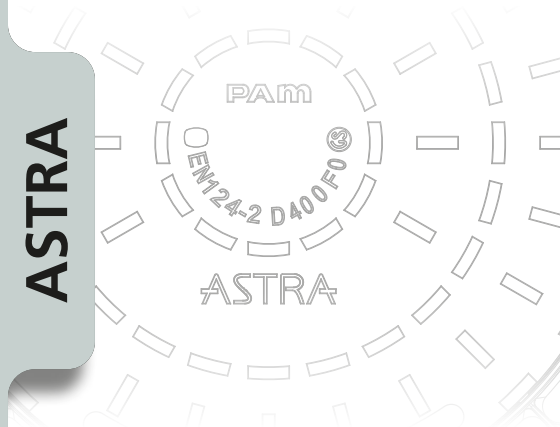

	DIMENSIONS					MASS		REFERENCE
	AxB	C	O	H	E	total	cover	
non-ventilated	725x685	624	605	100	96	36.0	24.0	CDAS60AD
ventilated	725x685	624	605	100	96	36.0	24.0	CDAS60BD

**ASTRA
D400**





G-TEX

D400

G-TEX

Ductile iron

Automatic locking by ductile iron spring bar

Pull and slide concept

Polyethylene ring

Optional anti-intrusion lock

EN 124  



→ Easy pull-and-drag handling

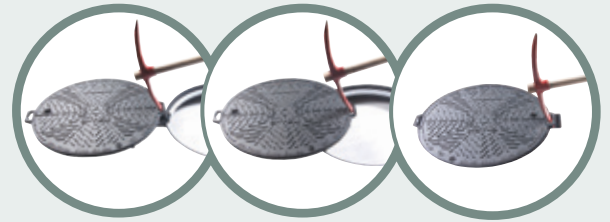

→ Operation

Unlocking, removal and reinstallation of the cover are carried out using a simple pickaxe, risk-free of pinching.

→ Strength

The G-TEX safety factor compared to EN124 requirements intends it for moderate traffic areas.

→ Stability

G-TEX offers a safe and stable automatic locking system combined with a polyethylene ring.

G-TEX



G-TEX
D400

TYPE	FRAME	MASS		DIMENSIONS		REFERENCE
		total	cover	clear opening	frame depth	
non-ventilated	round	57	33.5	600	100	CDGX60AF
ventilated	round	57	33.5	600	100	CDGX60BF
non-ventilated	square	63	33.5	600	100	CDGX60KF
ventilated	square	63	33.5	600	100	CDGX60LF

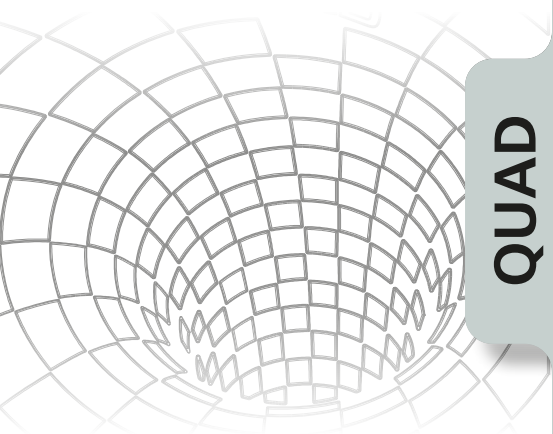

QUAD

D400



RECOMMENDED FOR USE IN: All square chambers connected to sewers, data & cable networks

QUAD

Ductile iron automatic locking, 2 spring bars

Hinged covers non ventilated

Dynamic stability systems for quiet use under all traffic conditions

Flanged frames compatible with Install Plus levelling devices

EN 124

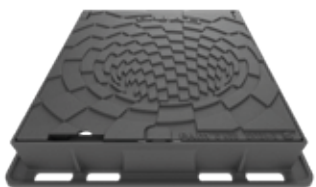
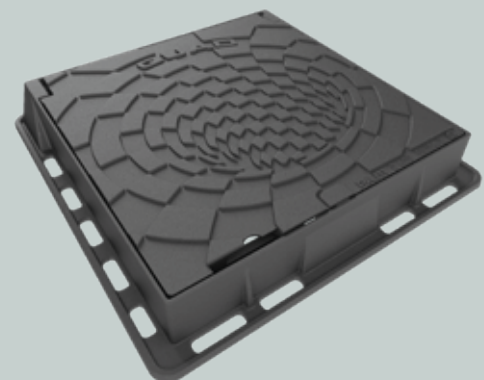

QUAD
D400

TYPE	FRAME	MASS		DIMENSIONS		REFERENCE
		total		clear opening	frame depth	
non ventilated	500x500	51,3		400	102	CDQD40KF
	600x600	57,8		500	102	CDQD50KF
	800x800	75		600	102	CDQD60KF



PARXESS

Ductile iron

Single sear cover

EN 124

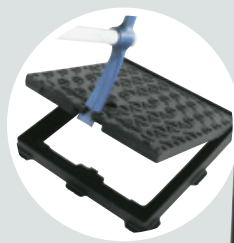

PARXESS



The new PARXESS single sear range is designed to provide an innovative, reliable and efficient response to new needs for access covers located in pavements and similar locations, where they may have to withstand the occasional load of passing vehicles. PARXESS offers the same benefits as AKSESS.

→ Ergonomics

- Convenient, easy opening and handling of cover.

→ Operation

- New cover seatings system with improved dynamic cover location within the frame.

→ Strength

- Frames and covers are designed to provide rigidity, resistance to deflection and durability.

→ Easy installation

- Wide flanged frames give optimal seating and efficient, durable bedding on square concrete boxes.

PARXESS

PARXESS C250



MASS		clear opening	DIMENSIONS		REFERENCE
total	cover		frame overall	frame depth	
24.4	14.5	430x450	300x300	56	CBPK40HF
32.3	20.7	530x550	400x400	56	CBPK50HF
40.6	31.0	630x650	500x500	56	CBPK60HF
55.6	40.0	730x750	600x600	56	CBPK70HF

PARXESS AR EN 124 C250



MASS		clear opening	DIMENSIONS		REFERENCE
total	cover		frame overall	frame depth	
44.0	26.0	592x670	508x430	80	CCPK50UZ

- Opening of 510x430 mm.
- Opens at 110 ° by double articulated system.

→ handling box on the front for ergonomic use with the usual tools

Identification of underground networks: four different caps are provided, each marked with a symbol representing an underground network, are available as an option.



IDENTIFICATION



DESCRIPTION	REFERENCE
plate of 4 identification caps	C42

DESCRIPTION	REFERENCE
locking kit PENTA without operating key	C41
operating key PENTA	C17

LOCKING KITS PARXESS



→ PENTA bolt and key

PAYSAGE 2



PAYSAGE 2

Hinged cover, 90° safety blocking,

Hinge restricting entry of soils

Handling box for pickaxe

Operating handle preventing opening without pick

Honeycomb frame for easy sealing

Lifting eyes on the frame for easy handling

Antitheft kit for frame and cover (optional)

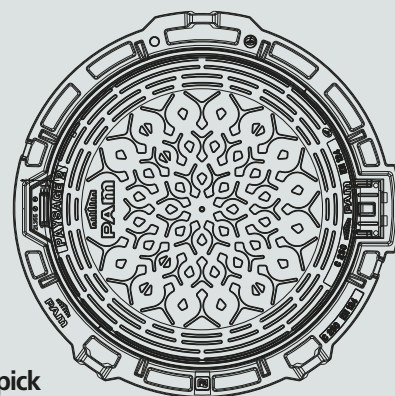

PAYSAGE 2
C250

TYPE	FRAME	DIMENSIONS			MASS		REFERENCE
		A	O	H	total	cover	
non-ventilated	round	830	600	75	43.92	24.80	CCPG60AF



TERRITORIALES by PAM

"TERRITORIALES BY PAM"

Four special versions to display and celebrate territories, cultural and regional identities.

To ensure the aesthetic coherence of sidewalks and squares, AKSESS and PAMREX are also available in «TERRITORIAL» versions.

MODEL	TYPE	FRAME	DIMENSIONS			MASS		REFERENCE
			A	O	H	total	cover	
triskell	non-ventilated	round	830	600	75	43.92	24.80	CCPG60AFM04
vines	non-ventilated	round	830	600	75	43.92	24.80	CCPG60AFM05
snowflakes	non-ventilated	round	830	600	75	43.92	24.80	CCPG60AFM06
wind rose	non-ventilated	round	830	600	75	43.92	24.80	CCPG60AFM07

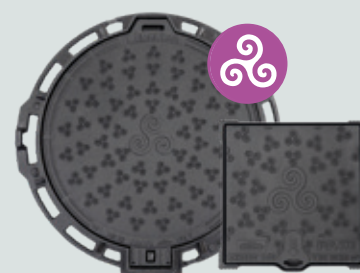
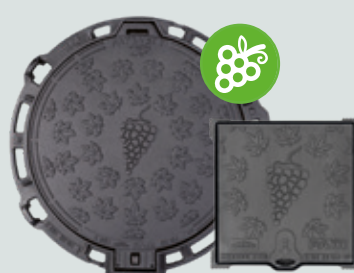
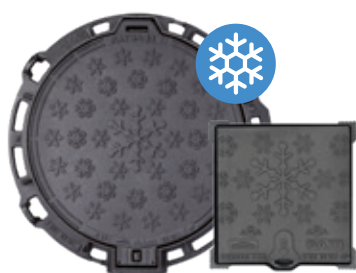

ANTI-THEFT SPLINE PAYSAGE 2

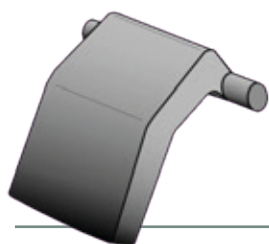

DESCRIPTION	REFERENCE
Spline alone	170900
Box with 1 spline and installation note	C38
Box with 10 splines (to equip 10 manhole covers)	C59

MANHOLES COVERS FOR INSPECTION CHAMBERS



HEIGHT ADJUSTABLE INSPECTION COVERS FOR PPIC

Ductile iron
Single seal

EN 124

These manhole covers are fitted on DN 400, DN 300 and DN 250 extensions installed on DN 300 and DN 250 inspection chambers.

The hinged cover is tamper-proof once bedded. Height adjustment up to 95mm by sliding the frame.

Units are fitted with earth-tight rings compliant with PVC / ductile iron extensions, see table for the appropriate code.



PIPE EXTENSION DN size mm	FRAME DIMENSIONS material	FRAME DIMENSIONS	MASS		DIMENSIONS		REFERENCE
			total	cover	clear opening	adjustability	
400	PVC	450	28.0	8.7	303	80	CCBR40BF
300	cast iron	360	20.0	6.0	225	95	CCBR30AF
	PVC						CCBR30BF
250	cast iron	318	15.5	4.5	181	95	CCBR25AF
	PVC						CCBR25BF



PIPE EXTENSION DN size mm	FRAME DIMENSIONS material	FRAME DIMENSIONS	MASS		DIMENSIONS		REFERENCE
			total	cover	clear opening	adjustability	
400	PVC	460	26.2	8.7	303	80	CCBR40SFX27
300	cast iron	380	19.0	6.0	225	95	CCBR30SFX26
	PVC						CCBR30SFX27
250	cast iron	330	14.5	4.5	181	95	CCBR25SFX26
	PVC						CCBR25SFX27

INSPECTION CHAMBERS



SQUARE FRAME C250



ROUND FRAME C250



AKSESS

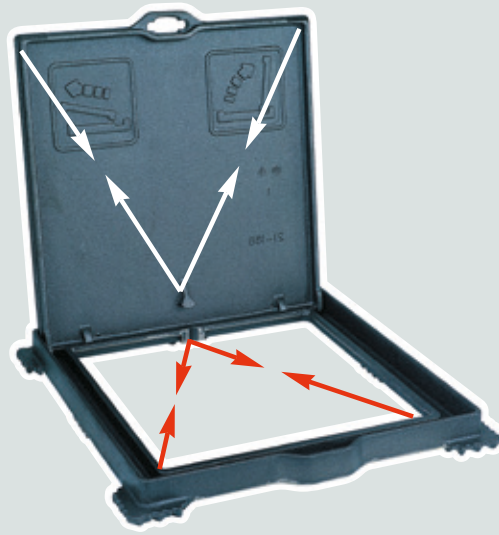

AKSESS: PAVEMENT SINGLE SEAL MANHOLE COVER

Ductile iron

Single seal manhole cover

EN 124  

Also available with
"Territoriales by PAM" cover designs.

For more information, see page 24.

Please consult for detailed products data.



AKSESS, FOLLOW THE STAR OF MANHOLE COVERS

STABLE, QUIET AND STRONG

→ Thanks to their perfect stability, AKSESS (water) manhole covers ensure quiet, trouble-free use for pedestrians and residents alike.

- 3-point non-rock system ensures the cover remains firmly seated in its frame
- Rigid and stable frames incorporating the LTS® system
- The underside of the wide seating pads located at each corner of the frame have a unique corrugated design that improves embedment and increases resistance to lateral shear by up to 5 times more than conventional designs

APPEARANCE

→ AKSESS is a range of attractive and functional manhole covers for pavement applications featuring:

- A new dynamic non-skid surface pattern
- A universal lifting point with integral usage indicator
- A specific diagram for the locked versions

EASY OPERATION

→ AKSESS, the fast and ergonomic solution for access to networks installed under pavements

- Opens effortlessly and remains stable in the vertical position in its frame
- Slides effortlessly for practical handling
- The lifting point for non-locked AKSESS covers is ergonomic and designed for use with standard tools

LOCKED AKSESS COVERS

SECURITY AND THEFT DETERRENCE

→ The locked version of AkseSS covers meets specific requirements for the prevention of theft, vandalism and intrusion

- Protection of appliances and equipment installed under pavements
- Deterrent against cover theft
- Locked AKSESS covers have a special opening that can only be operated using the AKSESS key, which operates the special 1/4-turn lock

→ **Guaranteed protection of your equipment.**

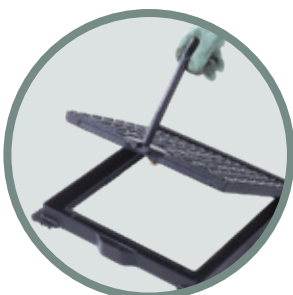

TYPE	DIMENSIONS			MASS total	REFERENCE
	outside of frame	clear opening	frame height		
STANDARD version (non locked)					
AKSESS 300	310x310	220	37	8.2	CBAK30HF
AKSESS 400	410x410	300	37	11.8	CBAK40HF
AKSESS 450	460x460	350	38	14.8	CBAK45HF
AKSESS 500	510x510	400	38	18.4	CBAK50HF
AKSESS 550	550x580	450	38	26.0	CBAK55HF
AKSESS 550x 700	560x710	450x600	38	32.9	CBAK75HF
AKSESS 600	610x610	500	38	30.3	CBAK60HF
AKSESS 700	720x720	600	38	43.8	CBAK70HF
AKSESS 800	820x820	700	41	56.4	CBAK80HF

AKSESS STANDARD B 125



TYPE	DIMENSIONS			MASS total	REFERENCE
	outside of frame	clear opening	frame height		
Locked version					
AKSESS 300	310x310	220	37	8.2	CBAK30HFX16
AKSESS 400	410x410	300	37	11.8	CBAK40HFX16
AKSESS 450	460x460	350	38	14.8	CBAK45HFX16
AKSESS 500	510x510	400	38	18.4	CBAK50HFX16
AKSESS 550	550x580	450	38	26.0	CBAK55HFX16
AKSESS 550x 700	560x710	450x600	38	32.9	CBAK75HFX16
AKSESS 600	610x610	500	38	30.3	CBAK60HFX16
AKSESS 700	720x720	600	38	43.8	CBAK70HFX16
AKSESS 800	820x820	700	41	55.2	CBAK80HFX16

AKSESS LOCKED B 125



DESCRIPTION	REFERENCE
AKSESS handling key	C17

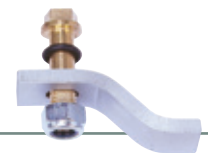

AKSESS AR

Articulated cover, opening at 110°

Handling box

Frame with notched flange enabling an effective bedding

Compatibility with standardized concrete forms

Anti-theft protection optional

Possibility of epoxy coating (on request)

Possibility of custom marking (on request)

FRAME	DIMENSIONS		MASS		REFERENCE
	clear opening	frame depth	total	cover	
square	510x430	39	32.0	21.0	CBAK50UZ

AKSESS AR EN 124 B 125

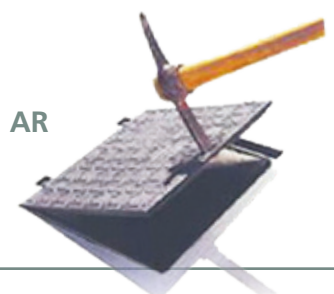

OTHER B125 MANHOLE COVERS

SQUARE SINGLE SEAL MANHOLE COVER

B 125

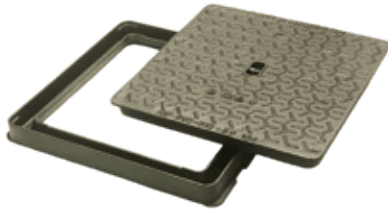

FRAME DIMENSIONS mm	MASS		DIMENSIONS		REFERENCE
	total	cover	clear opening	frame depth	
Square frame with square cover					
250	6.8	3.9	188	29	CBHY25HF
300	8.6	5.0	233	29	CBHY30HF
415	12.2	7.4	329	30	CBHY40HF
520	25.2	14.2	404	39	CBHY50HF
600	38.2	23.9	500	48.5	CBHY60HF
700	50.3	33.0	601	48.5	CBHY70HF
830	69.0	48.0	700	50	CBHY80HF

CIRCULAR SINGLE SEAL MANHOLE COVER

B 125



FRAME DIMENSIONS mm	MASS		DIMENSIONS		REFERENCE
	total	cover	clear opening	frame depth	
Round frame with round cover					
360	9.2	5.6	250	30	CBHY36SF
437	11.6	7.3	340	30	CBHY40SF
537	20.9	12.0	407	48	CBHY50SF
705	39.4	27.4	600	60	CBHY70SF

PAVEMENT MANHOLE COVER WITH SQUARE FRAME

B 125



FRAME DIMENSIONS mm	MASS		DIMENSIONS		REFERENCE
	total	cover	clear opening	frame depth	
Square frame with round cover					
250	3.8	1.2	150	16	CBTB25RF
300	5.4	1.6	175	16	CBTB30RF
400	10.1	3.8	250	17	CBTB40RF
500	16.6	5.9	350	29	CBTB50CF
600	23.0	9.5	425	29	CBTB60RF
700	36.0	15.0	500	34	CBTB70RF
830	50.8	24.3	610	35	CBTB80CF

PAVEMENT MANHOLE COVER WITH CIRCULAR FRAME

B 125



FRAME DIMENSIONS mm	MASS		DIMENSIONS		REFERENCE
	total	cover	clear opening	frame depth	
Round frame with round cover					
500	12.5	5.9	350	30	CBTB50RF
800	36.8	24.3	610	35	CBTB80RF

TEK

B125

TEK

Automatic locking by spring bar

Hinged cover, opens to 115°

Optional locking system

TYPE	FRAME	MASS		DIMENSIONS			REFERENCE
		total	cover	frame overall	clear opening	frame depth	
ventilated	round	46.0	26.0	785	600	100	CBTE60DU
non-ventilated	round	46.0	26.0	785	600	100	CBTE60EU

TEK
B125
ÜA



B125

PASSUS

Ductile iron according to ISO 1083
with bituminous coating

PE ring

EN 124

FRAME	MASS		DIMENSIONS		REFERENCE
	total	cover	clear opening	frame depth	
round	27.5	17.2	600	70	CBPU60EZ

- Opening 600mm. Opens at 100° with 90° safety lock.
- Automatic locking system with elastic bar made of ductile cast iron.

→ Working area

- Class B125 (Group 2) according to EN124 standard, sidewalks, pedestrian zones and comparable areas, parking areas and car parking spaces.
- Inspections and periodic network visits.

→ Options

- Locking system optional.
- Anti-theft protection optional.
- Possibility of epoxy coating (on request).
- Possibility of custom marking (on request).

PASSUS

PASSUS
B125



B125

OPTEA

Ductile iron

Single seal function

EN 124

FRAME	MASS		DIMENSIONS			REFERENCE
	total	cover	frame overall	clear opening	frame depth	
square	5.9	3.7	300	235	25	CBOP30HK
	9.2	6.4	400	325	25	CBOP40HK
	15.0	11.0	500	400	30	CBOP50HK
	24.2	19.6	600	500	30	CBOP60HK

OPTEA

OPTEA
B125



INTERACTIVE
CATALOGUE
Pass the trackball
on a product code
and you automatically
access to its data sheet!



HOW TO INSTALL D400 MANHOLE COVERS

Installation guides, bedding instructions provide recommendation & best practices for the installation of manhole covers & gratings are available for download in various languages.



BEDDING BEST PRACTICES

- ❑ **Wear** all personal safety equipment and follow all safety instructions on job site

Safety equipment

- ❑ **Use** appropriate tools
- ❑ **Control** dimensional fit between frame and chamber head
- ❑ **Read and follow** PAM's instructions
- ❑ **Read and follow** instructions for bedding mortar
- ❑ **Utilise** specified product mix, use clean and correct temperature water
- ❑ **Clean** any operational parts of the manhole cover, keeping installation area clear
- ❑ **Allow** bedding mortar sufficient time to set, before reopening to traffic
- ❑ **Consider** jobsite's cleanliness, collect and discard all debris, packaging and waste

IMPORTANT NOTICE

■ This document provides contractors with advice and recommendations useful for the bedding of PAM ironwork. These recommendations are indicative only and should not prevent contractors from adopting bedding practices according to site conditions. Contractors remain exclusively responsible for their job and for the full adherence to safety instructions during bedding operations.

■ This document does not address either the installation of "self levelling" frames, nor the use of flowable mortars for bedding of tradition ironwork. Dedicated documents for these applications will be issued at a later date.

DIMENSIONAL MATCHING

1 Check that internal and external dimensions of the top of the chamber comply with the dimensions of the frame to be embedded, so that it is supported/seated.

9 Lay the frame, well-centered and horizontal, directly on the bedding material, gently hammering (using also a wooden block) the frame to make it progressively sink into the bedding material.

10 If the frame sinks too deeply into the bedding material, remove the frame, add another layer of bedding material, and proceed again according to n°8 and n°9.

11 Check the bedding material is filled to the top of the frame.

12 Lay a trowelled surface on top of the bedding material up to the top of the frame.

FINISH AND CHECK

13 Check the manhole cover is never under the road surface.

Videos also available.
Please consult your local Saint-Gobain PAM.



Download...



Continental types of products, circular frames

UK double triangular products, square / rectangular frames

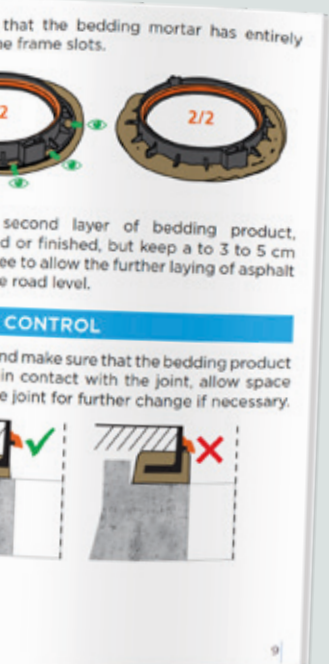



T-MAX

D400

DUCT COVERS T-MAX i D 400

→ Built-in hinge into the basic version:

- Covers lifted horizontally by 2 operators using lifting hammers
- Hinging: allows cover opening by one operator
- 90° safety blocking position

→ 100% ductile iron frame:

- Ductile iron frame welded by robots
- Total height 120 mm

→ Retrofit of safety or opening assistance devices:

- To be installed further to the bedding of the unit
- Quick & easy installation, no preparation required
- Mounting just requires hammer & 19mm-wrench, Instruction notice provided

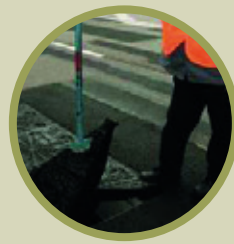

DUCT COVER T-MAX
D 400



→ K2C

CHAMBER TYPE	Nr of COVERS	C x O	MASS	PACKING	REFERENCE	
					with telecom logo	without logo
D 400 type K - Ductile iron frame and triangular with built-in-hinge						
K1C	2	750 x 750	128.5	4	DDK1ARTXTEL	DDK1ARTX
K2C	4	1500 x 750	238.0	4	DDK2ARTXTEL	DDK2ARTX
K3C	6	2250 x 750	349.0	4	DDK3ARTXTEL	DDK3ARTX

KITS T-MAX to be installed on site

→ Unit Installation manual included



Ask for the specific catalogue.



TYPE	DESCRIPTION	MASS	REFERENCE
D 400 type K - Ductile iron frame and triangular with built-in-hinge			
Opening assistance kit for 2 covers ⁽¹⁾	2 anti-ejection clips to be screwed on the frame 2 oscillating fasteners to be installed under the cover 2 gas springs with stainless steel quick couplings	2.8	D28
Safety kit for K1C duct cover	Lock with SCS head ⁽²⁾ Safety clamp for master cover 2 safety clamps for slave covers	2.2	D25
Safety kit for K2C duct cover	Lock with SCS head ⁽²⁾ Safety clamp for master cover 6 safety clamps for slave covers	4.0	D26
Safety kit for K3C duct cover	Lock with SCS head ⁽²⁾ Safety clamp for master cover 10 safety clamps for slave covers	5.8	D27
SCS key for safety kit		0.4	C18

⁽¹⁾ If assistance is required for all covers, order 2 kits for a K2C duct cover and 3 for a K3C duct cover

⁽²⁾ Other locks are developed for special work sites or specific operators.

COVER LIFTING HAMMER



DESCRIPTION	REFERENCE
FT homologated plate hammer	D10
Simplified plate hammer	D11



DUCT COVERS T-MAX i C250

→ Standard units with possible retrofit options:

- Optional features available as retrofit patented kits; for a quick & reliable installation
- Prefabricated galvanised steel frames already prepared for further retrofit of optional kits, Ductile iron covers, seatings fitted with sound-proof pads

CHAMBER TYPE	Nr of COVERS	CxO	MASS	PACKING	REFERENCE	
					with telecom log	without logo
C250 type L1T to L4T - Optimised steel angle bar frame and ductile iron covers						
L1T	1	527x389	38.3	5	DCL1TMIXTEL	DCL1TMIX
L2T	2	1161x389	71.7	5	DCL2TMIXTEL	DCL2TMIX
L3T	3	1381x527	101.3	5	DCL3TMIXTEL	DCL3TMIX
L4T	4	1876x527	132.6	5	DCL4TMIXTEL	DCL4TMIX
1/2L4T	2	884x527	69.9	5	DC1LTMIXTEL	DC1LTMIX
C250 type P2T to M2T - Optimised steel angle bar frame and ductile iron covers						
L1T	2	1161x884	146.7	5	DCP2MIXTEL	DCP2TMIX
L2T	3	1795x884	214.6	5	DCL5MIXTEL	DCL5TMIX
L3T	4	2429x884	282.7	5	DCL6MIXTEL	DCL6TMIX
L4T	5	3062x884	350.8	5	DCM2MIXTEL	DCM2TMIX

Retrofit kits to be installed further to the bedding of the unit

CHAMBER TYPE	SAFETY	HINGE	CHAMBER TYPE	SAFETY	ASSISTED OPENING
L1T	1 kit D29	0	P2T	1 kit D31	1 kit D32
L2T & 1/2 L4T	1 kit D29	1 kit D30	L5T	2 kits D31	1 kit D32
L3T	1 kit D29	2 kits D30	L6T	2 kits D31	2 kits D32
L4T	2 kits D29	2 kits D30	M2T	3 kits D31	2 kits D32

□ The kits quantity to be ordered depending on the type of chamber



DUCT COVERS T-MAX optimised C250 or B 125

→ Angle bar frame: galvanized steel 50x30x5 mm
C250 type LOT / C250 type L1T to L4T

CHAMBER TYPE	Nr of COVERS	DIMENSIONS outside frame	O x L	MASS	PACKING	REFERENCE	
						with telecom log	without logo
C250 type L1T - Steel angle bar frame 50x30x5 mm and optimised frame 578x468 mm fitted with sound-proof pad							
LST1	1	641x481	581x421	28.0	10	DCL1LIGXTEL	DCL1LIGX
L2T	2	481x1221	1161x421	53.5	5	DCL2LIGXTEL	DCL2LIGX
L3T	3	591x1469	1409x531	77.7	5	DCL3LIGXTEL	DCL3LIGX
L4T	4	591x1938	1878x531	102.4	5	DCL4LIGXTEL	DCL4LIGX
1/2L4T	2	591x1000	940x531	52.8	5	DC1LLIGXTEL	DC1LLIGX
C250 type LT - Steel angle bar frame 50x30x5 mm and optimised frame 578x468 mm fitted with sound-proof pad							
LOT	1	308x488	428x248	13.4	10	DBL0LIGXTEL	DBL0LIGX



DUCT COVER T-MAX C250

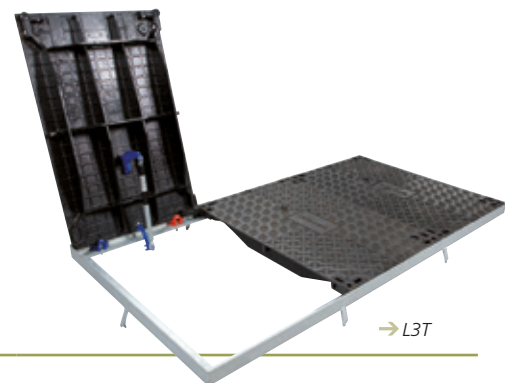

Ask for the specific catalogue.

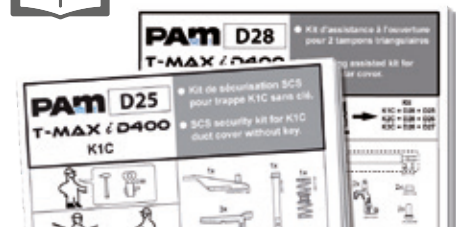

DUCT COVER T-MAX OPTIMISED C250

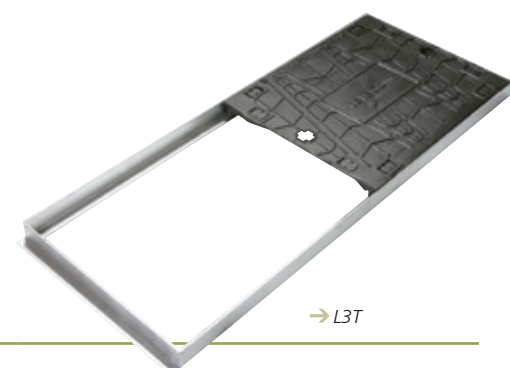



PAMETIC2

F900

E600

D400

C250

B125

DUCT COVERS PAMETIC

Specific areas like: airports, bridges, industrial sites, laboratories, ... require a high level of sealing on duct covers for pit and specific chambers

→ 3 main fields of application:

- Sealed duct covers with 1 to 3 covers on a row
- Sealed access covers for technical channels
- Sealed multispan duct covers

→ Performances :

- The bearing surface between frames and covers is completely machined : the precision of the components and the absence of gap provide sealing, stability and complete silence
- Water and odours tight sealing assisted with special sealing grease
- Easy and safety opening with handling keys
- For multispan duct covers possibility of opening the selected cover

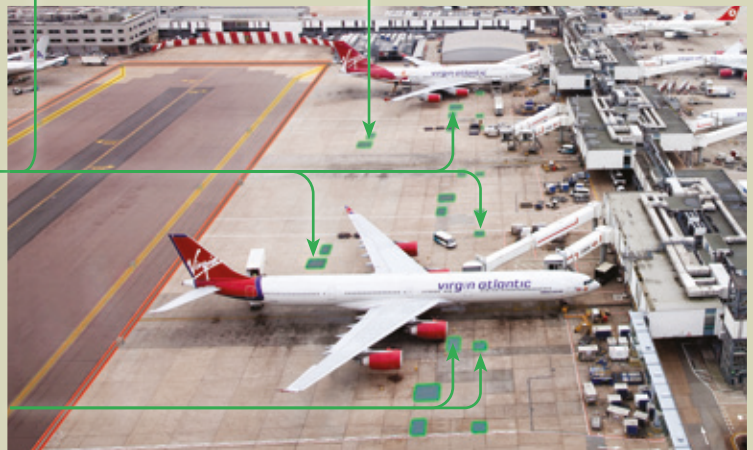
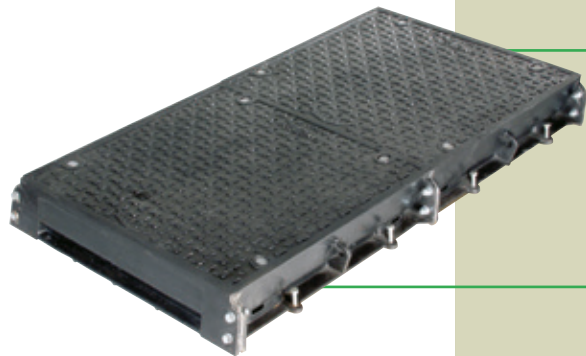
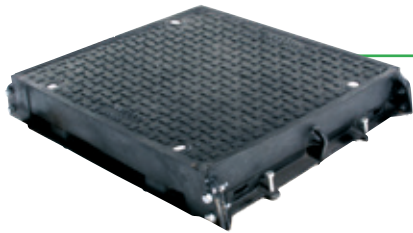

- **Gas & Water tightness:** contact surfaces between covers and frames / beams are machined.
- **Stability:** accuracy of machined seatings prevent covers from any movement or rocking, for safe, reliable & durable life span in toughest conditions.
- **Resistance and stiffness:** both single units and multi-covers ducts or channels are built with extremely resistance frames, beams & covers, tested in accordance with EN 124.
- **A comprehensive range of solutions,** making every project a tailor-made achievement, with specific load classes, dimensions, layouts, and covers surfaces: full ductile or ductile recessed tops
- **Dimensioning software** allow precise calculation of BOM (quantification of covers, frames, beams, etc.)

→ Please consult us for any further technical data, technical sheets, assistance or quotes, bespoke or standard.



F900



PAMETIC
G.GATIC

→ Gas arm-fitted F900 gas & water tight units, to provide man / material entry on airport tarmacs & taxiways, in safe & easy lifting conditions.

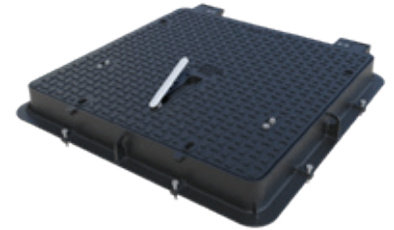

	DIMENSIONS		MASS total	REFERENCE
	outside of frame	clear opening		
	983 x 958	750 x 750	118	DFAL75AX75X99
	1133 x 1108	900 x 900	118	DFAL90AX90X99
	1288 x 1282	1000 x 1000	154	DFAL10AX10X99



PAMETIC
G.GATIC

→ Gas arm-fitted covers allow easy a painless opening and closing, without loss of stability and resistance.

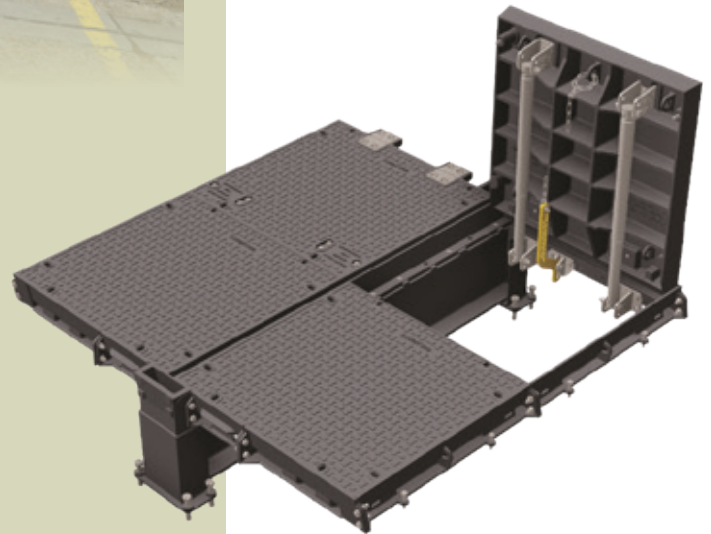
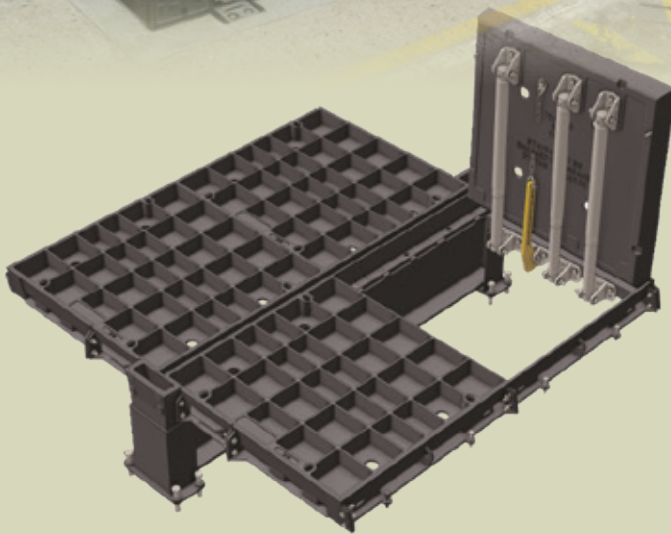

The Pametic 2 ranges comprise more than 6.000 product codes, depending on classes, sizes, combinations possibilities etc.

As a consequence, it is not possible to fully display the ranges contents and data. Therefore, we thank you to contact your local Saint-Gobain PAM sales organisations to get access to the products details.

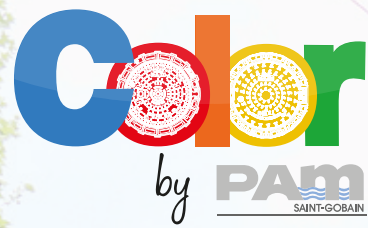

TREE GRATES

Materials

Ductile iron grates, galvanised steel frames.

Aesthetical

140-colors choice allows covers & gratings to fade away in the urban landscape or to bring nice colour touch.

Durability

Zinc-alu protection ensures heavy **anti-corrosion resistance** prior to coating. Tested at 280 bar, withstands high pressure jetting on public places, market places, etc.

Ergonomics

Color by PAM allows to avoid the use of heavy covers filled with pavement to match surroundings.

→ Tree grates coating is as standard dark grey, from the Color by PAM range



HIGH PROTECTION FLAT GRIDS

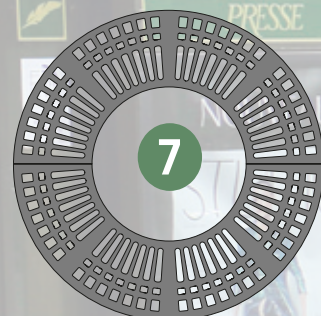
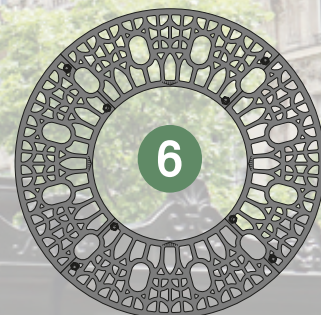
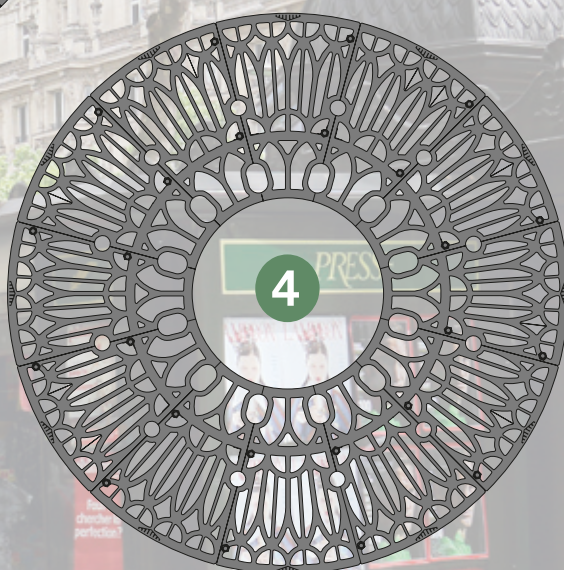
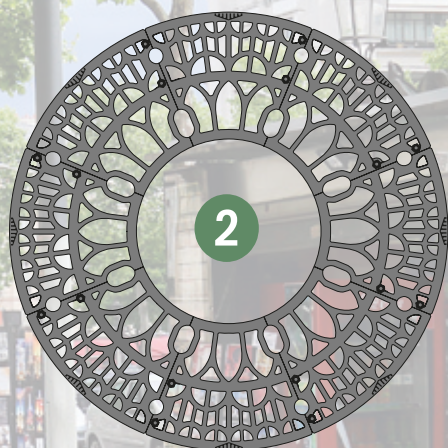
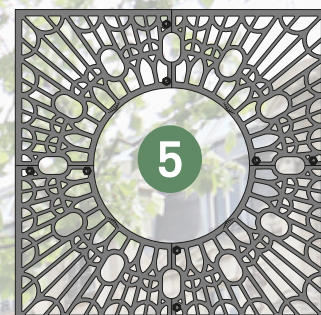
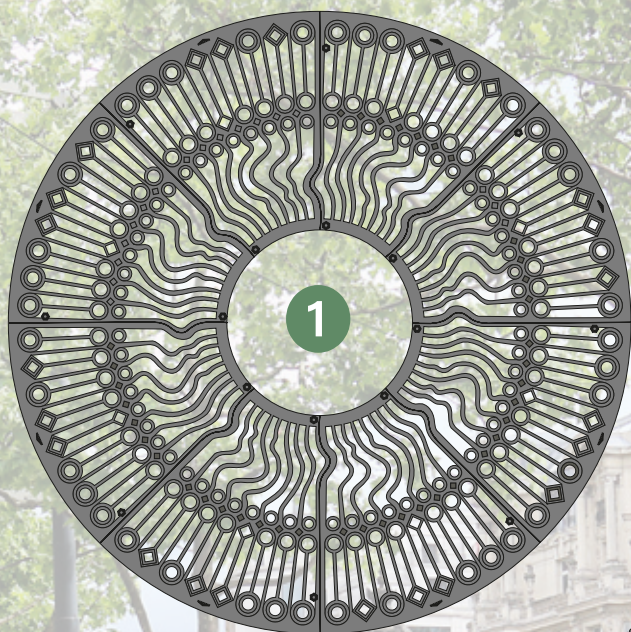

TYPE	Ø EXT.	Ø INT.	TOTAL MASS	Nr of PARTS	REFERENCE
------	--------	--------	------------	-------------	-----------

ETNA grate

grate	1200	400	51.0	4	EAET12
frame	-	-	4.0	4	E0ET12C

SANTORIN grate

grate	1450	740	72.0	4	EASA14
frame	-	-	6.0	4	E0SA14C

KILIMANDJARO grate

grate	1720	1000	93.0	4	EAKI17
frame	-	-	6.0	4	E0KI17C

TYPE	Ø EXT.	Ø INT.	TOTAL MASS	Nr of PARTS	REFERENCE
------	--------	--------	------------	-------------	-----------

1 DESLANDES	grate	2000	600	176.0	4	EADE20
	frame	-	-	6.0	4	EODE20C
2 MONET	grate	1414	600	60.0	2	EAMO14
	frame	-	-	11.0	4	E0MO14C
3 FANTIN-LATOURE	grate	1414	600	78.0	4	EAF14
	frame	-	-	8.0	4	E0FL14C
4 DAUBIGNY	grate	1800	600	102.0	4	EADA18
	frame	-	-	7.0	4	E0DA18C
5 GAUGUIN	grate	1000	500	34.0	4	EAGA10
	frame	-	-	5.6	4	E0GA10C
6 CEZANNE	grate	1000	500	30.0	4	EACE10
	frame	-	-	4.0	2	E0SE10C
7 SEURAT	grate	1000	500	54.0	2	EASE10
	frame	-	-	4.0	2	E0SE10C

GULLY GRATES

The collection of run-off water has become a major concern :

- the development of impermeable surfaces considerably increases the volumes to be drained,
- while, at the same time, sewer system operating constraints are changing user needs, especially with regard to the filtering of debris and access for maintenance operations.

On the strength of its recognized experience in sewerage and its know-how as the leading European manufacturer of municipal castings, **PAM** offers a range of drain gratings that provide users with efficient, reliable and durable solutions. Always attentive to customer needs, **PAM** is constantly seeking to improve its product ranges to satisfy future requirements.

	GRATING GATIC for airport F900	page 41
CIRCULAR GRATINGS	PAMREX	page 42
	REXEL PAYSAGE	page 43
	AQUAMAX AQUAVANTAGE	page 44
SQUARE GRATINGS	DEDRA	page 45
	SQUADRA	pages 46/47
	ITALIA LAZIO MILANO	page 48
SQUARE GRATINGS FOR KERBSIDES AND CAR PARKS	Traditionnal flat gratings Concave gratings	page 49
	SOLE ESKOA	page 50
RECTANGULAR GRATINGS	SELECTA	pages 51/53
	GULLY UNITS	Gully covers Gully gratings COMMUNAL
LONGITUDINAL CHANNEL GRATINGS	OPTEA Other channel gratings	page 55
	AUTOLINEA	pages 56/57
GRATINGS FOR CROSSWISE CHANNEL	TRANSLINEA MECALINEA	pages 58/59
SURFACE BOXES	PAVA Other surface boxes	pages 60/61

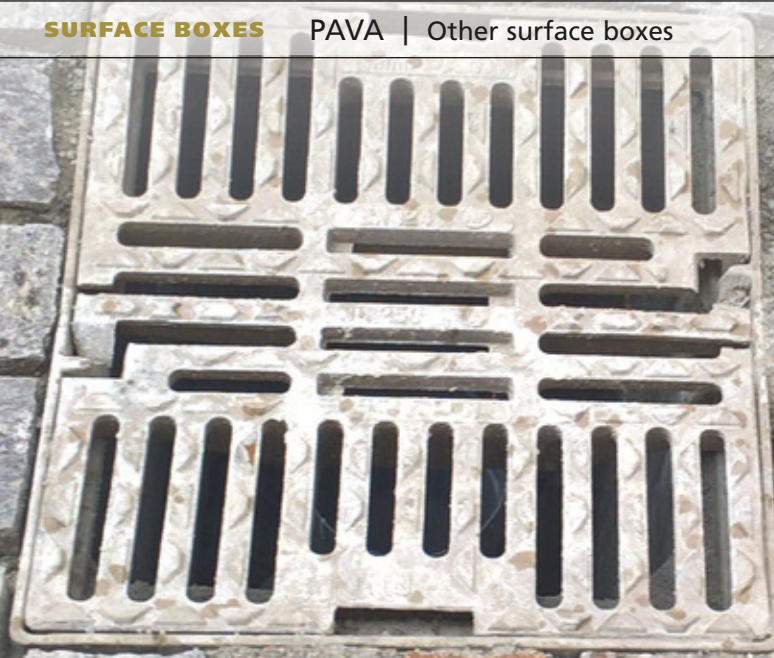

SELECTION CRITERIA FOR GULLY GRATES

TYPE OF COLLECTION

Run-off water can be collected either :

- by gully grates in a road carriageway or in a parking area, or by kerbside gully units.
- Linear collection, by channel gratings.

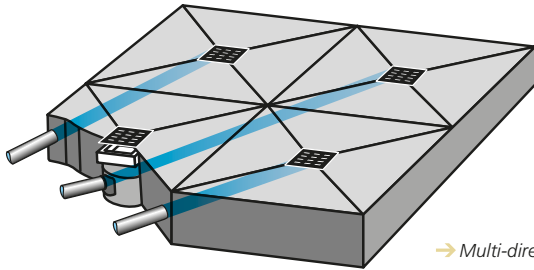

→ Multi-directional drainage

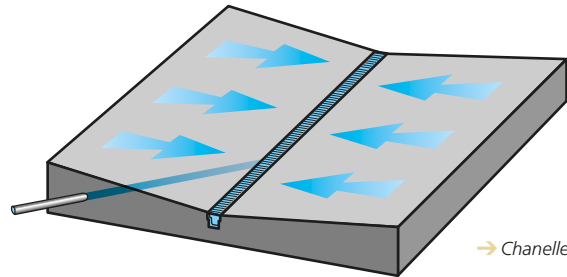

→ Channelled drainage

LOCATION OF GULLY POT

The type of grating to be used is generally determined by the location of gully pots and the design of the drainage network.

- When the gully pot is situated directly under the carriageway, a square flat grating is used.
- When the gully pot is positioned to provide kerb and carriageway drainage, either a gully grate or a SELECTA inlet should be used.

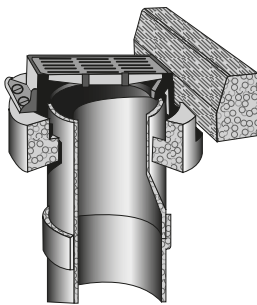

→ Gully pot positioned under carriageway

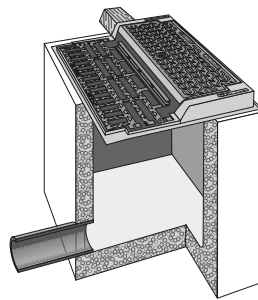

→ Kerb or carriageway combination

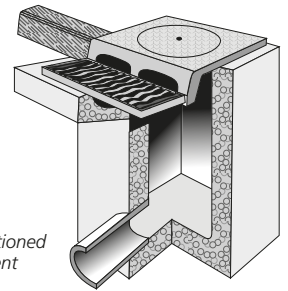

→ Gully pot positioned under pavement

TRAFFIC RESISTANCE

Like manhole covers, gully grates must be selected according to their place of installation as this determines their strength class in accordance with the definition in EN 124 (see page 3).

FLOW CAPACITY SELECTION SOFTWARE

In order to help customers make their choice among the various gully units, frame gratings and channel gratings in the gully grates range, Saint-Gobain PAM has prepared a dimensioning and decision-making aid software package.

It can be used to determine the following points on the basis of the characteristics of the site studied :

- the type of grates,
- the number of grates to be used,
- the spacing between two successive castings,
- the quantity of rainwater drained by the sewer system.

Please consult our sales engineering teams.



SELECTION CRITERIA FOR GULLY GRATES



To meet national regulations addressing disabled people (PMR) access conditions to public areas, Saint-Gobain PAM proposes a wide range of flat & concave gratings featuring reduced slots widths and apertures diameters.

These gratings bear the logo 

RANGE

Confronted to the wide diversity of situations encountered, users are increasingly choosing specific drain inlet devices in order to optimize the collection of rainwater.

In response to this demand, Saint-Gobain PAM provides a wide range of products constituting suitable technical solutions for each specific configuration.

According to EN 124:2015, D400 concave gratings have restricted places of installation: parking areas only

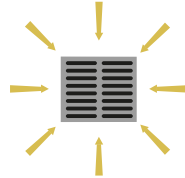

multidirectional drainage

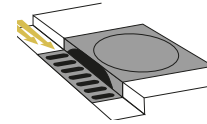



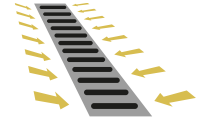



kerbside drainage



longitudinal drainage

TYPE OF DRAINAGE

CLASS	TRAFFIC RESISTANCE	TYPE OF DRAINAGE			CHANNEL
		Multidirectional	Kerbside	Longitudinal	
CLASS E600					TRANSLINEA channel
CLASS D400	Reinforced stability	PAMREX 	DEDRA* flat  DEDRA* concave**	AQUAMAX* flat AQUAVANTAGE concave**	TRANSLINEA channel
	Standard	REXEL* 			AUTOLINEA* channel
CLASS C250	Reinforced stability		SQUADRA* flat 	SELECTA* gully units 	AUTOLINEA* channel
			SQUADRA* concave** 	SELECTA* kerb 	
	Standard	PAYSAGE	TRADITIONNAL flat	gully gratings rectangular flat gratings	MECALINEA channel
			TRADITIONNAL concave	simple gullies and cover plates	

* with spring bar locking

** according to EN 124:2015, D400 concave gratings have restricted places of installation: parking areas only

GRATING GATIC FOR AIRPORTS

F900

Ductile iron

**Machined and greased
seating faces**

**2 levelling bolts
on each side bar
(level setting)**



GATIC



GATIC GRATING F900



TYPE	DIMENSIONS		MASS total	REFERENCE
	clear opening	outsideframe		
Grate with frame		900x570x140	107.5	EFGR83ZX
Grate on 2 side bars	850x300	850x570x140	85.0	EFCL30JX
End plate*		-	5.5	E14
Grate with frame		900x720x140	135.8	EFGR84ZX
Grate on 2 side bars	850x450	850x720x140	108.0	EFCL45JX
End plate*		-	7.0	E15
Grate with frame		900x870x140	191.1	EFGR86ZX
Grate on 2 side bars	850x600	850x870x140	210.0	EFCL60JX
End plate*		-	8.5	E16
Grate with frame		750x1020x140	270.3	EFGR77GX
Grate on 2 side bars	700x750	700x1020x140	228.0	EFGR77JX
End plate*		-	10.0	E17

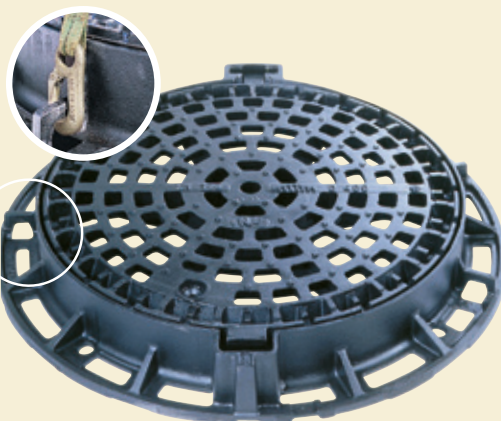

* for channel application : use gratings with side bars and 2 end plates

PAMREX



D400

PAMREX GRATING

- Ductile iron
- Hinged
- 1 handling box
- Lifting rings integral with the frame
- Optional anti-theft grate locking
- Interchangeable with PAMREX cover
- EN 124  

PAMREX SAFETY «PMR» FOR DISABLED PEOPLE D400



FRAME	MASS		DIMENSIONS		WATERWAY AREA dm ²	REFERENCE
	total	grating	clear opening	frame depth		
round	87.2	58.0	610	100	10.75	EDPA60AF
square	97.8					EDPA60

- Cover opening to 130°
- Blocks at 90° when closing

INTERACTIVE CATALOGUE

Pass the trackball on a product code and you automatically access to its data sheet!



D400

REXEL GRATING

Ductile iron

Automatic locking by ductile iron spring bar (patented system)

Hinge

Unlocking box

Optional anti-theft grate locking

Rexel grate is interchangeable with cover

EN 124  

REXEL

REXEL GRATING «PMR»

FOR DISABLED PEOPLE

D400

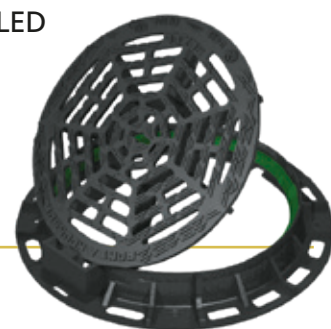

FRAME	MASS		DIMENSIONS		WATERWAY AREA dm ²	REFERENCE
	total	grating	clear opening	frame depth		
circular	57	32	600	100	11.9	EDRX 60BF
square	65	32	600	100	11.9	EDRX 60DF

- The REXEL grating is specially designed to withstand medium-density traffic. Its design ensures performance, long-life and stability.

C250

PAYSAGE GRATING

Ductile iron

Polyethylene ring

Interchangeable with PAYSAGE cover

EN 124  

PAYSAGE

PAYSAGE GRATING «PMR»

FOR DISABLED PEOPLE

C250

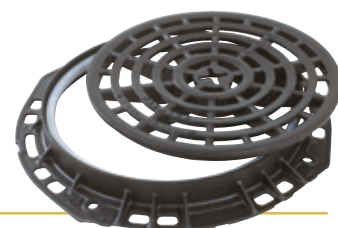

FRAME	MASS		DIMENSIONS		WATERWAY AREA dm ²	REFERENCE
	total	grating	clear opening	frame depth		
circular	56	36	600	75	13.5	ECPG60BF
square	63	36	600	75	13.5	ECPY60DF

- The PAYSAGE grating is installed on shafts sited in traffic-free locations.
- The concave shape of the concentric bars optimizes multi-directional collection.

AQUA-MAX



AQUA-MAX

- Ductile iron
- Hinged and locked grating
- Multi-directional wedge
- Integral spring Bar
- LTS Feature
- EN 124



AQUA MAX
D 400



CLEAR OPENING	OVERBASE	DEPTH	TOTAL MASS	WATERWAY AREA dm ²	REFERENCE
450x450	660x550	100	45.5	12.4	205864
450x450	660x550	150	50.0	12.4	205865

AQUAVANTAGE



AQUAVANTAGE

- Ductile iron
- Captive Hinged Grating
- Spring bar locking feature as standard
- Optional retro-fit locking kit
- V Profile
- EN 124



AQUAVANTAGE
D 400



CLEAR OPENING	OVERBASE	DEPTH	TOTAL MASS	WATERWAY AREA dm ²	REFERENCE
600x600	738x742	150	81.5	22.0	234850
600x600 (*)	738x742	150	81.5	52.5	242564
900x900	1050x1020	180	183.6	48.8	241255
675x1200	830x1355	150	188.0	51.1	251830
1200x675	1356x809	200	180.0	51.1	251829

(*) removable grate version according to EN 124:2015, D400 concave gratings have restricted places of installation: parking areas only

D400

DEDRA HINGED GRATING

Ductile iron

Hinged spring-bar locked gratings

Disabled / not disabled options

Frames with 3 flanges

(kerb installation)

4 flanges

(installation on square chambers)

Frames fittable / not fittable with mud pan





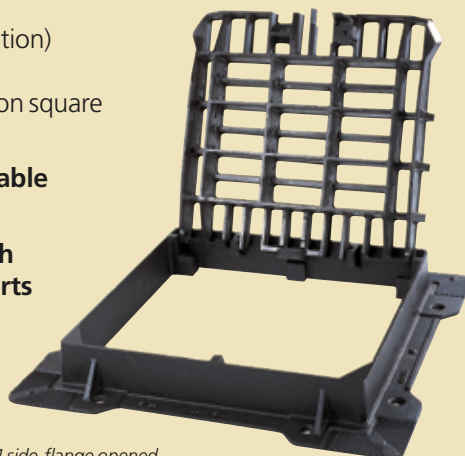

Frames can be fitted with Install Plus levelling inserts

LTS Feature

EN 124 



→ Frame 4 side-flange opened

FRAME	MUDPAN	MASS total	WATERWAY area dm ²	DIMENSIONS			REFERENCE
				frame	clear opening	frame depth	
flat grating for disabled people (PMR)							
4 side-flanged 	no	31,6	8,6	450x450	300	102	EDDE30EFX11
3 side-flanged 	compatible	60	8,1	600x450	350	102	EDDE35IFX11
3 side-flanged 	no	60	8,1	600x600	400	102	EDDE40IFX11
4 side-flanged 	compatible	53	8,1	600x450	350	102	EDDE35EFX11
4 side-flanged 	no	54	8,1	600x600	400	102	EDDE40EFX11
4 side-flanged 	no	63,6	10,5	650x650	500	102	EDDE30EFX11
4 side-flanged 	no	91,9	16,2	750x750	600	102	EDDE60EFX11
flat grating							
3 side-flanged	no	85		800x714	600	102	EDDE60RFX14
4 side-flanged	no	88		800x800	600	102	EDDE40EFX11
concave grating							
4 side-flanged	compatible	60	11,3	600x600	400	127	EDDE40DFX15
4 side-flanged	no	55	11,3	600x600	350	127	EDDE35DFX15

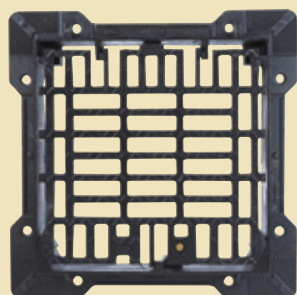

→ Frame 4 side-flange

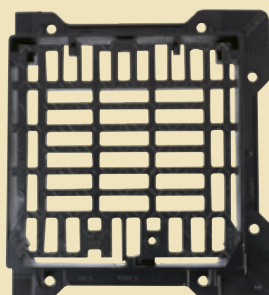

→ Frame 3 side-flange

DEDRA

DEDRA

DEDRA 600 FLAT & CONCAVE* NEW DEDRA D400

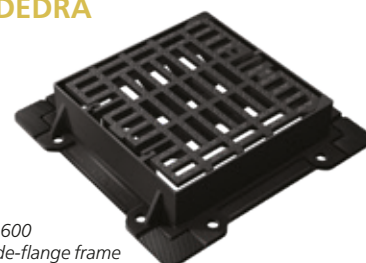

→ DEDRA 600
flat 4 side-flange frame



→ DEDRA 400
concave 4 side-flange frame

*according to EN 124:2015, D400 concave gratings have restricted places of installation: parking areas only

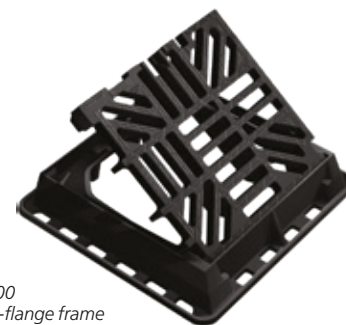

→ DEDRA 400
flat 4 side-flange frame

SQUADRA GRATINGS WITH FRAME

SQUADRA



SQUADRA FLAT AND CONCAVE

Ductile iron

Secured by patented ductile iron spring-lock mechanism

EN 124

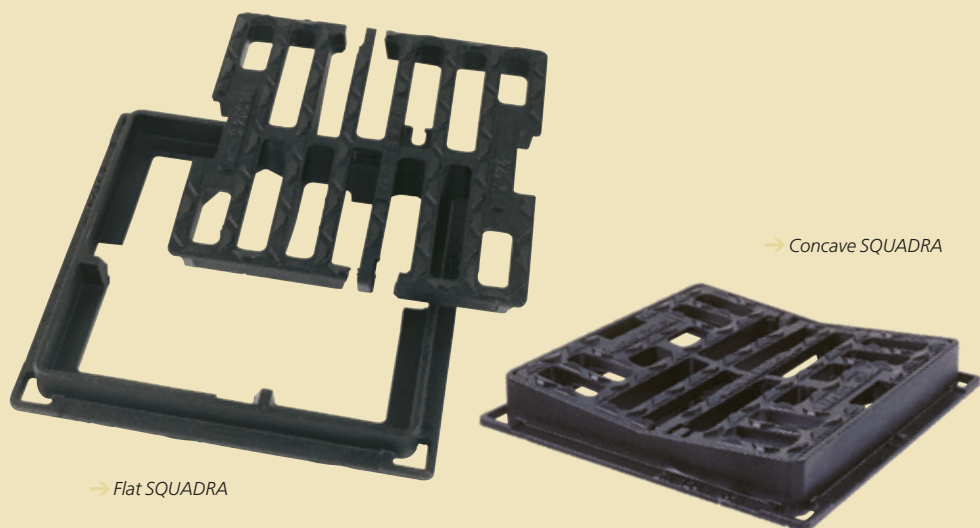

→ Flat SQUADRA

→ Concave SQUADRA

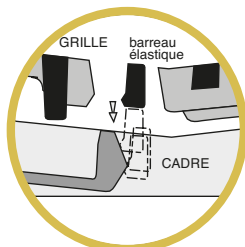

Successfully developed with AUTOLINEA gratings and the REXEL manhole cover, the ductile iron spring locking mechanism equips SQUADRA gratings. Locking of the gratings and a newly designed frame provide maximum stability and more precise installation on the gully pot.

STABILITY +++++

SQUADRA gratings incorporate a feature considered by users to be increasingly important: stability.

The «T» frame ensures optimum seating of the grating, and better assembly fit on the concrete gully pot.

INSTALLATION AND OPERATION +++++

- flat soled frame for practical and effective embedment
- compatible with prefabricated concrete manholes
- easy to open by system service teams using a crowbar or pickaxe as lever
- easy to close automatically : place the grating into its frame, exert pressure on the grating with foot or tool to lock it safely»

SAFETY +++++

- Flat SQUADRA gratings can be rotated 90° : the click-in system operates whatever the position of the grating in its frame. This feature means the bars can be placed perpendicular to the flow of traffic, irrespective of the way in which the frame has been sealed into place.
- Concave SQUADRA gratings also provide maximum safety with bi-directional bars ensuring safety for cyclists and pedestrians.

ABSORPTION +++++

- The bars have been specially developed to optimize absorption. In particular, the presence of a range of directional facets facilitates the washing away of leaves, and also breaks up the water sheet.
- Flat SQUADRA: rotate the grating in the frame to optimize absorption.
- Concave SQUADRA: dual bar orientation for maximum performance.

MASS		DIMENSIONS			WATERWAY AREA	REFERENCE
total	grating	frame	clear opening	depth	dm ²	
15.3	10.0	350	250	39	2.7	ECSQ35PF
18.5	12.0	410	300	39	5.2	ECSQ40PF
26.0	17.5	510	400	39	9.8	ECSQ50PF
36.6	25.6	620	500	39	15.1	ECSQ60PF
59.5	59.5	720	600	39	20.6	ECSQ70PF
71.5	71.5	820	700	39	28.5	ECSQ80PF

MASS		DIMENSIONS			WATERWAY AREA	REFERENCE
total	grating	frame	clear opening	depth	dm ²	
32.7	17.5	510	350	100	9.8	ECSQ50LF

MUDPAN FOR SQUADRA 500 FLAT GRATING WITH HIGH FRAME

7.0	-	385	325	600	-	E4
-----	---	-----	-----	-----	---	----

□ for paved areas and pavements, can be fitted with mudpan

MASS		DIMENSIONS			WATERWAY AREA	REFERENCE
total	grating	frame	clear opening	depth	dm ²	
14.9	9.6	350	250	39	3.0	ECSQ35PFX11
19.0	12.0	410	300	39	3.9	ECSQ40PFX11
36.2	21.0	510	400	100	7.8	ECSQ50LFX11
29.5	21.0	510	400	39	7.8	ECSQ50PFX11
40.0	29.0	620	500	39	12.8	ECSQ60PFX11
62.1	48.9	720	600	39	17.6	ECSQ70PFX11
79.0	64.1	820	700	39	24.7	ECSQ80PFX11

MASS		DIMENSIONS			WATERWAY AREA	REFERENCE
total	grating	frame	clear opening	depth	dm ²	
20.6	13.2	410	300	58/40	5	ECSQ40CF
30.4	19.5	510	400	63/40	9.8	ECSQ50CF
41.5	29.0	620	500	68/40	14.8	ECSQ60CF
61.2	45.5	720	600	73/40	20.7	ECSQ70CF
78.1	60.0	820	700	78/40	27.4	ECSQ80CF

MASS		DIMENSIONS			WATERWAY AREA	REFERENCE
total	grating	frame	clear opening	depth	dm ²	
20.0	12.5	410	300	58/40	4.8	ECSQ40CFX11
31.8	20.9	510	400	63/40	7.0	ECSQ50CFX11
44.1	31.5	620	500	68/40	12.8	ECSQ60CFX11
63.6	48.0	720	600	73/40	18.4	ECSQ70CFX11
81.5	63.2	820	700	78/40	26.4	ECSQ80CFX11

SQUADRA FLAT GRATING WITH FRAME C250



SQUADRA 500 FLAT GRATING WITH HIGH FRAME C250

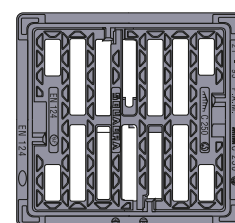

SQUADRA 500 FLAT GRATING «PMR» ACCESS FOR DISABLED PEOPLE C250



SQUADRA CONCAVE WITH FLAT FRAME C250

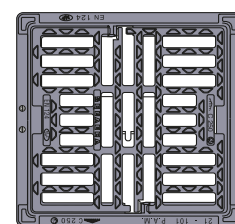

SQUADRA CONCAVE «PMR» WITH FLAT FRAME FOR DISABLED PEOPLE C250



SQUARE GRATINGS FOR KERSIDES

SQUARE GRATINGS



GRATINGS WITH HIGH FRAME

Ductile iron

Surrounding bedding flange

EN 124

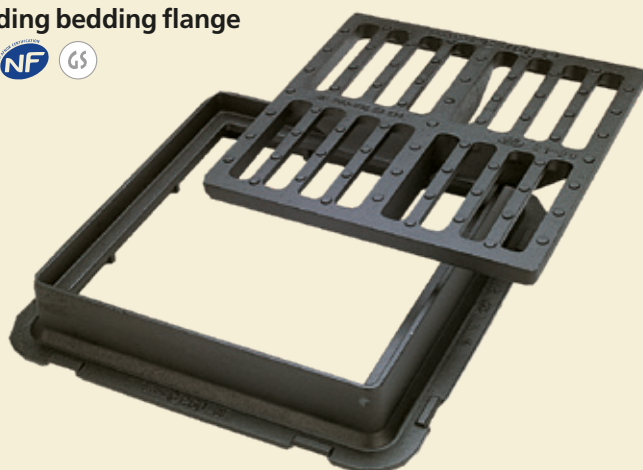

The ITALIA, LAZIO and MILANO gratings have a raised frame and a surrounding flange which reinforce the strength of their bedding and provide greater safety under traffic load. The absence of ribs on the outer face of the frame facilitates the installation of the gratings on paved roads or areas.

**FLAT GRATING
ITALIA
C250**



BASE SIZE mm	MASS		DIMENSIONS			WATERWAY AREA dm ²	REFERENCE
	total	grating	frame	clear opening	depth		
400x400	27.3	13.7	500	360	80	7.7	ECIT36PF

**FLAT GRATING
LAZIO
C250**



BASE SIZE mm	MASS		DIMENSIONS			WATERWAY AREA dm ²	REFERENCE
	total	grating	frame	clear opening	depth		
500x500	38.5	23.5	570	450	70	11.8	ECLZ57CF

**FLAT GRATING
MILANO
C250**



BASE SIZE mm	MASS		DIMENSIONS			WATERWAY AREA dm ²	REFERENCE
	total	grating	frame	clear opening	depth		
500x500	31.8	22	560x500	440	45	11.8	ECGP50PF



SQUARE GRATINGS WITH FRAME

Ductile iron
Bedding lugs

EN 124  

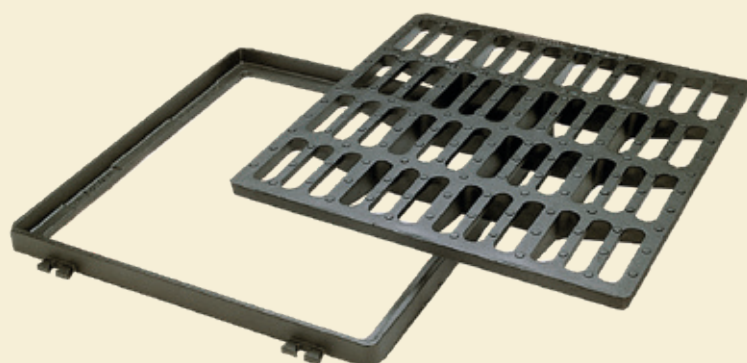

Flat and concave square gratings provide a simple solution for the top of gully pots located in traffic-free areas.

BASE SIZE mm	MASS		DIMENSIONS			WATERWAY AREA dm ²	REFERENCE
	total	grating	frame	clear opening	depth		
200x200	5.8	3.4	218	165	27	1.7	ECGP20PF
250x250	8.3	5.0	269	215	27	2.4	ECGP25PF
300x300	12.4	7.4	319	255	27	4.2	ECGP30PF
400x400	21.3	13.7	422	351	27	7.7	ECGP40PF
500x500	29.4	20.1	543	450	27	11.8	ECGP56PF
600x600	47.6	35.6	624	549	27	16.8	ECGP60PF
700x700	71.6	55.5	725	647	27	20.2	ECGP70PF
800x800	91.3	70.9	827	744	29	27.6	ECGP80PF

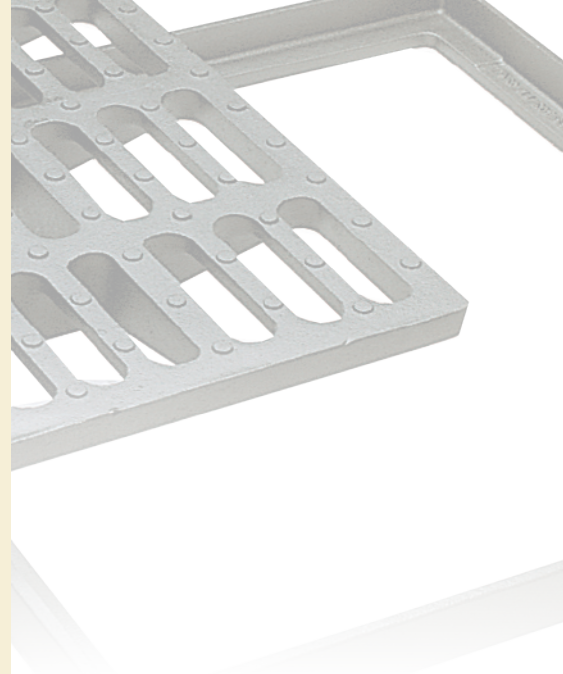

SQUARE FLAT GRATINGS WITH FRAME C250



BASE SIZE mm	MASS		DIMENSIONS			WATERWAY AREA dm ²	REFERENCE
	total	grating	frame	clear opening	depth		
400x400	21.1	13.3	422	351	40	7.7	ECGC40CF
500x500	31.1	21.0	523	450	40	11.8	ECGC50CF
600x600	49.4	37.0	624	549	40	16.8	ECGP60CF
700x700	74.5	58.0	725	647	42.5	20.2	ECGP70CF
800x800	96.5	75.0	827	744	42.5	27.6	ECGP80CF

SQUARE CONCAVE GRATINGS WITH CONCAVE FRAME C250



RECTANGULAR GRATINGS FOR

AT

C250

GRATING AT - FLAT GRATING WITH FRAME

Ductile iron

EN 124  

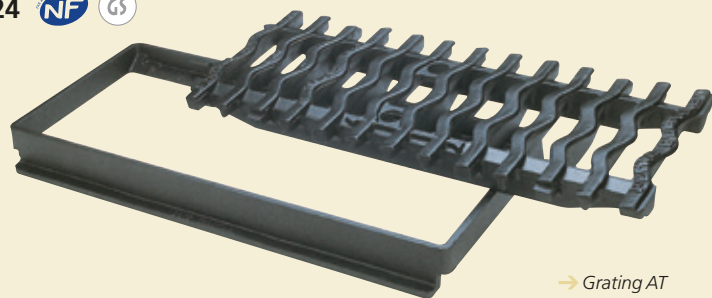

→ Grating AT

TYPE	BASE SIZE	MASS		DIMENSIONS	WATERWAY AREA	REFERENCE		
		total	grating					
AT	750x300	40	25	776	746	41	8.7	ECCL30DF
Flat	750x300	41	20	776	746	41	7.5	ECML30ZF

Flat rectangular gratings with frames are usually installed at the kerbside, alone or in addition to a cover plate or a gully.

→ Flat grating

GRATING AT C250

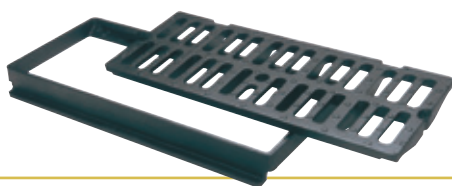

SOLE

C250

SOLE

Ductile iron

400 kN test load

Hingeing on lengthwise

Handling box

Anti-theft grating

Reinforced frame

EN 124  

BASE SIZE	MASS		DIMENSIONS	WATERWAY AREA	REFERENCE		
	total	grating					
600x350	37.5	22.0	725x420	600x350	77	9.22	ECS063EF

Easy to open, the SOLE grating is designed to allow quick access to sewer systems. Its raised frame is fitted with a three sides bedding flange, allowing solid and durable bedding at the kerbside, opposite a gully for example. The grating is anti-theft once it has been bedded.

SOLE GRATING C250

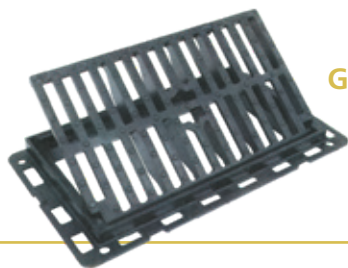

ESKOA

D400

ESKOA

Ductile iron

EN 124

TYPE	FRAME	MASS		DIMENSIONS		REFERENCE
		total	cover	clear opening	frame depth	
D400	square	43.0	28.0	810x290	80	EDEK80PK

Automatic locking system with elastic ductile iron bar with handling box located in front of the grate for ergonomic opening with usual tools and integrated anti-theft system.

ESKOA D400





SELECTA KERB GRATINGS

Ductile iron

Articulated grating

Locking feature due to spring-lock device

EN 124

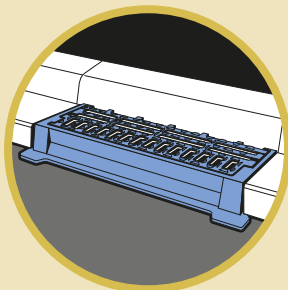
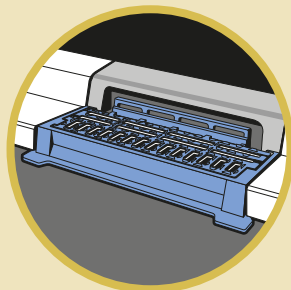
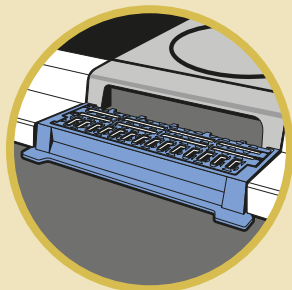

→ SELECTA kerb grating combined with gully plate

→ Selecta kerb grating combined with gully inlet

→ SELECTA grating installed alone

SELECTA kerb gratings are fully compatible with standard kerb dimensions as defined in French standard NF P 98-302.

They are easy to install and are impeccably finished.

→ Reinforced frame for complete stability and effective seating on concrete structures.

The SELECTA grating with T-profile raised selector bars is compatible with:

- T-profile cover plate, ref.: ECRV80TF,
- T-profile gully, ref.: ECAV80TF

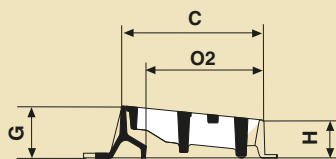

SELECTA

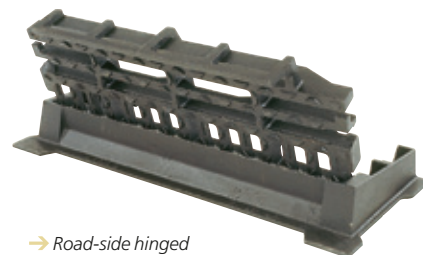

→ Road-side hinged

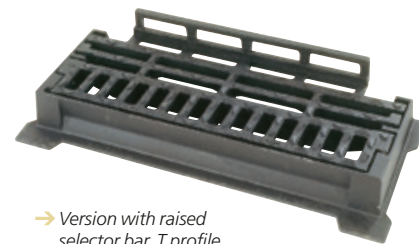

→ Version with raised selector bar, T profile

SELECTA KERB GRATINGS

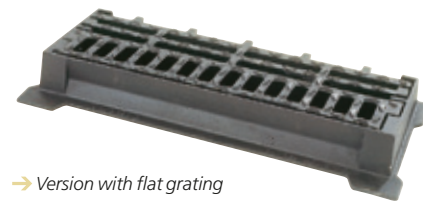

→ Version with flat grating

OVERALL DIMENSIONS	MASS	DIMENSIONS			WATERWAY AREA dm ²	REFERENCE
		overall HT	clear opening O	depth H/h		
Flat grating version						
800x320	33.8	800x320	650x200	90/68	7.6	ECSE80PF
With selector bar						
800x320	39.5	800x320	660x205	90/68	8.45	ECSE80UF

OVERALL DIMENSIONS	MASS	DIMENSIONS			WATERWAY AREA dm ²	REFERENCE
		overall HT	clear opening O	depth H/h		
Flat grating version with studs inlet support						
800x320	34.5	800x320	660x205	90/68	6.1	ECSE80PFX11
Flat grating version without studs inlet support						
800x320	34.5	800x320	650x200	65	6.1	ECSE80PFX31

SELECTA KERB GRATINGS "PMR" ACCESS FOR DISABLED PEOPLE





SELECTA



SELECTA

Ductile iron

EN 124



Cover and gratings by spring-bar locked

Adjustable to pavement and kerb levels

Selecta is available in 3 versions:

→ 1 SELECTA MAXI

- height adjustable
- A or T profile
- raised selector bar grating
- flat grating

→ 2 SELECTA 500

- A or T profile
- raised selector bar grating
- flat grating

→ 3 SELECTA MAXI 20-40

- for ultra-low kerbs
- fits for disabled people crossing kerbs
- height adjustable

→ Easy access & maintenance

- Spring-bar locked can be open independently for rodding, cleaning, sucking.

→ Screening of debris

- The presence of a raised bar prevents access into the gully for debris of too large a size and keeps certain solid objects carried by run-off water out of the sewer system.

→ Anti-obstruction

- The surfaces of the bars are equipped with facets that are oriented in such a way as to prevent leaves or litter from blocking the drain.

→ Adjustability

- Three bolts allow the height adjustment (up to 50 mm) of the cover frame with respect to the kerb.

→ Automatic locking

- Ductile iron spring bar integral with grate and cover.

→ Safety for pedestrians

- On the pavement side, the elimination of clearance on the hinge system and of any roughness on the surface of the cover ensure safety for pedestrians (high heels, walking sticks, crutches, etc.).

→ Drainage

- In the lower section of the gutter, the bars are arranged longitudinally in order to maximize water drainage. Simulations carried out on a test bench show increases of between 10 % and 15 % in absorption, in certain circumstances, compared with a traditional design consisting of a rectangular grating and a gully.

→ Safety for cyclists

- On the carriageway, the bars are perpendicular to the direction of the traffic in order to ensure safety for cyclists.

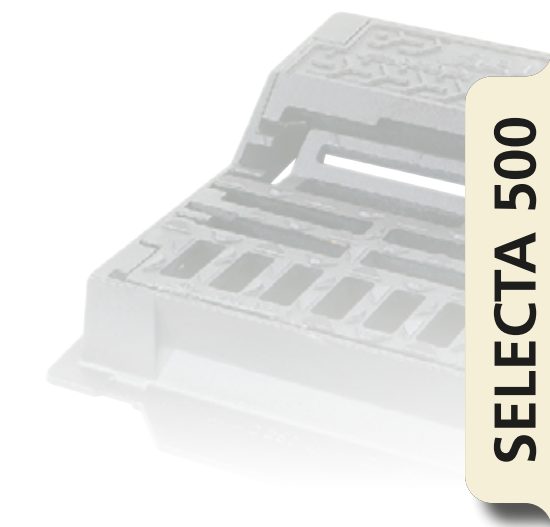

SELECTA 500

SELECTA 500

COMPACT & HIGH-CAPACITY NOT HEIGHT ADJUSTABLE

- SELECTA 500 drain gullies are installed on standardized gully pots (500 mm), and are designed for mixed roadway/pavement installation.
- Broad soled frame for effective seating on concrete structures. Dimensions compatible with gratings, gullies, bases, and concrete kerbing.
- Raised selector bar grating or flat grating (without selector bar).
- Cover and grating spring-bar locked and hinged.

→ 2 SELECTA 500, A-profile with raised selector bar grating



→ 2 SELECTA 500, T-profile with flat grating



SELECTA 500 COMPACT & HIGH-CAPACITY



→ 2 SELECTA 500, T-profile with raised selector bar grating

KERB PROFILE	MASS				DIMENSIONS			WATERWAY AREA dm ²	REFERENCE
	total	grating	cover	frame	overall	depth H/h	effective opening		
with raised selector bar grating									
T-profile	54.5	16.5	14.0	24.0	610x570	205/90	385	8.5	ECSE61TF
A-profile	50.5	16.5	13.0	21.0	610x570	125/90	385	7.6	ECSE61SF
with flat grating									
T-profile	53.0	15.0	14.0	24.0	610x570	205/90	385	9.8	ECSE61UF

SELECTA MAXI LEVEL ADJUSTMENT AND MAXIMUM CAPACITY

- SELECTA Maxi gullies are designed for mixed roadway/pavement installation.
- Cover and kerb leveled using 3 adjustment bolts integrated into the frame.
- Raised selector grating or flat grating.
- Cover and grating spring-bar locked and hinged



→ 1 SELECTA Maxi, A-profile with raised selector bar grating.



→ 1 SELECTA Maxi, T-profile with raised selector grating

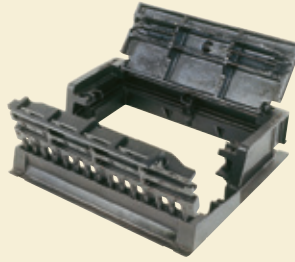

→ 1 SELECTA Maxi, A-profile with raised selector bar grating

KERB PROFILE	MASS			DIMENSIONS			WATERWAY AREA		REFERENCE	
	total	grating	Cover	frame	overall	depth H/h	effective opening	depth adjustment		dm ²
with raised selector bar grating										
T-profile	94	27	24	44	750x640	225/90	540x450	50	10.1 à 13	ECSE75UFX11
A-profile	83	25	22	39	750x640	155/90	540x450	20	9.4 à 10.7	ECSE75SFX11
with flat grating										
T-profile	89	21	24	44	750x640	225/90	540x450	50	11.6 à 14.5	ECSE75UFX16

SELECTA MAXI

SELECTA MAXI LEVEL ADJUSTMENT & MAXIMUM CAPACITY

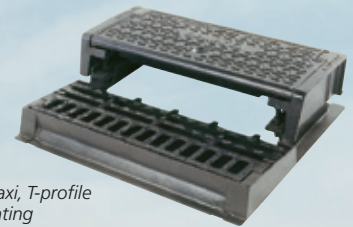

→ 1 SELECTA Maxi, T-profile with flat grating

SELECTA MAXI 20-40 " ULTRA-LOW KERBS " FOR DISABLED CIRCULATION C250

Debris-selecting gully for use on places, streets & areas where vertical kerb faces are only 20 to 40 mm high, facilitating the crossing of wheel chairs and mobility trolleys

Selecta Maxi 20-40 comprises 2 independent components:

- **A** road-side unit (grating + frame), to be bedded flush with road level
- **B** kerb-side unit (cover + frame), to be bedded flush with kberb upper surface
- Wide frames bearing surfaces for perfect bedding on mortar
- Units **A** & **B** are not linked but installed face to face, allowing easy & precise setting to the exact finish levels



total	MASS		DIMENSIONS			WATERWAY AREA		REFERENCE
	grating + frame	cover	overall	depth H/h	effective opening	dm ²		
92.0	37.0	55.0	800x675	155/90	385	20 mm visible face : 6	ECSE75UFX13	
						40 mm visible face : 7		

SELECTA MAXI 20-40



SELECTA MAXI PMR 20-40 ULTRA-LOW KERBS



GULLY UNITS

C250

GULLY COVER PLATES AND INLETS

Ductile iron

Classe C 250 (frame) Classe B 125 (cover)

EN 124  

The cover plates are designed to be fitted on large sized gully pots under pavements (kerb or carriageway combination).

Inlets are simple versions of cover plates without cover

GULLY COVER PLATES C250

KERB PROFILE	MASS		DIMENSIONS			WATERWAY AREA dm ²	REFERENCE
	total	cover	overall	clear opening	depth		
Profile A	69.3	24.3	800x830	610	120	4.3	ECRV80AF
Profile T	72.3	24.3	800x830	610	200	6.0	ECRV80TF



GULLY INLETS C250

KERB PROFILE	MASS kg	DIMENSIONS		WATERWAY AREA dm ²	REFERENCE
		overall	depth		
Profile A	21.0	800x225	120	4.2	ECAV80AF
Profile T	24.5	800x225	200	6.0	ECAV80TF

GULLY GRATING

C250

Ductile iron

EN 124  

These inlet gratings are fitted on small gully pots (500 mm) of a mixed road/pavement type installation. The grating's profile is specially designed to prevent obstruction by leaves or other debris whilst allowing the maximum drainage.

GULLY GRATINGS C250

KERB PROFILE	MASS		DIMENSIONS			WATERWAY AREA dm ²	REFERENCE
	total	cover	overall	clear opening	depth		
Profile A	55.6	31.0	605x502	405	176	9.0	ECGA60AF
Profile T	61.6	32.0	605x502	405	233	10.1	ECGA60TF



OPTEA

C250

OPTEA FLAT SQUARE GRATING

Ductile iron

EN 124

OPTEA FLAT GRATING C250

	MASS		DIMENSIONS			WATERWAY AREA dm ²	REFERENCE
	total	grating	frame	clear opening	depth		
	8.1	4.8	300	200	36	2.3	ECOP30PK
	13.8	9.7	400	303	36	5.2	ECOP40PK
	19.2	14.0	500	400	36	9.5	ECOP50PK
	29.2	22.7	600	500	36	15.3	ECOP60PK





COMMUNAL GRATINGS

Ductile iron

EN 124

Sloped reinforced frame

Available with or without centring lug

Seating flange on 3 sides

The COMMUNAL grating is equipped with a sloped frame which automatically ensures a crossways slope. The bedding flange on three sides facilitates fitting along the kerb and ensures optimum stability.

TYPE	BASE SIZE	MASS		DIMENSIONS			WATERWAY AREA dm ²	REFERENCE
		total	grating	frame	clear opening	depth		
With lugs	500x500	53	23.5	670x600	405	119	11.8	ECGP67PFX20
Without lugs	500x500	51.5	23.5	670x600	405	119	11.8	ECGP67PFX19

□ NB : In case of intense traffic, we recommend the installation of the range DEDRA 400. See page 45.

COMMUNAL



COMMUNAL FLAT GRATING
C250



CHANNEL GRATINGS

Ductile iron

EN 124

TYPE	MASS	DIMENSIONS			WATERWAY AREA dm ²	REFERENCE
		length	width	depth		
GRATINGS 500x124						
thickness = 20 mm						
C 250	3.5	500	124	20	3.0	EECL12PX
D 400	4.5	500	124	28.5	2.6	EDCL51PX
E 600	4.5	500	124	28.5	2.6	EECL12PX
Connecting device: 168044						
FRAME FOR GRATINGS 500x124						
	3	500	164	50	-	EECL120

CHANNEL GRATING

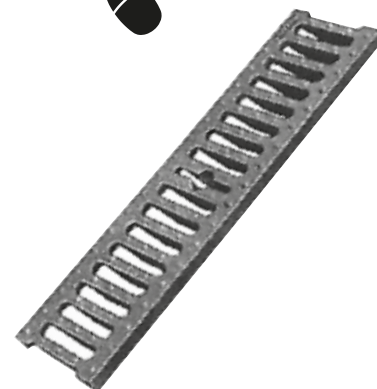
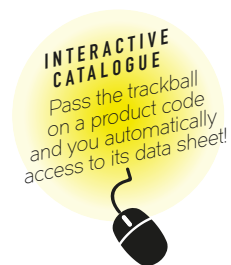

CHANNEL GRATING

AUTOMATIC ODOUR-TIGHT INLETS "PAG"

This device, fitted in shafts topped with all types of gratings, acts as an automatic odour-trap and prevents the escape of smells. For bottom of shaft / chambers with inside dimensions of 500 and 700 mm.

TYPE	MASS	DIMENSIONS			WATERWAY AREA dm ²	REFERENCE
		overall	clear opening	depth		
PAG n°2	44.0	540x525	456	310	4.0	ECPG452X
PAG n°3	80.0	738x738	590	460	4.0	ECPG593X

PAG



ODOUR-TIGHT INLETS PAG

LONGITUDINAL CHANNEL GRATING

AUTOLINEA

D400

AUTOLINEA

Ductile iron

Automatic ductile iron spring bar (patented system)

EN 124  

C250

A brand new generation of channel gratings, AUTOLINEA gratings are linked together by a ductile iron spring bar. They are usually installed on cast iron T section frames or steel angle fittings which protect the concrete channel and maintain the support level.

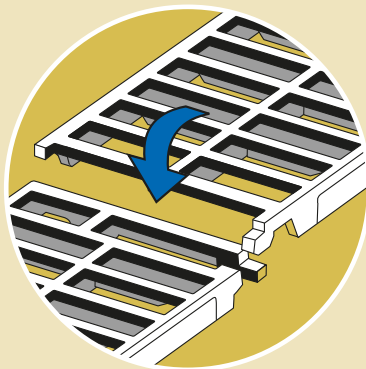

Functional diagrams
of AUTOLINEA C 250
locking/unlocking

1) SIMPLE !

Easy to install. Gratings are simply snapped into place through a ductile spring lock.

With AUTOLINEA, no accessories are needed.

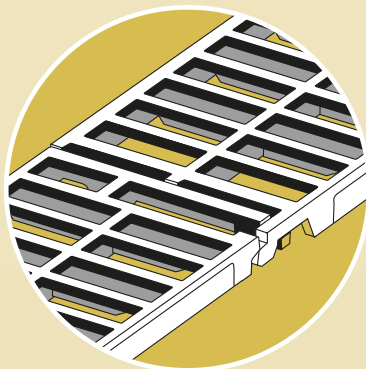

2) SAFE !

AUTOLINEA provides safety in service :

- no danger of accidental displacement,
- limit vandalism,
- anti-dilatation effects.

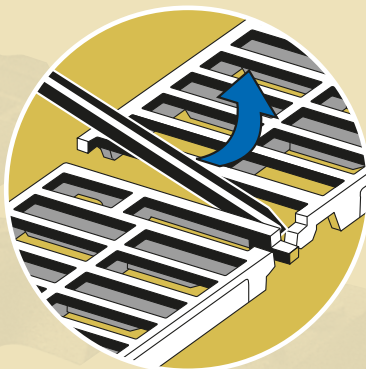

3) QUICK !

Removal by professionals is instantaneous, using a crowbar as a lever.

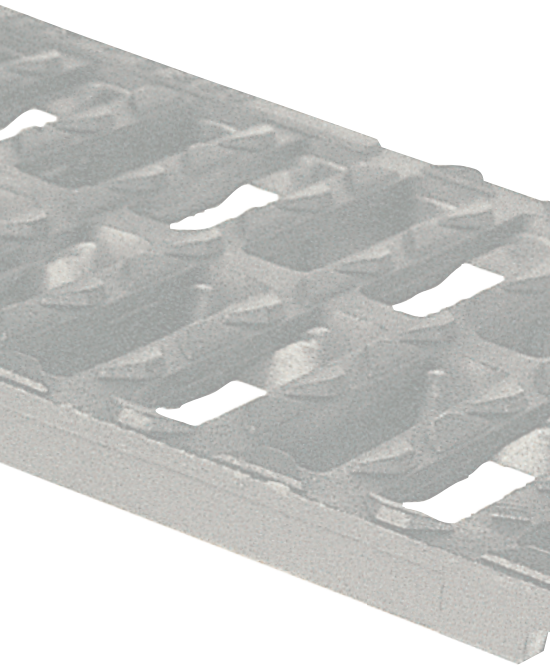

D400

AUTOLINEA D 400

FIELD OF APPLICATION:

Channels located at the side of motorways and roads carrying intense traffic, excluding singular points which may be subject to crosswise traffic, such as : interchanges, lay-bys, and telephone call stations, breaks in central reservations and crossroads, in which case the TRANSLINEA grating designed for crossing carriageway are required. (See page 58).

BASE SIZE	MASS	DIMENSIONS			WATERWAY AREA dm ²	REFERENCE
		clear opening*	depth	thickness		
750x300	24	250	60	35	11	EDAL30PF
750x400	33	350	85	35	15	EDAL40PF
750x500	43	450	85	35	20	EDAL50PF

* when using cast iron T section frame

C250

AUTOLINEA C 250

FIELD OF APPLICATION:

Street channels along pavements, excluding singular points which may be subject to crosswise traffic in the field of class C 250 and for which the linked MECALINEA grating is required. (See page 59).

BASE SIZE	MASS	DIMENSIONS			WATERWAY AREA dm ²	REFERENCE
		clear opening*	depth	thickness		
750x200	11.8	150	35	30	7.6	ECAL20PF
750x250	18.1	200	50	30	9.0	ECAL25PF
750x300	21.8	250	56	30	11.2	ECAL30PF
750x400	24.8	350	75	30	15.0	ECAL40PF
750x500	36.3	450	80	30	20.4	ECAL50PF
750x600	49.5	550	85	30	24.6	ECAL60PF
750x700	59.8	650	85	30	28.4	ECAL70PF

* when using cast iron T section frame

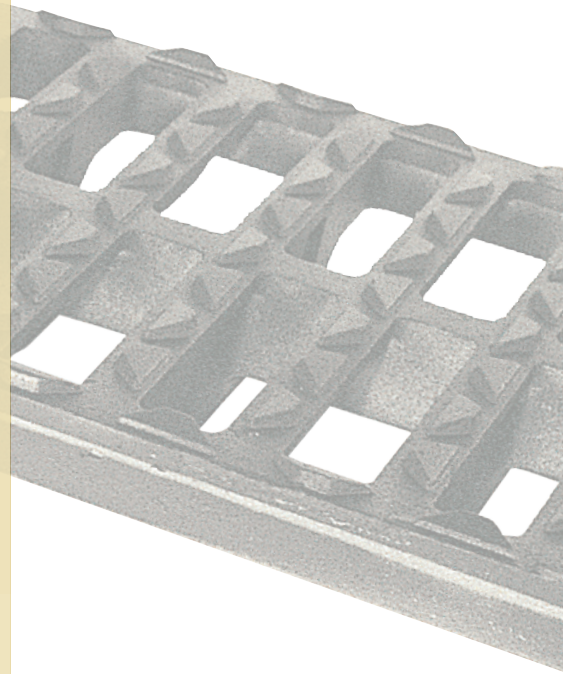

AUTOLINEA D 400

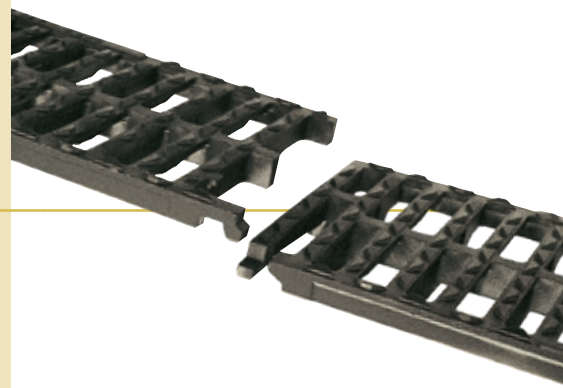

AUTOLINEA C 250



GRATINGS FOR LONGITUDINAL

TRANSLINEA



TRANSLINEA

Ductile iron
Mechanical chaining

Securing to channel

EN 124



TRANSLINEA gratings are used, above all, for crossing carriageways.

They must be installed with the chaining devices joining the gratings together and the end pieces securing the gratings to the channel. This complete, modular system ensures optimum safety under traffic load. Please see the fitting instructions.

TRANSLINEA E 600

FIELD OF APPLICATION:

All areas involving high axle loads such as: aircraft and port areas, plants, in particular.

TRANSLINEA E 600

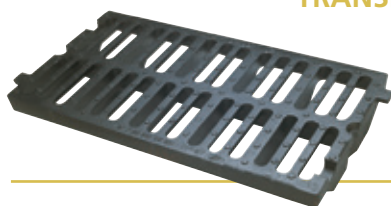

CLASS	BASE SIZE	MASS	DIMENSIONS			WATERWAY AREA dm ²	REFERENCE
			clear opening*	depth	area		
E 600	750 x 400	43.1	350	85	35	12.1	EETL40PF

* when using cast iron T section frame

TRANSLINEA D 400

FIELD OF APPLICATION:

All carriageway crossing points, roads carrying intense traffic and other singular points such as: interchanges, lay-bys and telephone call stations, breaks in central reservation and crossroads.

TRANSLINEA D 400



CLASS	BASE SIZE	MASS	DIMENSIONS			WATERWAY AREA dm ²	REFERENCE
			clear opening*	depth	area		
D 400	750x400	43.1	350	85	35	12.1	EDTL40PF

* when using cast iron T section frame

CAST IRON SECTION FRAME FOR AUTOLINEA D 400 AND TRANSLINEA E 600 / D 400



TYPE	MASS kg	DIMENSIONS		REFERENCE
		length	depth	
length 750 mm	10	350	85	E7

- Note : To ensure that channel gratings in classes D 400 and E 600 provide optimum strength and stability when subjected to traffic stresses, approval is granted to complete units comprising the grating, its cast iron T section frame and, where applicable cast iron end pieces.
- If other types of T section frame or angle fitting are used, i.e. steel in particular, their dimensioning and their anchoring in the masonry must be ensured by the specifier, taking into account the stresses due to traffic.

T SECTION FRAME ACCESSORIES SPECIFIC TO TRANSLINEA E 600 / D 400



TYPE	MASS	DIMENSIONS		REFERENCE
		length	depth	
T section frame piece 800 mm long	10.6	800	100	E8
→ A Cast iron end piece	4.4	400	85	E10
→ b Chaining device	0.5	-	-	E9



MECALINEA

Ductile iron

Chaining of gratings

EN 124  

MECALINEA gratings are traditional gratings with mechanical chaining that are installed on cast iron T section frame or steel angle fittings.

FIELD OF APPLICATION:

As per class C 250 : street channels along the side of pavements and, in particular, singular points which may be subject to crosswise traffic and where chaining is necessary.

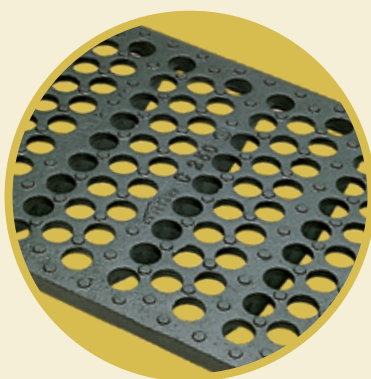

MECALINEA



MECALINEA GRATING WITH BARS C250

BASE SIZE	MASS	DIMENSIONS			WATERWAY AREA dm ²	REFERENCE
		clear opening*	depth	thickness		
GRATINGS WITH BARS						
750x200	16.1	150	40	27	5.46	ECML20PF
750x250	18.0	200	45	27	6.06	ECML25PF
750x300	22.5	250	50	27	8.04	ECML30PF
750x350	30.0	300	60	27	10.18	ECML35PF
750x400	30.0	350	60	27	12.24	ECML40PF
750x500	42.0	450	55	27	14.90	ECML50PF
750x600	50.0	550	60	27	17.15	ECML60PF
750x700	62.3	550	65	27	20.13	ECML70PF

* when using cast iron T section frame

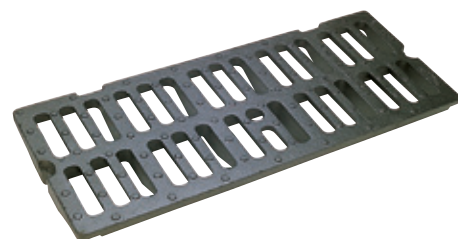

MECALINEA GRATING WITH ROUND HOLES C250

BASE SIZE	MASS	DIMENSIONS			WATERWAY AREA dm ²	REFERENCE
		clear opening*	depth	thickness		
GRATINGS WITH ROUND HOLES						
750x400	32.0	350	60	27	10.88	ECML40RF
750x600	50.0	550	60	27	17.10	ECML60RF

* when using cast iron T section frame

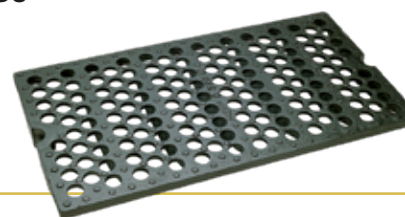

MECALINEA ACCESSORIES

TYPE	MASS	DIMENSIONS		REFERENCE
		length	depth	
Frame pieces	4.0	750	27	E5
Connecting piece	0.5	-	75	E6



PAVA

EXTENDABLE SURFACE BOXES

Saint-Gobain PAM proposes four separate product ranges which cater to different requirements. Specific catalogue available on request.

PAVA surface boxes feature built-in extension capabilities. The lower base of the body features screw nut type threads and is designed to allow the unit to be raised during road resurfacing operations by simply "unscrewing" the assembly. The design includes:

- A self-locking system which prevents the cover from being removed by street cleaning equipment or by vandalism.
- A wide base reduces the risk of subsidence under traffic loads: stability and silence of the cover on its seat.
- Side bonding ribs at the base of the body to prevent its rotation during height adjustment operations.

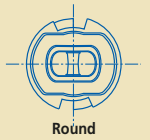
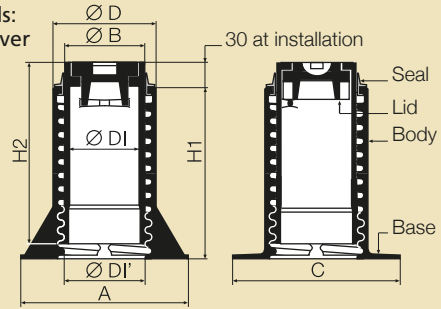

Round

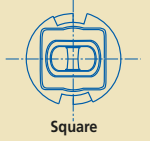

Square

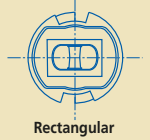

Rectangular



Hexagonal

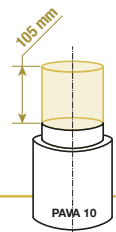

PAVA 10

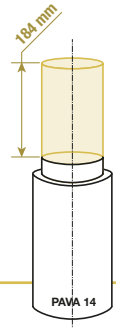

PAVA 14

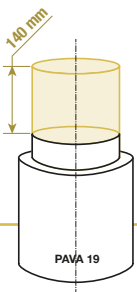

PAVA 19



H1	H2	Ø DI	A	C	Ø DI'	Ø B	Ø D	MASS	EXTEN- DIBILITY	REF.
145	170	102	240	220	137	114	147	8.4	105	F1PVAC

□ Other lid versions and options (shape and chain) are available, please contact us for details.

H1	H2	Ø DI	A	C	Ø DI'	Ø B	Ø D	MASS	EXTEN- DIBILITY	REF.
250	250	102	240	220	137	114	147	12.8	184	F2PVAC

□ Other lid versions and options (shape and chain) are available, please contact us for details.

H1	H2	Ø DI	A	C	Ø DI'	Ø B	Ø D	MASS	EXTEN- DIBILITY	REF.
192	222	120	300	282	148	162	216	21.40	140	F3PVAC

□ Other lid versions and options (shape and chain) are available, please contact us for details.



Designed to simplify the extension operation, the covers of the PAVA 10 and 14 can be turned over and used as a tool to limit the operating force. Equipped with two studs forming an operating nut, the inside face of the lid can be used to adjust the extension height using a plain 30 mm wrench or with a Tee wrench used for valve operation. The PAVA 19 requires the use of a specific operating cover.

Reference: F3PVRC-T

TOTALE SURFACE BOXES RANGE

Two versions are available: "Sidewalks and streets". The base of the "street" version offers a wide bearing surface for enhanced stability under traffic loads.

Surface boxes with "water" badging have a hook-opener type lid with no through hole, chainless*

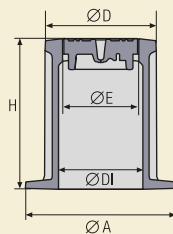

→ Sidewalk

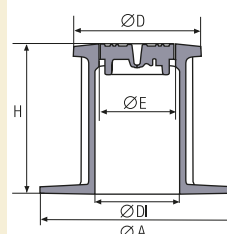

→ Street

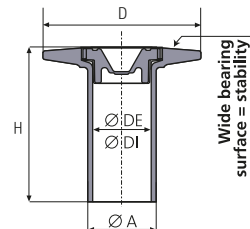

→ Extension

TYPE	H	Ø A	Ø DI	Ø E	Ø D	MASS	REFERENCE		
							round	square	hexagonal
Sidewalk	160	150	102	77	120	3.5	FTTOAB	FTTOBB	FTTODB
Street	160	210	102	77	140	4.8	FRTOAB	FRTOBB	FRTODB
Extension	166	74	63	87	170	3.6	FRT063U	FRT063V	FRT063W



□ Other lid versions and options (shape and chain) are available, please contact us for details.

SURFACE BOX TOTALE



TOTALE MAXI SURFACE BOXES

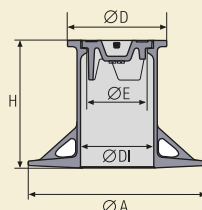

H	Ø A	Ø DI	Ø E	Ø D	MASS	REFERENCE		
						round	square	hexagonal
180	250x220	102	84	140	6.4	FTTOAB	FRT063U	FRTOAB



SURFACE BOX TOTALE MAXI



HEIGHT ADJUSTABLE EXTENSION FOR SURFACE BOXES

Height adjustable surface boxes (used as Extension for TOTAL MAXI)

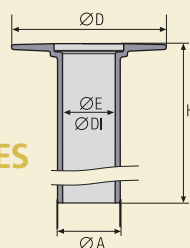

H	Ø A	Ø DI	Ø E	Ø D	MASS	REFERENCE		
						round	square	hexagonal
370	81	68	68	200	7	FRRHACT	FRRHBCT	FRRHDCT



SURFACE BOX HEIGHT ADJUSTABLE

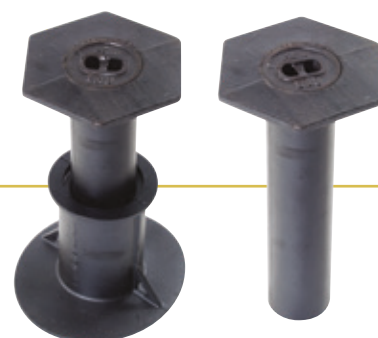

SURFACE BOXES ACCESSORIES

TYPE	REFERENCE
Hammer for surface box	162 098

HOW TO CONTACT SAINT-GOBAIN PAM?

AUSTRIA

Saint-Gobain Rigips AUSTRIA GesmbH
Vertriebsbüro PAM
Archenweg 52
6020 Innsbruck
Tel: + 43 512 34 17 17 -0

BELGIUM

Saint-Gobain PAM BELGIUM
Raathovenstraat, n°2
3400 – LANDEN
Tel: + 32 11 88 01 00

FINLAND

Saint-Gobain PAM FINLAND
Strömberginkuja 2
00380 HELSINKI
Tel: +358 207 424 600

GREECE

Saint-Gobain HELLAS
5 KLEISOURAS STR,
14452 METAMORGOSI ,ATHENS GREECE
Tel: +30 210 2831804

NORWAY

Saint-Gobain BYGGEVARER
Nils Hansens vei 13,
0667 OSLO
Tel: + 47 23 17 58 60

THE NETHERLANDS

Saint-Gobain Pipe Systems
Markerkant 10-17
1316 AB ALMERE
Tel: + 31 36 53 333 44

POLAND

Saint-Gobain Construction Products POLSKA SP Z O.O.
Ul. Cybernetyki 9
PL - 02-677 WARSZAWA
Tel: + 48 22 751 41 72

PORTUGAL

Saint-Gobain PAM PORTUGAL, S.A.
Rua das Marinhas do Tejo , n° 15
2690-361 SANTA IRIA DE AZÓIA
Tel: + 351 218 925 000

CZECH REPUBLIC

Saint-Gobain PAM CZ
Budova DOCK II,
Smr kova ulice,
Praha 8 – Libe
Tel: + 420 311 712 611

ROMANIA

Saint-Gobain Construction Products Romania S.r.l.
SGCPRo SRL
Soseaua Pipera nr.43, Cladirea Floreasca Park,
corpul A, etajul 3, birourile 25-41, cod 014254,
sector 2, Bucuresti, Romania
Tel: + 40 21 207 57 29

SLOVAKIA

Saint-Gobain Construction Products, s.r.o.
Dlha 1780/6
90031 Stupava
Tel: +421 (0) 2 654 569 61

**Enquiries from other EU and overseas countries:
please consult Saint-Gobain PAM:
contact-export-covers@saint-gobain.com**



Saint-Gobain PAM • Head office

21, avenue Camille Cavallier
54705 Pont-à-Mousson Cedex • FRANCE
Phone : +33 (0) 383 807 350
www.pam-cast-iron.com