

VALVES & FITTINGS

Drinking Water

Valves
Couplings
Flanged fittings
Fittings for plastic OD



A SAFE PATH FOR WATER



VALVES & FITTINGS

EXPERIENCE

Thanks to more than a century of worldwide experience in water network casting & manufacturing Saint-Gobain PAM Canalisation has a comprehensive potable water and sewage system product range to ensure complete and reliable solutions, tailored to every requirement.

Originating from its R&D centre, Saint-Gobain PAM Canalisation's products are continuously in the lead with research based innovation making them the choice for all professionals concerned with quality, sustainability, simplicity of installation and maintenance of their networks.

Part of the Saint-Gobain group, with over 150 years of experience and industrial societies, commercial and technical assistance anywhere around the world, France, Italy, Germany, UK, Spain, Brazil manufacturing valves and couplings for different water market projects. Its skilled, dedicated personnel and its environment protection measures for all production sites have enabled it to obtain ISO 9001-2015 and ISO 14001-2015 quality certifications as well as meeting National quality assurance standards in many countries.

Thanks to its extensive sales and distribution network, throughout the world, Saint-Gobain PAM Canalisation guarantees the best service to all its clients.

Comprehensive pipe systems range is the result of more than 100 years of experience during which we have applied innovations in design and construction techniques as well as new materials and coatings. We have created a high performance valves and fittings guaranteeing long lasting operation, simple installation and maintenance, together with complete compliance with sanitary standards.

Saint-Gobain PAM Canalisation provides technical support at all stages of the project through its teams and technical sales agencies worldwide. The company's website: www.pamline.com is a source of information and help 24/7.

Saint-Gobain PAM Canalisation meets the requirements of its clients with complete and perfectly adapted solutions.

A complete range of products for water networks

Valves

Isolating valves	
	Gate valves P.3
	Butterfly valves P.10
Pipeline protection	
	Air valves P.17
	Control valves P.19
	Check valves, strainers P.22
	Tank equipment P.23
Fire protection	
	Pillar-fire hydrants P.24
	Underground fire hydrants P.28
Housing connexion	
	Ferrule cock P.30

Couplings & flange adaptors

	Flange adaptors P.34
	Couplings P.37
	Repair clamps P.40
	Dismantling joints P.43
	Tapping collars P.44

Flanged fittings

	Rotatable flanged fittings P.52
	Fixed flanged fittings P.60

Fittings for PVC PE and BLUTOP® pipes

	IZIFIT® Range P.78
	BLUTOP® Range P.83

PAM : all essential equipment for water networks

DESIGNER AND MANUFACTURER...

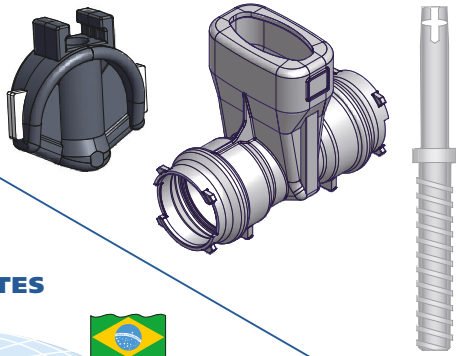

QUALITY EXCELLENCE

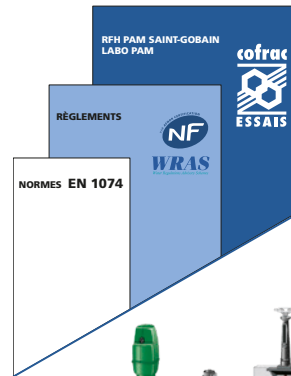

WORLDWIDE PRODUCTION SITES



ITAUNA
BRAZIL

LAVIS
ITALY

TOUL
FRANCE



COMPLETE AND...



... SUSTAINABLE SOLUTIONS

CLOSE TO OUR CUSTOMERS



VALVES

Table of contents

■ Isolating valves / Gate Valves	3	Triple function PURGEX 60	18
EURO 20 NEW TYPE 23 Serie S14	4	■ Control valves.....	19
EURO 20 NEW TYPE 21 Serie S15	4	Automatic control valves series E2001	19
EURO 20 TYPE 21.....	4	Direct action DRVD	20
EURO 20 TYPE 23.....	5	Needle valve E508.....	20
EURO 20 TYPE 23 Motorised.....	5	Safety butterfly valve.....	21
EURO 20 TYPE 21 PN 25	5	Pressure relief valve	21
EURO 20 TYPE BLUTOP	6	■ Check valves& strainers	22
EURO 20 TYPE 25.....	6	Swing check valve	22
EURO 20 TYPE 27.....	6	Strainer Y type	22
EURO 20 FM APPROVED	7	Strainer T type.....	22
ACCESSORIES FOR EURO 20 Ranges	8	■ Tank equipment	23
■ Butterfly Valves - Double offset	10	Foot check valve with strainer.....	23
EUROSTOP - Manual standard.....	10	Float valve	23
EUROSTOP ES manual.....	10	Tank access cover	23
EUROTOP Motorisable.....	11	■ Fire Hydrants	24
EUROSTOP LM.....	11	ELANCIO	25
EUROSTOP Motorised.....	12	ATLAS +.....	26
EUROSTOP Buried Service.....	12	C9+.....	26
Accessories for EUROSTOP ranges.....	13	RATIONNEL +.....	27
■ Butterfly valves - concentric	14	TANGO.....	27
Wafer.....	14	BI 97	28
Lug	15	FH2.....	28
S20 Butterfly Valves	16	Accessories for fire hydrant.....	29
S13 Butterfly Valves.....	16	■ Housing connection	30
■ Air valves	17	Multi-turn cock ferrule	30
Venting function type 100 series	17	■ General Accessories	31
Double function type S series	17	Flange jointing material	31
Triple function type D series	17	Surface box.....	32
Triple function VENTEX	18		

EURO 20® New range



- Reliable and original design for optimized functions
- Durability and long service
- Product in compliance with the standards
- Compatibility with drinking water
- Easy operation and maintenance

Fitted on pipes in water systems, these valves are closed to interrupt the water supply or opened to allow to flow in systems.

To cater for operation in specific conditions, Euro 20 gate valves are also available in motorized versions for nominal diameters (DN) from 40 to 400.

Main features

- Ductile iron construction provides high strength to weight ratio
- Excellent corrosion resistance thanks to:
 - autoclave bonnet removes need for body bonnet bolting,
 - wax-filled bolt holes (DN 200 – 400)
- Efficient operation after long periods of no-use in either opened or closed positions
- Bush can be replaced under pressure
- Full clear bore for optimum flow
- Nylon gliders on wedge reduce friction and hence operating torques
- 250 microns mini Blue fusion bonded epoxy coating with 250 microns mini
- High tensile stainless steel stem ensures strength and corrosion resistance

A complete, tailored range

- Nominal diameters ranging from DN40 to DN400
- PFA – allowable operating pressure – of 16 bar to 25 bar
- A wide range of products allowing valves to be connected to various piping materials

Options available

- Cap to operated
- Handwheel operated
- Bevel gearbox
- Actuator operated

Euro 20 New® : durability, performance and ergonomics Made in France

	TYPE 21 S15 serie PFA 16 bar	TYPE 21 S15 serie PFA 25 bar	TYPE 23 S14 serie PFA 16 bar	TYPE 25 PFA 16 bar	TYPE 27 PFA 16 bar	BLUTOP® PFA 16 bar
40	E21 NEW DN 40-300	DN 60-200	E23 NEW DN 40-300	DN 80-150	DN 65-150	DE 75-160
50						
65/60						
80						
100						
125	E23 DN 350-400					
150						
200						
250						
300						
350						
400						

■ NEW type 21
S15 (long):
Long face to face
S15 = DN + 200 mm



■ NEW type 23
S14 (short):
Short face to face
S14 = 0,4 DN + 150 mm



■ Type 25:
Socket for cast
iron pipes



■ Type 27:
BU sockets for cast
iron pipes



■ Type BLUTOP®:
Blutop® seal socket for
FD Blutop® pipes and
plastic pipes





from DN 40
to DN 300



E20 NEW type 23 S14
DN40-300

EURO 20® NEW type 23 Series S14 PFA 16 bar

Flanged connection.
ISO 5752 EN 558 Serie S14 (short)

Complies with European standard EN 1074-1 and 2.

DN	CC without accessory		ACC with cap		weight kg	packaging parts
	PN10	PN16	PN10	PN16		
40	RBA40BBCH		RBA40BDCH		8,8	20*
50	RBA50BBCH		RBA50BDCH		10,6	20*
65/60	RBA60BBJH		RBA60BDJH		12,7	16*
65/65	RBA65BNCH		RBA65BDAH		12,7	16*
80	RBA80BNCH		RBA80UDBH		14,3	10*
100	RBB10BNCH		RBB10BDBH		19,0	10*
125	RBB12BNCH		RBB12UDCH		24,3	7*
150	RBB15BBCH		RBB15BDCH		32,3	5*
200	RBB20BBBH	RBB20BBAH	RBB20BDBH	RBB20BDAH	48,0	6**
250	RBB25BBBH	RBB25BBAH	RBB25BDBH	RBB25BDAH	82,0	4**
300	RBB30BBBH	RBB30BBAH	RBB30BDBH	RBB30BDAH	125,0	3**
350 (*)	RDB35BBBH	RDB35BBAH	RDB35BDBH	RDB35BDAH	175,0	2**
400 (*)	REB40BBBH	REB40BBAH	REB40BDBH	REB40BDAH	290,0	2**

* Europalett 1200 x 800 ** Palett 1600 x 1150

(*) Current EURO 20®

DN350 = passage in 300 mm

EURO 20® NEW type 21 Series S15 PFA 16 bar

Flanged connection.
ISO 5752 EN 558 Serie S15 (Long)

Complies with European standard EN 1074-1 and 2.



E20 NEW type 21 S15

DN	CC with cap		ACC with cap		PN10 weight kg	packaging parts
	PN10	PN16	PN10	PN16		
40	RBA40AACH		RBA40ADCH		9,1	20*
50	RBA50AABH		RBA50ADCH		10,7	20*
65/60	RBA60APCH		RBA60TDJH		13,6	16*
65/65	RBA65APCH		RBA65TDCH		13,6	16*
80	RBA80APCH		RBA80ADCH		15,3	12*
100	RBB10APCH		RBB10ADCH		20,8	10*
125	RBB12APCH		RBB12ADCH		26,6	8*
150	RBB15APCH		RBB15ADCH		36,1	5*
200	RBB20AABH	RBB20AAAHAH	RBB20ADBH	RBB20ADAH	54,1	6**
250	RBB25AABH	RBB25AAAHAH	RBB25ADBH	RBB25ADAH	92,0	4**
300	RBB30AABH	RBB30AAAHAH	RBB30ADBH	RBB30ADAH	138,0	3**

For other versions and for DN 400, 500 and 600, please consult our Regional Agencies.

* Europalett 1200 x 800 ** Palett 1600 x 1150



EURO 20® type 21 PFA 10/16 bar

Flange drilling ISO PN 10 or 16.
ISO 5752 EN 558 Serie S15 (Long)
Complies with EN 1074-1 et EN 1074-2



DN	PFA	weight (kg)	packaging batch	reference		
				Standard version		Reinforced version CC without cap
				ACC with cap	CC without cap	
40	10/16	10.6	20*	REA40ADCH	REA40ABBH	please consult us
50	10/16	11.5	20*	REA50ADCH	REA50ABBH	
65 / 60	10/16	15.2	12*	RDA65TDJH	RDA65ABJH	RDA65ANJP
65 / 65	10/16	16.5	12*	RDA65TDCH	RDA65ABCH	RDA65ANCP
80	10/16	16.5	10*	RDA80ADCH	RDA80ABCH	RDA80ANCP
100	10/16	20.0	10*	RDB10ADCH	RDB10ABCH	RDB10ANCP
125	10/16	28.1	6*	RDB12ADCH	RDB12ANCH	RDB12ANCP
150	10/16	36.3	5*	RDB15ADCH	RDB15ANCH	RDB15ANCP
200	10	75	6*	RDB20ADBH	RDB20ABBH	RDB20ABBP
200	16	75	6**	RDB20ADAH	RDB20ABAH	RDB20ABAP
250	10	121	4**	RDB25ADBH	RDB25ABBH	RDB25ABBP
250	16	121	4**	RDB25ADAH	RDB25ABAH	RDB25ABAP
300	10	174	3**	RDB30ADBH	RDB30ABBH	RDB30ABBP
300	16	174	3**	REB30ADAH	REB30ABAH	REB30ABAP

* Europalette 1200 x 800 ** Palette 1600 x 1150



EURO 20® type 23 PFA 10/16 bar

DN 40 up to DN 300



Flange drilling ISO PN 10 or 16 bar.
Face to face: series 14 (ISO 5752, EN 558-1).
ISO short pattern (0,4OD+150) mm.

DN	PFA	weight (kg)	packaging batch	reference		
				Standard version		Reinforced version
				ACC with cap	CC without cap	CC without cap
40	10/16	8.5	20	please. consult us	REA40BBCH	please. consult us
50	10/16	10.5	20	—	REA50BBCH	—
65 / 60	10/16	14.2	12	RGA65BDJH	RDA65BBJH	RDA65BNJP
65 / 65	10/16	14.2	12	RDA65BDCH	RDA65BNCH	RDA65BNCP
80	10/16	15.5	10	RDA80DBDH	RDA80BNCH	RDA80BNCP
100	10/16	19	10	RDB10DBDH	RDB10BNCH	RDB10BNCP
125	10/16	25.6	6	RDB12BDCH	RDB12BNCH	RDB12BNCP
150	10/16	32.2	5	RDB15BDCH	RDB15BBCH	RDB15BNCP
200	10	66	6	RDB20DBDH	RDB20BBBH	RDB20BBBP
200	16	66	6	RDB20BDAH	RDB20BBAH	RDB20BBAP
250	10	108	4	RDB25DBDH	RDB25BBBH	RDB25BBBP
250	16	108	4	RDB25BDAH	RDB25BBAH	RDB25BBAP
300	10	157	3	RDB30DBDH	RDB30BBBH	RDB30BBBP
300	16	157	3	RDB30BDAH	RDB30BBAH	RDB30BBAP
350	10	177	2	RDB35DBDH	RDB35BBBH	RDB35BBBP
350	16	177	2	RDB35BDAH	RDB35BBAH	RDB35BB4P
400	10	298	2	RDB40DBDH	RDB40BBBH	RDB40BBBP
400	16	298	2	RDB40BDAH	RDB40BBAH	RDB40BBAP

EURO 20® type 23 PFA 16 bar motorised



DN	weight (kg)	reference	
		PN10	PN 16
65	39		RDA65BHCH
80	40		RDA80BHCH
100	48		RDB10BHCH
125	55		RDB12BHCH
150	63		RDB15BHCH
200	130	REB20BHBH	REB20BHAH
250	165	REB25BHBH	REB25BHAH
300	199	REB30BHBH	REB30BHAH
350	244	REB35BHBH	REB35BHAH
400	365	REB40BHBH	REB40BHAH

For long version E20 type 21 motorised: change the letter "B" (5th position) for the letter "A".



EURO 20® type 21 PFA 25 bar

Flange drilling ISO PN 25.
Face to face: series 15 (ISO 5752, EN 558-1).
ISO long pattern (OD+200) mm.



DN	weight (kg)	packaging batch	reference	
			Standard version	
			ACC with cap	CC without cap
65 / 60	15	12*	RDA60ADDH	RDA60AADH
65 / 65	15	12*	RDA65ADDH	RDA65AADH
80	16.5	10*	RDA80ADDH	RDA80AADH
100	21.5	10*	RDB10ADDH	RDB10AADH
125	31	6*	RDB12ADDH	RDB12AADH
150	41	5*	RDB15ADDH	RDB15AADH
200	76	6**	RDB20ADDH	RDB20AADH

Reinforced version: please, consult us.
* Europalette 1200 x 800 ** Palette 1600 x 1150



EURO 20® for BLUTOP® PFA 16 bar

DN/OD	ACC with cap		CC without cap	
	weight (kg)	reference	weight (kg)	reference
75	12.3	RDL75KDXH	12.1	RDL75KBXH
90	12.8	RDL90KDXH	12.6	RDL90KBXH
110	16.2	RDM11KDXH	16.0	RDM11KBXH
125	22.8	RDM12KDXH	22.6	RDM12KBXH
160	30.0	RDM16KDXH	29.8	RDM16KBXH

Valve delivered without joint, with cap.



Pipe connexion ductile iron - joint BLUTOP® PFA 16 bar

DN/OD	unanchored		anchored	
	weight (kg)	reference	weight (kg)	reference
75	0.059	JXL75BAM	0.067	JXL75CAM
90	0.067	JXL90BAM	0.076	JXL90CAM
110	0.081	JXM11BAM	0.093	JXM11CAM
125	0.108	JXM12BAM	0.118	JXM12CA
140	0.140	JXM14BAM	0.190	JXM14CA
160	0.169	JXM16BAM	0.221	JXM16CA



Pipe connexion PVC-U, PVC-BO and PE - Junction IZIFIT® anchored PFA 16 bar and PFA 10 bar for PVC-BO

DN/OD	weight (kg)	reference
75	0.059	JIL75CA
90	0.067	JIL90CA
110	0.081	JIM11CA
125	0.108	JIM12CA
140*	2.80 + 0.14	JZM14VX + JXM14BA
160*	3.10 + 0.17	JZM16VX + JXM16BA

* DN 140 and 160, anchoring flange + gasket.

EURO 20® type 25 PFA 16 bar

Socket connections for Ductile Iron Pipes.
Standard version.

DN/OD	DE	weight (kg)	reference (*)	
			ACC with cap	CC without cap
80	98	15.3	RDA80DDXH	RDA80DBXH
100	118	19.3	RDB10DDXH	RDB10DBXH
125	144	27.3	RDB12DDXH	RDB12DBXH
150	170	33.7	RDB15DDXH	RDB15DBXH

(*) two joints included.

EURO 20® type 27 PFA 16 bar for flanges adaptators

Spigot ends. For use by insertion to replace an old valve.

DN	DE	weight (kg)	reference	
			ACC with cap	CC without cap
65	77	10.2	RDA65FDXH	RDA65FBXH
80	98	11.8	RDA80FDXH	RDA80FBXH
100	118	15.1	RDB10FDXH	RDB10FBXH
125	144	22.6	RDB12FDXH	RDB12FBXH
150	170	30.1	RDB15FDXH	RDB15FBXH



EURO 20® APPROVED



E20 "Wall Indicator"



E20 "Post Indicator"

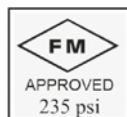

DN	pressure		Length	PN (flange)	Without flange with Square AWWA		With flange & Square AWWA		E20 with wall-indicator*		E20 with post-indicator*	
	mm	inch			psi	weight (kg)	reference	weight (kg)	reference	weight (kg)	reference	weight (kg)
100	4	235	type 21	10/16	20.8	RDB10AQCHR	33	RDB10AMCHR	64	RDB10AMCHW	173	RDB10AMCHP
				10/16	19.8	RDB10BQCHR	31	RDB10BMCHR	62	RDB10BMCHW	171	RDB10BMCHP
type 23	10/16		28.9	RDB12AQCHR	41	RDB12AMCHR	72	RDB12AMCHW	181	RDB12AMCHP		
	10/16		26.4	RDB12BQCHR	38.5	RDB12BMCHR	70	RDB12BMCHW	179	RDB12BMCHP		
125	5		type 21	10/16	36.9	RDB15AQCHR	50	RDB15AMCHR	81	RDB15AMCHW	190	RDB15AMCHP
				10/16	33.2	RDB15BQCHR	46.3	RDB15BMCHR	78	RDB15BMCHW	187	RDB15BMCHP
150	6		type 21	10	76.2	RDB20AQBHR	95	RDB20AMBHR	126	RDB20AMBHW	235	RDB20AMBHP
				16	76.2	RDB20AQahr	95	RDB20AMahr	126	RDB20AMahw	235	RDB20AMahp
200	8		type 23	10	68.2	RDB20QBHR	87	RDB20BMBHR	120	RDB20BMBHW	229	RDB20BMBHP
				16	68.2	RDB20QBAHR	87	RDB20BMAHR	120	RDB20BMAHW	229	RDB20BMAHP
250	10		type 21	10	121.8	RDB25AQBHR	148	RDB25AMBHR	179	RDB25AMBHW	288	RDB25AMBHP
				16	121.8	RDB25QAHR	148	RDB25AMahr	179	RDB25AMahw	288	RDB25AMahp
300	12	type 23	10	110.0	RDB25QBHR	136.2	RDB25BMBHR	167	RDB25BMBHW	276	RDB25BMBHP	
			16	110.0	RDB25QBAHR	136.2	RDB25BMAHR	167	RDB25BMAHW	276	RDB25BMAHP	
300	12	type 21	10	182.2	RDB30AQBHR	159	RDB30AMBHR	240	RDB30AMBHW	349	RDB30AMBHP	
			16	182.2	RDB30QAHR	159	RDB30AMahr	240	RDB30AMahw	349	RDB30AMahp	
400	16	type 23	10	159.2	RDB30QBHR	182.4	RDB30BMBHR	221	RDB30BMBHW	325	RDB30BMBHP	
			16	159.2	RDB30QBAHR	182.4	RDB30BMAHR	221	RDB30BMAHW	325	RDB30BMAHP	
400	16	175	type 23	10	299.5	REB40QBHR	322.7	REB40BMBHR	329	REB40BMBHW	393	REB40BMBHP
				16	299.5	REB40QBAHR	322.7	REB40BMAHR	329	REB40BMAHW	393	REB40BMAHP

(*) Reference without position indicator. For references with position electric, please consult us.

Protection tube



PVC

reference	length (m)	weight (kg)
RAB60AD	0.6	0.7
RAB90AD	0.9	1.1
RAC11AD	1.1	1.4

Ductile cast iron

reference	length (m)	weight (kg)
RAC10AB	1.0	6.8
RAC15AB	1.5	10.2

Coupling for protection tube



PVC		CAST IRON	
weight (kg)	reference	weight (kg)	reference
0.1	RAA80ED	0.1	RAA80DB

Support for protection tube



RVOC type	DN	PVC		CAST IRON	
		weight (kg)	reference	weight (kg)	reference
EURO 20 NEW S14 & S15	40-50	0.1	RAA80BDN	1.55	RAA80BBN
	65-150	0.1	RAA80CDN	2.48	RAA80CBN
	200-400	0.1	RAB20CDN	3.15	RAB20CBN
EURO 20®	40-150	0.1	RAA80BDN	1.55	RAA80BBN
	200-400	0.1	RAA80CDN	2.48	RAA80CBN

Operating extension spindle including cap



Square section 28 x 28 including cap and set screw.

length (m)	weight (kg)	reference
1	7.7	RAA28F1
2	15	RAA28F2

Spindle guiding covers for protection tube

PVC

reference	weight (kg)
RAA80ED	0.1

CAST IRON

reference	weight (kg)
RAA80DB	0.8



Extension spindle coupling

EURO 20 NEW	EURO 20®		weight (kg)	reference
	ACC	CC		
DN40-50	DN40-80	DN40-50	0.85	RAA15G
DN65-80	DN100-125 and DN150 < 2011	DN65-80	0.86	RAA18G
DN100-150	DN150 (after 2011)	DN100-150	0.81	RAA19G
DN200	DN200-300		0.78	RAA25G
-	DN350-400		0.74	RAA29G



Steel Handwheel for EURO 20 NEW and EURO 20®



DN	Ø handwheel	CC		ACC	
		weight (kg)	reference	weight (kg)	reference
40 and 50	150	0.4	RAA15UAK	0.4	162045
65 and 80	150	0.4	RAA18UAK	0.4	254301
100 - 125 - 150	200	0.75	RAA21UAK	0.75	229993
200	350	2.5	RAA26UAK	2.5	162069
250 and 300	500	5	RAA24UAK	5	162063
350 and 400	500	3.5	RAA29UAK	3.5	162221

T Key, 1.5 m Length



reference	weight (kg)
215205	6



Fixed length recuttable operating Extension

EURO 20 NEW DN	Dc = 1000 mm		Dc = 1250 mm		Dc = 1500 mm		Dc = 2000 m	
	ref.	weight kg	ref.	weight kg	ref.	weight kg	ref.	weight kg
40-50	259271	2.3	259285	2.7	259286	3	259287	3.8
65-80	259288	3.1	259289	3.7	259290	4.4	259291	5.6
100-125	259293	3	259294	3.6	259295	4.3	259296	5.5
150	259297	2.9	259298	3.5	259299	4.1	259300	5.4
200 à 300	259301	4.4	259302	5.6	259303	6.8	259304	9.2

EURO 20®		Dc = 1000 mm		Dc = 1250 mm		Dc = 1500 mm	
ACC	CC	reference	weight kg	reference	weight kg	reference	weight kg
40 à 80	40 - 50	162010	2.3	162016	2.7	162021	3
100-125	65 - 80	162011	3.1	162017	3.7	162169	4.4
-	100	162012	3	162018	3.6	162022	4.3
150	125 - 150	162013	2.8	162019	3.4	162023	4.1
200 à 300	200 à 300	162014	4.4	162020	5.6	162024	6.8
350 à 400	350 à 400	162015	4	162168	5.2	171249	6.4

Dc : Depth of cover
Include operating cap square 30x30



Telescopic Extension

EURO 20 NEW DN	Low Dc. (mm)		Average Dc. (mm)		Important Dc. (mm)		Very important Dc. (mm)	
	ref.	weight kg	ref.	weight kg	ref.	weight kg	ref.	weight kg
40-50	900-1150		1050-1450		1350-2050		1700-2600	
	259175	2.3	259176	2.9	259177	3.5	259178	3.5
65-80	900-1100		1050-1400		1350-2000		1650-2600	
	259179	3	259180	4	259191	5	259192	6.3
100 à 150	950-1200		1100-1500		1450-2000		1700-2700	
	259193	3	259194	3.5	259195	4.6	259196	6.3
200	1150-1400		1250-1650		1550-2250		1950-3050	
	259197	6.6	259198	7.0	259199	10	259200	12.5

EURO 20®		Dc mm	ref.	weight kg	Dc mm	ref.	weight kg
ACC	CC						
40-50-65-80	40 - 50	900-1150	162043	2.5	1050-1450	162102	3
100-125	65 - 80	900-1100	162127	3	1050-1400	162103	4
-	100	900-1150			1050-1450		
-	125	950-1200	162099	3	1100-1500	162104	4
150	150	950-1200			1100-1500		
200	200	1150-1400			1250-1650		
250	250	1250-1500	162100	6	1350-1700	162105	7.5
300	300	1300-1550			1350-1750		
350	350	1150-1300			1300-1600		
400	400	1350-1550	162101	6	1500-1800	162106	7.5

For higher depth of cover please consult us

Headstock

with opening indicator or handwheel (1)

without opening indicator or handwheel (2)

(with flange to motorised version)

DN	weight (kg)	CC reference	ACC reference
40-50	49	162001	162155
60/65-80-100		162002	162158
125-150		162004	162005
200-250		162159	166986
300-350		162006	166987
400		162160	

DN	flange	weight (kg)	reference
40-150	F10	17	162156
200-400	F14	28	162157

protection plate

DN	weight (kg)	reference
40-150	1.25	162295
200-400	1.25	184276

Position indicator kit

DN	electric		mechanic		EURO 20® NEW adaptor		
	reference	weight kg	reference	weight kg	DN	reference	weight kg
40 - 50	226810	3.2	173571	1.6	40 - 50	279224	0.3
65 - 80	226821	3.6	173572	1.6	65 - 100	270835	0.2
100 à 150	226822	3.9	173573	1.7	125 - 150	271153	0.2
200 à 300	224981	5.8	173574	3.1	200 - 400	267121	0.6
400	259258	6.0					

For ACC, please consult us.

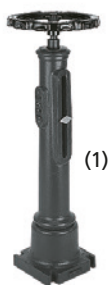

(1)



(2)



electrical



mecanic

- EUROSTOP® flanged butterfly valves, long pattern, double eccentricity with JPA automatic seal in disc for market water.
- Body and butterfly in ductile iron with epoxy coating 250 microns mini according to EN 14901.
- In compliance with EN593, EN1074-1 and 2 with 2,500 cycles endurance test.
- Gearbox Auma protection IP68-8 (submersion up to 8 m head of water).
- Options for reinforced material, on demand



EUROSTOP® BB JPAi manual version

Supplied with handwheel and position indicator.
Clockwise close version. For ACC, please consult us.

DN	PFA 10 bar CC Flanges drilled ISO PN 10		PFA 16 bar CC Flanges drilled ISO PN 16		PFA 25 bar CC Flanges drilled ISO PN 25	
	weight (kg)	reference	weight (kg)	reference	weight (kg)	reference
150	35	RPB15NGAH	35	RPB15NGAH	39	RPB15NGDH
200	46	RPB20NGBH	46	RPB20NGAH	63	RPB20MGDH
250	67	RPB25NGBH	67	RPB25NGAH	88	RPB25NGDH
300	86	RPB30NGBH	88	RPB30NGAH	120	RPB30NGDH
350	111	RPB35NGBH	132	RPB35NGAH	174	RPB35NGDH
400	139	RPB40NGBH	170	RPB40NGAH	221	RPB40MGDH
450	183	RPB45NGBH	207	RPB45NGAH	300	RPB45NGDH
500	215	RPB50NGBH	265	RPB50NGAH	348	RPB50NGDH
600	302	RPB60NGBH	414	RPB60NGAH	636	RPB60NGDH
700	453	RPB70NGBH	543	RPB70NGAH	975	RPB70MGDH
800	640	RPB80NGBH	986	RPB80MGAH	1243	RPB80MGDH
900	861	RPB90MGBH	1152	RPB90MGAH	1693	RPB90MGDH
1000	1249	RPC10MGBH	1479	RPC10MGAH	2091	RPC10MGDH
1200	1831	RPC12MGBH	2357	RPC12MGAH	3398	RPC12MGDH
1400	2512	RPC14MGBH	3500	203207	4067	RPC14MGDH
1500	2873	RPC15MGBH	4281	203213	6052	203217
1600	3470	RPC16MGBH	4916	203222	6200	RPC16MGDH
1800	4965	203233	6974	203237		
2000	6560	203244	8500	203248		

NEW

EUROSTOP® ES Manual operation



Epoxy seat
Rotork manual gearbox

PN10-16
DN150-800
Field of application: Drinking water, raw water.

DN	Closing direction	Ref PN10	Ref PN16
150	CC	265565	265565
200	CC	265566	265567
250	CC	265569	265571
300	CC	265572	265574
350	CC	265577	265578
400	CC	265579	265583
450	CC	265584	265586
500	CC	265587	265588
600	CC	265589	265590
700	CC	265592	265593
800	CC	265594	-

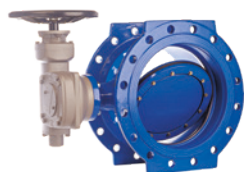

EUROSTOP® BB JPAi motorisable

Gearbox supplied with handwheel and position indicator.
 Mounting flange for accessories F10 or F14 according to EN ISO5210.
 Clockwise close version. For ACC, please consult us.

DN	PFA 10 bar CC Flanges drilled ISO PN 10		PFA 16 bar CC Flanges drilled ISO PN 16		PFA 25 bar CC Flanges drilled ISO PN 25	
	weight (kg)	reference	weight (kg)	reference	weight (kg)	reference
150	35	RPB15NHCH	35	RPB15NHCH	39	RPB15NHDH
200	46	RPB20NHBH	46	RPB20NHAH	63	RPB20NCDH
250	67	RPB25NCBH	67	RPB25NCAH	88	RPB25NHDH
300	86	RPB30NCBH	88	RPB30NHAH	120	RPB30NCDH
350	111	RPB35NHBH	132	RPB35NCAH	174	RPB35NCDH
400	139	RPB40NCBH	170	RPB40NCAH	221	RPB40NHDH
450	183	RPB45NCBH	207	RPB45NHAH	300	RPB45NCDH
500	215	RPB50NCBH	265	RPB50NHAH	348	RPB50NCDH
600	302	RPB60NHBH	414	RPB60NCAH	520	RPB60NHDH
700	453	RPB70NCBH	543	RPB70NCAH	975	RPB70MHDH
800	640	RPB80NHBH	926	RPB80MHAH	1243	RPB80MHDH
900	861	RPB90MHBH	1152	RPB90MCAH	1693	RPB90MHDH
1000	1249	RPC10MHBH	1479	RPC10MHAH	2091	RPC10MQDH
1200	1831	RPC12MHBH	2357	RPC12MHAH	3430	RPC12MHDH
1400	2512	RPC14MQBH	3590	RPC14MHAH	4067	RPC14MHDH
1500	2873	RPC15MQBH	4020	RPC15MHAH	6052	203216
1600	3470	RPC16MQBH	4920	RPC16MHAH	6200	RPC16MHDH
1800	4965	165541	6974	RPC18MHAH		
2000	6560	203241	8353	RPC20MHAH		

On request : reinforced material



NEW

EUROSTOP® LM – Including dismantling joint



Double offset Eurostop including a dismantling joint for ease of maintenance, available on manual and motorizable versions
 PN10-16
 DN300-600

DN	Closing direction	Manual version		Motorisable version		Motorized version
		PN10	PN16	PN10	PN16	
300	CC	261639	261640	261648	261649	Consult us
400		261641	261642	261650	261651	
500		261643	261644	261652	261653	
600		261645	261646	261654	261655	



EUROSTOP® BB JPAi motorized

Motorized version SA NORM by Auma.

IP-68-8 protective version (submersion up to max. 8 m head of water for max. 96 hours including 10 operations open closed).

Gearbox with mechanical position indicator.

Standard version is for clockwise close (CC) type. Consult us for anticlockwise close (ACC) type.

DN	PFA 10 bar CC Flanges drilled ISO PN 10		PFA 16 bar CC Flanges drilled ISO PN 16		PFA 25 bar CC Flanges drilled ISO PN 25	
	weight (kg)	reference	weight (kg)	reference	weight (kg)	reference
150	56	RPB15NECH	56	RPB15NECH	60	RPB15NEDH
200	67	RPB20NEBH	67	RPB20NEAH	81	RPB20NDDH
250	83	RPB25NDBH	85	RPB25NDAH	109	RPB25NEDH
300	104	RPB30NDBH	111	RPB30NEAH	144	RPB30NDDH
350	132	RPB35NEBH	156	RPB35NDAH	189	RPB35NDDH
400	161	RPB40NDBH	185	RPB40NDAH	250	RPB40NEDH
450	181	RPB45NDBH	248	RPB45NEAH	321	RPB45NDDH
500	230	RPB50NDBH	294	RPB50NEAH	374	RPB50NDDH
600	331	RPB60NEBH	440	RPB60NDAH	593	RPB60NEDH
700	472	RPB70NDBH	566	RPB70NDAH	975	RPB70MEDH
800	665	RPB80NEBH	986	RPB80MEAH	1243	RPB80MEDH
900	861	RPB90MEBH	1044	RPB90MDAH	1725	RPB90MECDH
1000	1249	RPC10MEBH	1479	RPC10MEAH	2123	RPC10MEDH
1200	1831	RPC12MEBH	2389	RPC12MEAH	3430	RPC12MEDH
1400	2544	RPC14MEBH	3622	RPC14MEAH	4600	203209
1500	2905	RPC15MEBH	4313	RPC15MEAH	6117	203215
1600	3520	RPC16MEBH	4948	RPC16MEAH	6265	203224
1800	4997	RPC18MEBH	7039	RPC18MEAH		
2000	8418	RPC20MEBH	8418	RPC20MEAH		

SA NORM standard Auma equipment :

- 400 V AC current, 3-phase 50 Hz
- Short-time duty S2 - 15 minutes (according to IEC 34-1)
- Insulation class: F tropicalized
- Thermic protection for each phase with thermo-switches (NC)
- Two switches (opened - closed) SPDT type
- Torque switching adjustable DPDT type
- With motor heater incorporated 110-250 V AC/DC automatic regulation
- Intermittent light working
- Manual drive for setting and emergency operation is possible un-lockable



EUROSTOP® BB JPAi buried service

The butterfly valve is supplied bare shaft without cap top. It's possible to supply with the cap top or with the coupling.

Gearbox has not mechanical position indicator. Gearbox is protective with a supplementary external thick of epoxy powder blue coating 80 microns.

Standard version is for clockwise close (CC) type. Consult us for anticlockwise close (ACC) type.



DN	PFA 10 bar CC Flanges drilled ISO PN 10		PFA 16 bar CC Flanges drilled ISO PN 16		PFA 25 bar CC Flanges drilled ISO PN 25	
	weight (kg)	reference	weight (kg)	reference	weight (kg)	reference
150	36	RPB15NFCH	36	RPB15NFCH	43	RPB15NFDH
200	49	RPB20NFBH	49	RPB20NFAH	73	RPB20NFDH
250	81	RPB25NFBH	81	RPB25NFAH	93	RPB25NFDH
300	101	RPB30NFBH	101	RPB30NFAH	138	RPB30NFDH
350	123	RPB35NFBH	150	RPB35NFAH	213	RPB35NFDH
400	159	RPB40NFBH	216	RPB40NFAH	249	RPB40NFDH
450	223	RPB45NFBH	252	RPB45NFAH	280	RPB45NFDH
500	254	RPB50NFBH	307	RPB50NFAH	404	RPB50NFDH
600	319	RPB60NFBH	476	RPB60NFAH	636	RPB60NFDH
700	497	RPB70NFBH	675	RPB70NFAH	975	RPB70MFDH
800	793	RPB80NFBH	986	RPB80MFAH	1243	RPB80MFDH
900	861	RPB90MFBH	1152	RPB90MFAH	1693	RPB90MFDH
1000	1249	RPC10MFBH	1479	RPC10MFAH	2091	RPC10MFDH
1200	1831	RPC12MFBH	2357	RPC12MFAH	3398	RPC12MFDH
1400	2515	RPC14MFBH	3590	RPC14MFAH	4067	RPC14MFDH
1500	2873	RPC15MFBH	5582	RPC15MFAH	6052	RPC15MFDH
1600	3470	RPC16MFBH	4916	RPC16MFAH	6200	RPC16MFDH
1800	4965	RPC18MFBH	6974	RPC18MFAH		
2000	6560	RPC20MFBH	8353	RPC20MFAH		

Protection tube, coupling, spindle guiding, tube support, extension spindle for EUROSTOP®

		PVC			CAST IRON		
		reference	length (m)	weight (kg)	reference	length (m)	weight (kg)
Protection tube		RAB60AD	0.6	0.7	RAC10AB	1.0	6.8
		RAB90AD	0.9	1.1	RAC15AB	1.5	10.2
		RAC11AD	1.1	1.4			
Coupling for protection tube		RAA80ED		0.1	RAA80DB		0.8
Spindle guiding covers for protection tube		162033		0.8	162032		0.4
Protection tube for butterfly valve	F10	162030		0.15	162030		0.15
	F14	162029		2.2	162029		2.2
Extension spindle*		RAA28F1	1	7.7	RAA28F1	1	7.7

* Available for DCI and PVC, with square 28 x 28 mm. This kit contents operating top cap and pressure bolt.

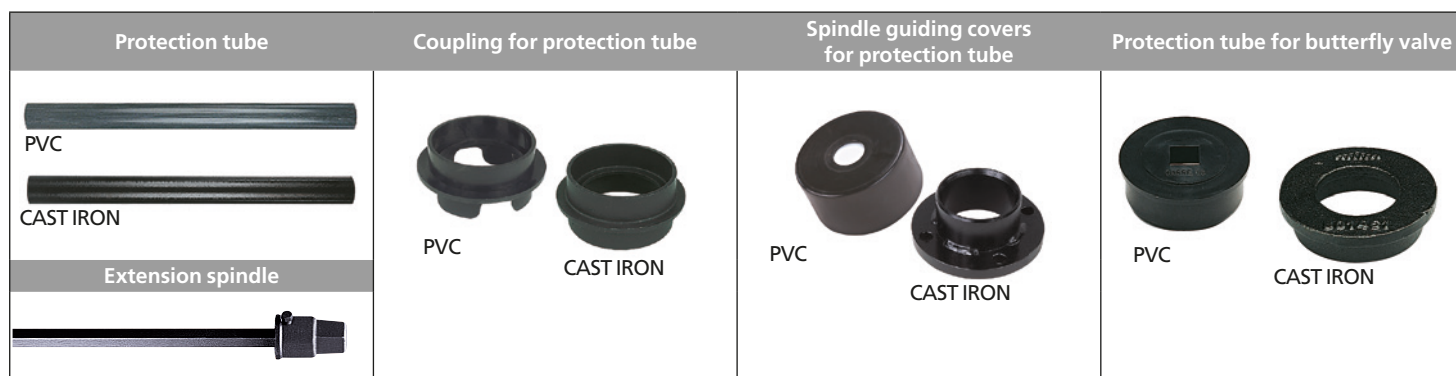

Operating cap with machined keyway for butterfly valve



shaft diameter	weight (kg)	reference
Ø 20	0.9	162051
Ø 30	1.1	162086

Extension spindle coupling with machined keyway for butterfly valve



shaft diameter	weight (kg)	reference
Ø 20	0.8	RAA20M
Ø 30	0.8	RAA30M

Telescopic operating unit, length 1 to 7 meters



PN	DN	Ø wedge (mm)	length and weight								
			1.10-1.50 m	1.20-1.80 m	1.35-2.00 m	1.70-2.70 m	2.60-4.50 m	3.10-5.50 m	3.40-6.00 m	3.90-7.00 m	
PN10	150 to 1200	20	4.80 kg	4.80 kg	5.20 kg	5.40 kg	7.30 kg	12 kg	13.90 kg	15 kg	17 kg
	1400 to 1600	30	225196	225147	225190	225191	225192	225193	225194	225195	
	1800	20	225197	225147	225190	225191	225192	225193	225194	225195	
	2000	30	225197	225198	225199	225200	225201	225202	225203	225204	
PN16	150 to 1000	20	225196	225147	225190	225191	225192	225193	225194	225195	
	1200	30	225197	225198	225199	225200	225201	225202	225203	225204	
	1400 to 1600	20	225196	225147	225190	225191	225192	225193	225194	225195	
PN25	1800 to 2000	30	225197	225198	225199	225200	225201	225202	225203	225204	
	150 to 900	20	225196	225147	225190	225191	225192	225193	225194	225195	
	1000	30	225197	225198	225199	225200	225201	225202	225203	225204	
	1200 to 1400	20	225196	225147	225190	225191	225192	225193	225194	225195	
	1500 to 1600	30	225197	225198	225199	225200	225201	225202	225203	225204	

- Concentric butterfly valves short pattern with joint/elastomer in body.
- Body in ductile iron GG5-40 and epoxy powder 150 microns, EPDM elastomer with ACS.
- Disc/butterfly in two versions: ductile iron GG5-40 or stainless and steel CF8M.
- According to EN 1074-1 and 2, with 2500 cycles endurance test.
- Other material and options on demand, consult dedicated catalogue about concentric butterfly valve range

WAFER DN 40-1200 PN 16 for industrial solutions



DN	PN	HANDLEVER disc			GEARBOX WITH HANDWHEEL disc		
		weight (kg)	DI + epoxy 150µ reference	Stainless steel reference	weight (kg)	DI + epoxy reference	Stainless steel reference
40	10/16	2.1	VWA40FLCWE	VWA40ALCWE	2.9	VWA40FBCWE	VWA40ABCWE
50	10/16	2.9	VWA50FLCWE	VWA50ALCWE	3.7	VWA50FBCWE	VWA50ABCWE
65	10/16	3	VWA65FLCWE	VWA65ALCWE	3.8	VWA65FBCWE	VWA65ABCWE
80	10/16	3.6	VWA80FLCWE	VWA80ALCWE	4.3	VWA80FBCWE	VWA80ABCWE
100	10/16	4.4	VWB10FLCWE	VWB10ALCWE	5.2	VWB10FBCWE	VWB10ABCWE
125	10/16	6.6	VWB12FLCWE	VWB12ALCWE	7.5	VWB12FBCWE	VWB12ABCWE
150	10/16	7.6	VWB15FLCWE	VWB15ALCWE	8.7	VWB15FBCWE	VWB15ABCWE
200	16	11.6	VWB20FLAWE	VWB20ALAWA	13.6	VWB20FBAWE	VWB20ABAWA
250	16	22.2	VWB25FLAWE	VWB25ALAWA	24	VWB25FBAWE	VWB25ABAWA
300	16	31.2	VWB30FLAWE	VWB30ALAWA	33	VWB30FBAWE	VWB30ABAWA
350	16	Please contact us			39	VWB35FBAWE	VWB35ABAWA
400	16				64.6	VWB40FBAWE	VWB40ABAWA
450	16				99.2	VWB45FBAWE	VWB45ABAWA
500	16				132	VWB50FBAWE	VWB50ABAWA
600	16				205	VWB60FBAWE	VWB60ABAWA
700	16				331.8	VWB70FBAWE	VWB70ABAWA
800	16				423.6	VWB80FBAWE	VWB80ABAWA
900	16				557	VWB90FBAWE	VWB90ABAWA
1000	16				659	VWA10FBAWE	VWC10ABAWA
1200	16				1257.6	VWA12FBAWE	VWC12ABAWA

Consult us for PN10.

RAP WAFER DN 40 - 1200 motorised AUMA three-phase



Wafer motorised electric AUMA with disc in ductile iron

DN	weight (kg)		reference	
	PN10/PFA 10	PN16/PFA 16	PN10/PFA 10	PN16/PFA 16
40		10.00		VWA40FECWE
50		10.70		VWA50FECWE
60		11.30		VWA60FECWE
65		11.30		VWA65FECWE
80		11.50		VWA80FECWE
100		12.30		VWB10FECWE
125		24.10		VWB12FECWE
150		25.50		VWB15FECWE
200	29.00	29.00	VWB20FEBWE	VWB20FEAWA
250	45.00	45.00	VWB25FEBWE	VWB25FEAWA
300	54.00	54.00	VWB30FEBWE	VWB30FEAWA
350	60.00	64.00	VWB35FEBWE	VWB35FEAWA
400	84.00	84.00	VWB40FEBWE	VWB40FEAWA
450	141.00	142.00	VWB45FEBWE	VWB45FEAWA
500	174.00	175.00	VWB50FEBWE	VWB50FEAWA
600	231.60	231.60	VWB60FEBWE	VWB60FEAWA
700	326.00	326.00	VWB70FEBWE	VWB70FEAWA
750	368.00	368.00	VWB75FEBWE	VWB75FEAWA
800	421.00	466.00	VWB80FEBWE	VWB80FEAWA
900	570.00	576.00	VWB90FEBWE	VWB90FEAWA
1000	699.00	778.00	VWC10FEBWE	VWC10FEAWA
1100	820.00	899.00	VWC11FEBWE	VWC11FEAWA
1200	1 154.00	1 154.00	VWC12FEBWE	VWC12FEAWA

- Face to face S20 according EN558-1
 - Concentric type rubber seated type
 - Comply EN 593 or EN1074-1&2
 - Basic version : Ductile iron body and disc + 150µ epoxy coating , and EPDM gasket with ACS.
- For other material, please consult us

LUG DN 40-600 PN 16 for industrial solutions



Lug with handlever

Lug with gearbox

DN	PN	HANDLEVER disc			GEARBOX WITH HANDWHEEL disc		
		weight (kg)	DI + epoxy reference	stainless steel reference	weight (kg)	DI + epoxy reference	stainless steel reference
40	10/16	2.4	VLA40FLCWE	VLA40ALCWE	3.2	VLA40FBCWE	VLA40ABCWE
50	10/16	3.3	VLA50FLCWE	VLA50ALCWE	4.1	VLA50FBCWE	VLA50ABCWE
65	10/16	3.7	VLA65FLCWE	VLA65ALCWE	4.5	VLA65FBCWE	VLA65ABCWE
80	10/16	5.2	VLA80FLCWE	VLA80ALCWE	5.9	VLA80FBCWE	VLA80ABCWE
100	10/16	6.8	VLB10FLCWE	VLB10ALCWE	7.6	VLB10FBCWE	VLB10ABCWE
125	10/16	10.3	VLB12FLCWE	VLB12ALCWE	11.2	VLB12FBCWE	VLB12ABCWE
150	10/16	10.9	VLB15FLCWE	VLB15ALCWE	12	VLB15FBCWE	VLB15ABCWE
200	16	14.5	VLB20FLAWE	VLB20ALAWA	16.5	VLB20FBAWE	VLB20ABAWE
250	16	28.2	VLB25FLAWE	VLB25ALAWA	30	VLB25FBAWE	VLB25ABAWE
300	16	41.2	VLB30FLAWE	VLB30ALAWA	43	VLB30FBAWE	VLB30ABAWE
350	16	Please contact us			59.6	VLB35FBAWE	VLB35ABAWE
400	16				83.6	VLB40FBAWE	VLB40ABAWE
450	16				122	VLB45FBAWE	VLB45ABAWE
500	16				167	VLB50FBAWE	VLB50ABAWE
600	16				250	VLB60FBAWE	VLB60ABAWE
700	16				367	VLB70FBAWE	VLB70ABAWE
800	16				482	VLB80FBAWE	VLB80ABAWE
1000	16				744	VLC10ABAWE	VLC10ABAWE

Consult us for PN10.

For flanged butterfly valves short pattern: consult us.

For others materials and coatings for body, disc, elastomer: consult us.

No flanged joint must be installed on this valve.



RAP LUG DN 40 - 1000 motorised AUMA three-phase



Lug motorised electric AUMA

DN	weight (kg)		reference	
	PN10 / PFA 10	PN16 / PFA 16	PN10 / PFA 10	PN16 / PFA 16
40		10.30		VLA40FECWE
50		11.20		VLA50FECWE
60		11.60		VLA60FECWE
65		11.60		VLA65FECWE
80		13.10		VLA80FECWE
100		14.60		VLB10FECWE
125		28.80		VLB12FECWE
150		29.50		VLB15FECWE
200	32.90	31.90	VLB20FEBWE	VLB20FEAWE
250	51.60	50.60	VLB25FEBWE	VLB25FEAWE
300	64.50	63.50	VLB30FEBWE	VLB30FEAWE
350	81.00	84.00	VLB35FEBWE	VLB35FEAWE
400	102.60	101.60	VLB40FEBWE	VLB40FEAWE
450	170.00	164.00	VLB45FEBWE	VLB45FEAWE
500	216.00	210.00	VLB50FEBWE	VLB50FEAWE
600	291.00	276.00	VLB60FEBWE	VLB60FEAWE
700	376.00	361.00	VLB70FEBWE	VLB70FEAWE
800	491.00	521.00	VLB80FEBWE	VLB80FEAWE
1000	798.00	862.00	VLC10FEBWE	VLC10FEAWE

For flanged butterfly valves short pattern: consult us

For others materials and coatings for body, disc, elastomer: consult us

For actioner electric Auma single-phase, Bernard or pneumatic, consult us.

No flanged joint must be installed on this valve

Double flanged concentric butterfly valves short pattern with joint/elastomer in body.

Face to face ISO EN 558-1 Serie 20 and Serie 13

- Standard construction :

Body in ductile iron GGS-40 and epoxy powder 150 microns, EPDM elastomer with ACS.

Disc/butterfly ductile iron GGS-40

- According to EN 1074-1 and 2, with 2500 cycles endurance test

- Other material and options on demand, consult dedicated catalogue about concentric butterfly valve range.



RAP double flanges (S20) DN150-1200 manual

DN	PN	Lever control		Handwh. reducer	
		reference	weight kg	reference	weight kg
150	10/16	VBB15FLCWE	11.5	VBB15FBCWE	12.5
200	16	VBB20FUAWE	21.7	VBB20FBAWE	23.70
250	16	VBB25FUAWE	33.7	VBB25FBAWE	35.50
300	16	VBB30FUAWE	49.7	VBB30FBAWE	51.50
350	16			VBB35FBAWE	60.00
400	16			VBB40FBAWE	92.00
450	16			VBB45FBAWE	127.00
500	16			VBB50FBAWE	163.00
600	16			VBB60FBAWE	258.00
700	16			VBB70FBAWE	357,80
750	16	Please contact us			
800	16			VBB75FBAWE	413.00
900	16			VBB80FBAWE	489.60
1000	16			VBB90FBAWE	665.00
1100	16			VBC10FBAWE	783.00
1200	16			VBC11FBAWE	1 070.60
				VBC12FBAWE	1 260.00

For PN 10, replace A by B (position 10)

RAP double flanges (S13) DN40-1000 manual



DN	PN	Lever control		Handwh. reducer	
		reference	weight kg	reference	weight kg
40	10/16	TBA40FLCWV	7.7	TBA40FBCWV	8.5
50	10/16	TBA50FLCWV	8.8	TBA50FBCWV	9.6
65	10/16	TBA65FLCWV	9.9	TBA65FBCWV	10.7
80	10/16	TBA80FLCWV	10.2	TBA80FBCWV	11.9
100	10/16	TBB10FLCWV	13.6	TBB10FBCWV	14.3
125	10/16	TBB12FLCWV	19,2	TBB12FBCWV	20.1
150	10/16	TBB15FLCWV	21.3	TBB15FBCWV	22.2
200	16	-	-	TBB20FBAWV	36.0
250	16	-	-	TBB25FBAWV	52.3
300	16	-	-	TBB30FBAWV	75.4
350	16			TBB35FBAWV	96.9
400	16			TBB40FBAWV	130.9
450	16			TBB45FBAWV	191.0
500	16			TBB50FBAWV	225.4
600	16			TBB60FBAWV	345.5
700	16	Please contact us			
750	16			TBB70FBAWV	489.3
800	16			TBB75FBAWV	526.0
900	16			TBB80FBAWV	635.6
1000	16			TBB90FBAWV	893.0
				TBC10FBAWV	1 039.0

For PN 10, replace A by B (position 10)

The air valves protect the main :

- The device evacuates great air amounts during the filling of the main,
- Allows the inlet of great air amounts (in order to avoid a vacuum effect) during the emptying of the main,
- Evacuates small air amounts that are accumulated in the high points of the main during normal working conditions.



110

111



112

113

Mini Single Function air valves Type 100 PFA 10-16-25

The Type 100 Single function air valve is designed to evacuate small air amount due mainly to desgazing effects that are accumulated on high points of the network during normal conditions

Type	Connection	weight (kg)	PFA 10-16 reference	PFA 25 reference
110	3/4"	4.5	RCF07AEAH	RCF07AEDH
	1"	4.6	RCF10AEAH	RCF10AEDH
111	3/4"	5.1	RCF07BAAH	RCF07BNDH
	1"	5.1	RCF10BNAH	RCF10BNDH
112	Flange without isolating valve	7.6	RCA40AFAH (*)	RCA40AFDH (**)
113	Flange with isolating valve	8.2	RCA40BTXH (*)	RCA40BTCH (**)

(*) Multi-drilling flange DN 40-50-60-65 PN 10-16.

(** *) Multi-drilling flange DN 40-50-60-65 PN 10-16-25.

Double function air valves type "S" DN 50-60/65-80 PFA 10-16-25

Single large orifice: the device evacuates great air amounts during the filling of the piping or allows the inlet of great air amounts (in order to avoid a vacuum effect) during the emptying of the piping such air valve can be placed in front of isolating valves.



Type	DN	PN flange	weight (kg)	reference
4000 S	50	10 - 16 - 25	9	203930
	60-65	10/16		203930
	60-65	25		203938
6000 S	80	10 - 16 - 25	20	203946

Triple function air valves type "D" without isolating valve PFA 10-16-25

Triple function air valves (double orifice) are designed to act during pipe filling, pipe emptying (large orifice) and also for venting function (small orifice), they can be placed in the network on both high points or in front of isolating valves



Type	Flanges (DN)	weight (kg)	PFA 10/16 reference	PFA 25 reference
4000	50	15	RCA50DSDH	RCA50DSDH
	50 - 60 - 65	15	RCA60DSAHA	-
	60 - 65	15	-	RCA60DSDH
6000	80	25	RCA80DSAHA	RCA80DSDH
9000	100	38	RCB10DSAHA	RCB10DSDH
	150	42	RCB15DSAHA	RCB15DSDH

Flanges in accordance with Standard ISO 7005.



Triple function air valves type "Ventex®" high flow rate with isolating valve PFA 10-16-25 bar

Air Valves Type VENTEX® exist in a range stretching from DN 50 to 200, for pressure PFA 10, PFA 16 and PFA 25. Equipped with a built-in isolating valve.
FAST CHOICE OF A VENTEX®: allows during the emptying of the main with a speed 1m/s.

Main	DN ≤ 250	DN 300-600	DN 700-900	DN 1000-1200	DN 1200-1800
Air valve	DN 50,60,65	DN 80,100	DN 150	DN 200	2x DN 200

standard version

DN	weight (kg) cap version	reference					
		PFA 10		PFA 16		PFA 25	
		handwheel	cap	handwheel	cap	handwheel	cap
50	22	RCA50CSBHV	RCA50CSBH	RCA50CSAHV	RCA50CSAH	RCA50CSDHV	RCA50CSDH
60	24	RCA60CSBHV	RCA60CABH	RCA60CSAHV	RCA60CAAH	RCA60CSDHV	RCA60CADH
65	24	RCA65CSBHV	RCA65CSBH	RCA65CSAHV	RCA65CSAH	RCA65CSDHV	RCA65CSDH
80	40	RCA80CSBHV	RCA80CABH	RCA80CSAHV	RCA80CAAH	RCA80CSDHV	RCA80CADH
100	40	RCB10CSBHV	RCB10CABH	RCB10CSAHV	RCB10CAAH	RCB10CSDHV	RCB10CADH
150	115	RCB15CSBHV	RCB15CABH	RCB15CSAHV	RCB15CAAH	RCB15CSDHV	RCB15CADH
200	170	RCB20CSBHV	RCB20CABH	RCB20CSAHV	RCB20CAAH	RCB20CSDHV	RCB20CADH

Reinforced version – please consult us

Ventex® air valve without isolating valve

DN	weight (kg)	reference		
		PFA 10	PFA 16	PFA 25
50	24	RCA50VSBH	RCA50VSAH	RCA50VSDH
60	24	RCA60VABH	RCA60VAAH	RCA60VADH
65	24	RCA65VSBH	RCA65VSAH	RCA65VSDH
80	38	RCA80VABH	RCA80VAAH	RCA80VADH
100	38	RCB10VABH	RCB10VAAH	RCB10VADH
150	99	RCB15VABH	RCB15VAAH	RCB15VADH
200	154	RCB20VABH	RCB20VAAH	RCB20VADH

Reinforced version – please consult us



Triple function air valves PURGEX 60 - high flow rate PFA10 - 16 - 25 bar

Equipped with a built-in isolating valve.

Standard (large orifice nozzle)

PURGEX DN 60 protect mains DN 60 up to 200.

The device evacuates great air amount during the filling of the main. Allows the inlet of great air amounts (in order to avoid a vacuum effect) during the emptying of the main.

Standard and reinforced version

For pipes DN 60 up to 350.

Evacuates small air amounts that are accumulated in the high points of the main during normal working conditions.

standard version	weight (kg)	PFA 10 / 16		PFA 25	
		weight (kg)	reference	weight (kg)	reference
flange DN 60	10.6		RCA60BUCH	10.6	RCA60BUDH
flange DN 65	10.6		RCA65BUCH	10.6	RCA65BUDH

Reinforced version please, consult us.

Pressure regulating valve

The automatic control valve is designed to operate using the hydraulic pressure of the network.

Such valves are equipped with pilots that enable to react to different parameters by adjusting the opening of the valve automatically : differents basics versions are presented here :

- Pressure reducing valve (to limit pressure rating downstream)
- Pressure sustaining valve (to maintain a minimum pressure rate upstream)

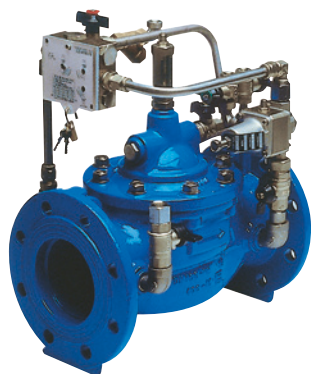

DN	weight (kg)	pressure reducer E 2115-00 pressure range 1.4/12 bar	pressure sustainer E 2116-00 pressure range 1.4/14 bar	pressure reducer/sustainer E 2115-02 pressure range 1.4/12 bar
		reference	reference	reference
50	20	RCA50DBCHA	RCA50DCCHB	RCA50DDBHE
65	23	RCA65DBCHA	RCA65DCBHB	RCA65DDBHE
80	25	RCA80DBCHA	RCA80DCBHB	RCA80DDBHE
100	36	RCB10DBCHA	RCB10DCCHB	RCB10DDCHE
125	51	RCB12DBCHA	RCB12DCCHB	RCB12DDCHE
150	62	RCB15DBCHA	RCB15DCCHB	RCB15DDCHE
200*	110	RCB20DBBHA	RCB20DCBHB	RCB20DDBHE
250*	191	RCB25DBBHA	RCB25DCBHB	RCB25DDBHE
300*	320	RCB30DBBHA	RCB30DCBHB	RCB30DDBHE
400*	603	RCB40DBBHA	RCB40DCBHB	RCB40DDBHE
500*	935	RCB50DBBHA	RCB50DCBHB	RCB50DDBHE
600*	1280	RCB60DBBHA	RCB60DCBHB	RCB60DDBHE
700*	2148	RCB70DBBHA	RCB70DCBHB	RCB70DDBHE

Note: References for DN > 150: flanges drilled DN 10. Please consult us for PN25.

* For PN 16, change (B) for (A) in 8 position of reference.

Flow regulating valve E2114-00



DN	weight (kg)		reference	
	PN10	PN16	PN10	PN16
50		26		RCA50DMCH
65		29		RCA65DMBH
80		31		RCA80DMBH
100		48		RCB10DMCH
125		61		RCB12DMCH
150		72		RCB15DMCH
200	120	115	RCB20DMCH	Consult us
250	201	201	RCB25DMBH	RCB25DMAH
300	330	420	RCB30DMBH	Consult us
400	618	620	RCB40DMBH	Consult us
500	935	870	RCB50DMBH	Consult us
600	1280	1280	RCB60DMBH	Consult us
700	2148	2040	RCB70DMBH	Consult us

Please consult us for PN25.

Level control valve



Altitude model

DN	weight (kg)	float-controlled on-off valve E2110-14	altitude on-off valve E2127-01 3 to 20 m*
		reference (PN 10)	reference (PN 10)
50	20	RCA50DFBH-E01	RCA50DGBH
65	23	RCA65DFBH-E01	RCA65DGBH
80	25	RCA80DFBH-E01	RCA80DGBH
100	36	RCB10DFBH-E01	RCB10DGBH
125	51	RCB12DFBH-E01	RCB12DGBH
150	62	RCB15DFBH-E01	RCB15DGBH
200	118	RCB20DFBH-E01	RCB20DGBH
250	191	RCB25DFBH-E01	RCB25DGBH
300	320	RCB30DFBH-E01	RCB30DGBH
400	603	RCB40DFBH-E01	RCB40DGBH
500	935	RCB50DFBH-E01	RCB50DGBH
600	1280	RCB60DFBH-E01	RCB60DGBH
700	2148	RCB70DFBH-E01	RCB70DGBH

For PN 16 and 25, please consult us.

* 1-6 m and 15-65 m : please consult us.



Electrically operated on/off valve.
Tension 24V 50Hz
Normally closed not under tension.

Electric operated on-off valve

DN	On / Off duty	
	normally open or normally closed (normally open speed controls) weight (kg)	reference*
E 2113 - 12		
50	20	RCA50DHBH*
65	23	RCA65DHBH*
80	25	RCA80DHBH*
100	36	RCB10DHBH*
125	51	RCB12DHBH*
150	62	RCB15DHBH*
E 2113 - 06		
200	118	RCB20DHBH*
250	191	RCB25DHBH*
300	320	RCB30DHBH*
400	603	RCB40DHBH*
500	935	RCB50DHBH*
600	1280	RCB60DHBH*
700	2148	163099*

*Standard reference, consult us for define a voltage. Electrically operated. Normally closed not under tension.
For control valves "step by step" 24V 50Hz, consult us. Consult us for PN16 and 25.



DRVD - Spring operated pressure reducing valve PFA 16 bar

DN	weight (kg)	reference
50	18	165834
65	24	165872
80	38	165911
100	58	166907
125	78	165986

Nota: pressure standard version: 1.5-6 bar. For higher pressure, please consult us



Manual and Motorized needle valves - E508

The main characteristic of needle valve is the capacity to modulate water flow rate and elevated differential pressure. The needle valve NGL is able to do a linear manoeuvre also in a presence of relevant partialization degree although high inlet pressure and big exercise difference of pressure. The possibility to be actuated by electrical devices permit to use this valve in combination with control system to realize multiple function.

The internal profile of the valve is designed to optimize the hydrodynamic profile in order to have:

- low head losses whit valve completely open
- minimize cavitation phenomena in case of big differences between inlet and outlet pressures of valve. In this case the valve can be equipped with a special stainless steel cylinder for hydraulic loads dissipation

Range :

- Manual or motorized (with handwheel)
- DN100 to 1000
- PN 10-16-25-40
- With or without anti-cavitation cylinder

EUROSTOP® safety butterfly valves

Safety butterfly valves are designed to prevent from damages or tank emptying due to pipebreak event on water network by shutting, it can also be used on hydropower installations.

The valve closes automatically when an overflow is detected.

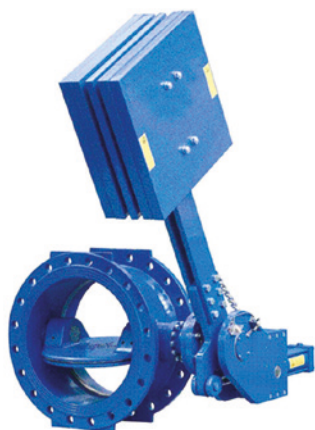

DN	PN 10		PN 16		PN 25	
	weight (kg)	reference	weight (kg)	reference	weight (kg)	reference
150	237	511-0150/16-B	237	511-0150/16-B		511-0150/25-B
200	250	511-0200/10-B	250	511-0200/16-B	265	511-0200/25-B
250	273	511-0250/10-B		511-0250/16-B		511-0250/25-B
300	293	511-0300/10-B	407	511-0300/16-B	440	511-0300/25-B
350	429	511-0350/10-B		511-0350/16-B		511-0350/25-B
400	463	511-0400/10-B	650	511-0400/16-B	679	511-0400/25-B
450	650	511-0450/10-B	690	511-0450/16-B		511-0450/25-B
500	679	511-0500/10-B	729	511-0500/16-B	993	511-0500/25-B
600	948	511-0600/10-B	1030	511-0600/16-B	1577	511-0600/25-B
700	1103	511-0700/10-B	1616	511-0700/16-B	2588	511-0700/25-B
800	1721	511-0800/10-B	2657	511-0800/16-B		511-0800/25-B
900	1917	511-0900/10-B	2828	511-0900/16-B	4196	511-0900/25-B
1000	3037	511-1000/10-B	3187	511-1000/16-B		511-1000/25-B
1200	3478	511-1200/10-B	4937	511-1200/16-B		511-1200/25-B
1400	5092	511-1400/10-B	7358	511-1400/16-B	9158	511-1400/25-B

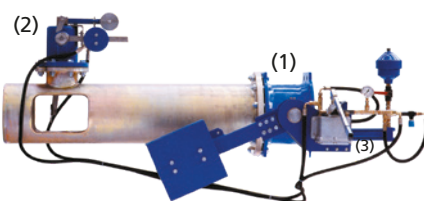

For DN > 1400, please consult us.

Safety butterfly valves composed of:

- (1) EUROSTOP® with counterweight
- (2) Paddle over speed detector
- (3) Manual resetting pump

Also available on demand : Control unit for remote resetting

Consult us for reinforced version and to ensure a type of roll cavitation

Pressure relief valve

Pressure relief valve is designed to open during a waterhammer wave in the pipeline, its effect is to reduce the magnitude of the wave and prevent from damages on the pipeline during transient event



DN	PFA 16, pressure range: 6 to 12 bar		PFA 25, pressure range: 16 to 25 bar	
	weight (kg)	reference*	weight (kg)	reference**
60	34	161866	34	161850
65	34	161853	34	161852
80	38	167046	38	161854
100	42	161872	42	167066
125	54	161856	54	167077
150	78	167093	78	167091
200	88	167105	88	161875

* Flanges drilled PN 10/16, except DN 200 drilled PN 10

** Flanges drilled PN 25

Note: for other flange drillings or pressure ranges, contact us.

Manometer



pression	reference
0 - 10	202458
0 - 16	202297
0 - 25	202298



Swing check valve PFA 10 / 16 bar

Swing check valves for Non return function

DN	weight (kg) (PN10 and 16)	reference	
		PN10	PN16
40	11		RCA40FACHM
50	14		RCA50FACHM
65(1)	17		RCA65FACHM
80	21		RCA80FACHM
100	29		RCB10FACHM
125	42		RCB12FACHM
150	60		RCB15FACHM
200	92	RCB20FABHM	RCB20FAAHM
250	145	RCB25FABHM	RCB25FAAHM
300	175	RCB30FABHM	RCB30FAAHM
350	300	RCB35FABHM	RCB35FAAHM
400	395	RCB40FABHM	RCB40FAAHM
500	613	RCB50FABHM	RCB50FAAHM

(1) Flange drilling DN 60, for DN 65, please, consult us.



DN 40 to 300



DN 350 to 700

Y Strainer PFA 10 / 16 and 25 bar

Design to protect equipment from debris

DN	weight (kg)			reference		
	PN10	PN16	PN25	PN10	PN16	PN25
40		6.5	8		RCA40QACHL	167026
50		8.5	13		RCA50QACHL	161845
65		12	18		RCA65QACHL	167034
80		17	25		RCA80QACHL	169859
100		25	36		RCB10QACHL	161848
125		39	57		RCB12QACHL	182511
150		61	80		RCB15QACHL	167087
200	106	109	140	RCB20QABHL	RCB20QAAHL	167097
250	125	162	215	RCB25QABHL	RCB25QAAHL	167113
300	171	280	300	RCB30QABHL	RCB30QAAHL	167122
350	203	234		RCB35QABHL	RCB35QAAHL	
400	275	313		RCB40QABHL	RCB40QAAHL	
450	341	393		RCB45QABHL	RCB45QAAHL	
500	400	475		RCB50QABHL	RCB50QAAHL	
600	541	711		RCB60QABHL	RCB60QAAHL	
700	774	912		RCB70QABHL	RCB70QAAHL	

DN > 150 flange drilling.

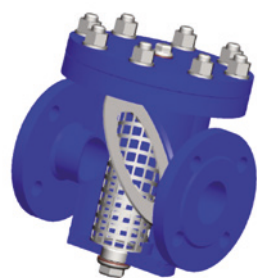

Strainer type "T" PFA16 et 25 bar

DN	weight (kg)	reference		
		PN10	PN16	PN25
50	28		216296	216328
65	30.3		216297	216329
80	39.4		216298	216330
100	42.4		215584	216331
125	67.2		216299	216332
150	72.6		216300	216333
200	142	216302	216310	216334
250	232.4	216303	216321	216335
300	305.8	216304	216322	216336
350	534.3	216305	216323	216337
400	586.8	216307	216324	216339
450	921.1	216308	216326	216340
500	989.8	216309	216327	216351



Foot check valves with strainer PFA 10 bar

DN	weight (kg)	reference
65	11	RCA65NABH
80	17	RCA80NABH
100	20	RCB10NABH
125	28	RCB12NABH
150	35	RCB15NABH
200	60	RCB20NABH
250	89	RCB25NABH
300	128	RCB30NABH
> 300	please, consult us	

Note: References for flanges PN 10.
On DN ≤ 150 the flanges are drilled PN 10/16.

Level Float valves PFA 10 bar

Constant level tank filling, from top, also available from tank bottom



DN	top of reservoir		base of reservoir	
	weight (kg)	reference	weight (kg)	reference
60	25	162918	25	167300
65	25	162919	25	171923
80	30	162921	30	167304
100	35	162923	35	167313
125	50	162913	50	167315
150	60	162924	60	171924
200	70	162914	70	167326
250	85	162925	85	171927
300	97	162926	97	162916

Cast iron covers

Tank access covers with or without venting chimney

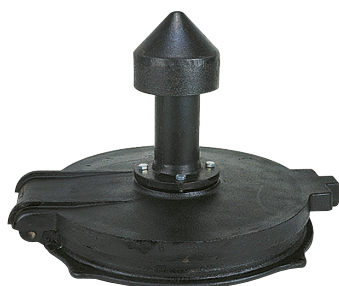

DN	with venting		without venting	
	weight (kg)	reference	weight (kg)	reference
600	132	161738	111	161749

	weight (kg)	reference
Operating key	0.5	161750
Cover with bolts	1	184087
Ventilation chimney	18	161751

A complete range of parts for the installation of pillar-type and underground fire hydrants.



QUICK GS simple or anchored version



QUICK PVC simple or anchored version

Fire protection range

On www.pamline.com, access to fitting instructions and spare parts data sheets for the whole range of Saint-Gobain PAM Canalisation pillar hydrants.

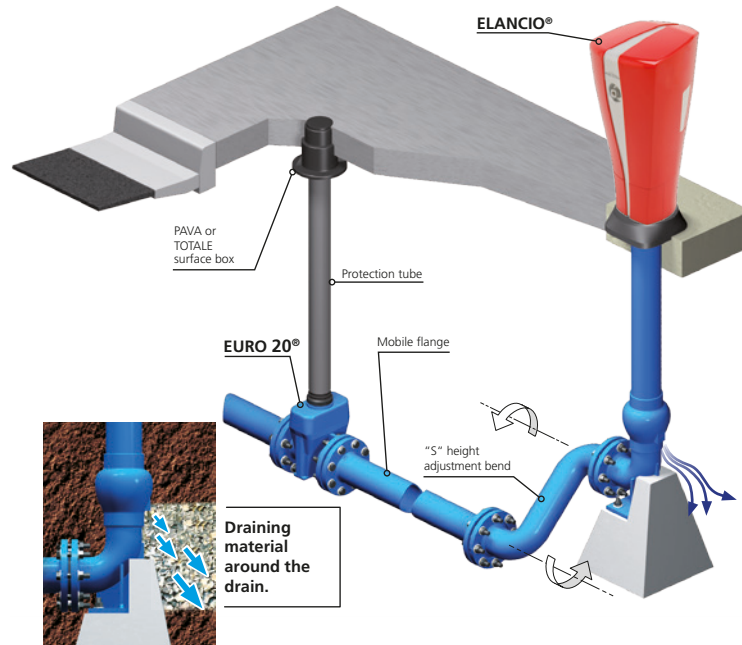

Street furniture with a seductive design

- To house new fire hydrants and to harmoniously renovate your existing stock while retaining the old fire hydrants.
- Fire hydrant casing with soft and refined lines; ELANCIO adds a touch of modernity to a town
- Central section metal grey in colour; this highlights its slim silhouette and contemporary appearance.

A good protection in case of emergency

- Wide opening doors for rapid access to the water access couplings and easy maneuverability of the fire hydrant.
- Dominant red colour for guaranteed visibility during the day and reflective strips to allow easy identification for emergency nighttime operations.
- After intervention, door closure with a single gesture.



ELANCIO® Pillar Hydrants DN 80 and DN 100 PFA 16

Conformity by standards EN14384.

Standard version with symmetric outlets, other outlets types on demand.



ELANCIO® cover

traffic version with adjustment module

DN	Hc = 1 m		Hc = 1.25 m	
	weight (kg)	reference	weight (kg)	reference
80*	115	RYA80KBBAC	130	RYA80KPCAC
100	117	RYB10KBBCC	136	RYB10KPCCC

non-traffic version without adjustment module

DN	Hc = 1 m		Hc = 1.25 m	
	weight (kg)	reference	weight (kg)	reference
80*	83	RYA80KEBAC	103	RYA80KVCAC
100	87	RYB10KEBCC	110	RYB10KVCCC

* One outlet connection version, ELANCIO® DN 80 with 3 outlets connections on demand.

Weight values are approximate. Real value varies according to the type of connection.

On demand: other type of outlet

Valve box with integral bend or straight valve box with duck foot bend.

ELANCIO® protection hood to renovate old pillar hydrants



kit number	pillar hydrants type	weight (kg)	reference
N° 1	Hydro DN 80 NR 1969-1982	12	212794
	AJAX® DN 80 1969-1982		
	ELANCIO® DN 80 and DN 100 2008 NR and VR		
N° 2	Tri DN 80 NR 1969-1982	12.2	212795
	Atlas DN 80 NR and VR 1982-2003 ELANCIO® DN 80 and DN 100 2008 VR and VA		
N° 3	HERMES DN 80 NR and VR 1982-2003	12.2	212796
	AJAX® DN 80 NR and VR 1982-2003		
	HERMES + DN 80 NR and VR 2003-2008		
	HERMES + DN 100 NR and VR 2003-2008		
	AJAX® + DN 80 NR and VR 2003-2008 AJAX® + DN 100 NR and VR 2003-2008		
N° 4	Hydro DN 100 NR 1969-1982	12	212790
	AJAX® DN 100 NR 1969-1982		
N° 5	Tri DN 100 NR 1969-1982	13.3	212812
	Atlas DN 100 NR and VR 1982-2003		
N° 6	HERMES DN 100 NR and VR 1982-2003	14.7	212813
	AJAX® DN 100 NR and VR 1982-2003		
N° 7	PH GHM NR DN 100, types C9A, C9P and C9M 1995-2000 PH VR DN 80 and 100, types IMPACT A, P and M from 1995 to 2000	12	216602
N° 8	PH Atlas+ DN 100 VR and NR beginning from 2003	12.8	217478
Hub cap	Valid for all the versions	0.9	215586
Collar DN118	For fire protection kits N° 1, 2 and 3	2.0	223505
Collar DN144	For fire protection kits N° 4, 5 and 6	2.0	223506

ATLAS+ pillar hydrants PFA 16 bar

Standard construction with symmetric outlets



ATLAS Plus DN 100 traffic version.

non-traffic version without adjustment module

DN	Hc = 1 m		Hc = 12.5 m	
	weight (kg)	reference	weight (kg)	reference
80*	81	RYA80FEBAC	103	RYA80FVCAC
100	83	164250	105	164252

traffic version with adjustment module

DN	Hc = 1 m		Hc = 1.25 m	
	weight (kg)	reference	weight (kg)	reference
80*	105	RYA80FBBAC	127	RYA80FPCAC
100	107	164249	129	164251
150	170	RYB15ABBDC	170	RYB15APCDC

Straight valve box with or without duck foot bend, on demand.

Straight valve box for hydrant DN 150.

* One outlet connection version Atlas plus, DN 80 with 3 outlets connections on demand.

C9+ pillar hydrants DN 80 & DN 100 PFA 16 bar

non-traffic version without adjustment module



BS 336 DN 2' 5 DN 4'

DN	outlet	Hc = 1 m BC = bend valve box		Hc = 1.25 m BD = straight valve box	
		weight (kg)	reference	weight (kg)	reference
80	3 symmetric	71	RYA80DEBBC	91	RYA80DVCBC
	1 symmetric	71	RYA80DEBAC	91	RYA80DVCAC
	3 storz	70	Please, consult us	—	—
100	3 symmetric	75	RYB10DEBCC	98	please, consult us
	3 storz	68	182220		
	3 BS	72	164245		
	3 NFPA*	68	RYB10DEBWF		

Short version Hc = 0.8 m, DN100 Non-traffic version without adjustment module, reference = 171528.

*NFPA outlet version without CE marking.

traffic version with adjustment module



STORZ DN 2 DN 2' 5 DN 4'

DN	outlet	Hc = 1 m BC = bend valve box		Hc = 1.25 m BD = straight valve box	
		weight (kg)	reference	weight (kg)	reference
80	3 symmetric	84	RYA80DCBBC	91	RYA80DVCBC
	1 symmetric	84	RYA80DCBAC	91	RYA80DVCAC
	1 symmetric *	80	RYA80DQBAC	—	—
	3 storz	78	RYA80DCBJB	—	—
	1 storz	78	206082	—	—
100	3 symmetric	86	RYB10DGBFC	105	RYB19DQCCC
	3 storz (*,*)	(*,*)	(*,*)	101	175991
	3 BS	80	182101	101	please, consult us
	3 NFPA***	80	184814	—	—

(*) BD = straight valve box.

(*,*) 3 types outlet: 1x2"1/2 and 2x2", 1x4" and 2x2"1/2, 1x4 and 1x2"1/2 and 1/2".

Hc=1,5 m. outlet 3 storz, reference = 207230.

*** NFPA outlet version without CE marking.

AWWA DN 2' 5 DN 4' 5

For other covering depths (Hc) and for other outlet connections (NF, UNI, UNE, NBN, AWWA...) please, consult us.

Available with or without surface box and with or without duck foot bend.

Available with other connections (NF, UNI, UNE, NBN, AWWA,...).

Available with outlet connections complying with standards NF, NBN, UNI, UNE, AWWA, STORZ, GOST, BS.

Weight of DN 80 with duck foot bend, depth of cover 1 m: 48.5 kg.

Weight of DN 100 with duck foot bend, depth of cover 1 m: 57.5 kg.

Weight of the surface box: 28.5 kg.



UNI DN 70 DN 100



UNE DN 2' 5 Bomberos DN 4'



TANGO® Pillar Hydrants DN 100 PFA 16



ALL TYPE OF OUTLET

HIGH QUALITY CORROSION PROTECTION AS STANDARD DESIGN

Internal : Epoxy 250
External : Epoxy 250 + Polyurethane UV resistant

TRAFFIC OR NON TRAFFIC
Possibility to change from one to the other onsite

STANDARD

- EN14384
- CE MARKING

TECHNOLOGIE

- TORQUE RESISTANCE UP TO 80 Nm
- PFA 16 bar
- Kv > 160 m3/h

All in on valve :

- Open / Close : 13 turn
- Progressive flow
- Automatic & reliable hydrant emptying design

AVAILABLE IN STOCK

- SYMETRIQUE HC 1m

ON DEMAND

- OTHER DEPTH OF COVER
- BOMBEROS / UNE
- UNI
- STORZ
- BS336



RATIONNEL+ DN 100 PFA 16 bar



DN 100

TRAFFIC OR NON TRAFFIC
PFA 16 bar
KV > 160 m3/h
Nb turn : 13

Standard Version :
Symetric outlet, type of cover 1m

ON DEMAND

Other depth of cover
Other outlet :
- BOMBEROS / UNE
- UNI
- STORZ
- BS336

BI 97 - Underground fire hydrant DN 100 PFA 16 bar

Fully epoxy coated underground fire hydrants with independent surface box



DN	type	outlet	weight (kg)	reference
100	PAM	Keyser Ø 100	83.6	RHB10AABGJ

For other covering depths (Hc) please, consult us.

Available with or without surface box and with or without duck foot bend.

Available with other connections (NF, UNI, UNE, NBN, AWWA...).

Available with outlet connections complying with standards NF, NBN, UNI, UNE, AWWA, STORZ, GOST, BS.

Weight of DN 80 with duck foot bend, depth of cover 1 m: 48.5 kg.

Weight of DN 100 with duck foot bend, depth of cover 1 m: 57.5 kg.

Weight of the surface box: 28.5 kg.

FH2 - Underground fire hydrant BS 750 type 2 PFA 16 bar

Fully epoxy coated underground fire hydrants. Frost valve include.



type	outlet	weight (kg)	reference
UK version			
fixed	London round thread (S.S.)	49.9	230707
	Standard outlet with screwed connection (brass)	14.4	—
	UK bayonet outlet (C.I.)	21.5	214349
loose	London round thread (S.S.)	14.2	230709
	Standard brass outlet with screwed connection (brass)	14.4	—
	UK bayonet outlet (C.I.)	21.5	—

PAM heavy duty version

fixed up-graded	London round thread (S.S.)	14.2	214476
fixed heavy duty	London round thread (S.S.)	14.2	214357
loose up-graded	London round thread (S.S.)	14.2	214479
loose heavy duty	London round thread (S.S.)	14.2	214481

PAM standard building version

fixed	Nigerian outlet (C.I.)	18	214482
	Da Costa/Barbados outlet (C.I.)	19	214466
loose	Nigerian outlet (C.I.)	18	214467
	Da Costa/Barbados outlet (C.I.)	19	214468

Reinforced construction or other outlet connections: please, consult us.

Spare parts for fire protection and underground fire hydrant.

Ask our « spare parts and Underground fire hydrant » ask regional agencies.



Easy and fast search of spare parts

1.- Choice type PI



2.- Choice of the part to be repaired, definition of n° datasheet

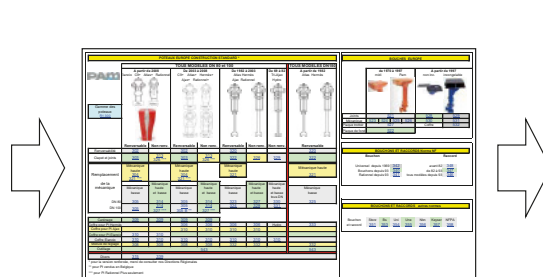

3.- Datasheet, contents of the kit

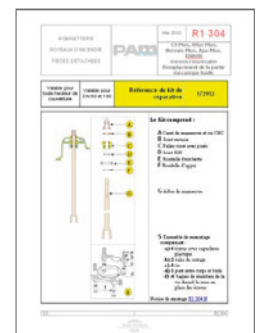



Testing flowmeters for pillar and underground fire hydrants

Designation	weight (kg)	reference
Flowmeter Oreo epoxy DB100A	6.5	224992
Flowmeter Oreo epoxy DB100AL	11.5	224993



Accessories flowmeters for pillar and underground fire hydrants

Designation	weight (kg)	reference
1 Case for DB100-A	4.2	224994
2 Case for DB100-AL	6	225014
3 Lenticular valves with 2 connecting pieces DN100 RAC ALU DN100	6.3	224996
4 Pipe 5 M with 2 aluminium valves DN100	8.5	224997
5 Ground support with fire connecting piece	4.1	224998
6 Diffusor for flowmeter	6.2	225015
7 Aluminium plug DN100 with locking system	0.5	225000

Repair kits for traffic version pillar-type fire hydrant

DN	Designation	weight (kg)	reference
80*	(Atlas, HERMES, AJAX®)	4.5	172939
100*	(Atlas, HERMES, AJAX®, Rationnel)	4.5	162325
100*	(Atlas+, HERMES+, AJAX®+, Rationnel+, ELANCIO®, C9+)	4.5	172939
150**	(Atlas, HERMES)	2.5	162344

* Pack with 3 kits ** Pack with 1 kit
1 kit is composed of 1 set of breakable fuses, 1 joint and screws.

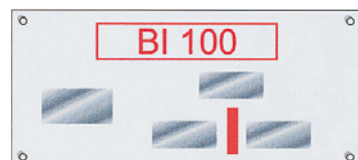

Fire hydrant location sign

reference	weight (kg)
162288	0.1

Fitting extension "KEYSER" for underground



Type	weight (kg)	reference
H = 35 mm	1.4	162342
H = 50 mm	2	162343

Lot of 3 '35mm' height extensions for DN100 KEYSER.

"S" Height adjustment bend

DN	weight (kg)	reference
80	16	271163
100	19.5	271181
150	31.6	271182

With rotatable flange.



Operating keys for pillar-type fire hydrants

Designation	weight (kg)	reference
1 TRICOISE UNIVERSELLE for fittings DN 20 to 120	0.5	162009
2 Operating key for pillar-type fire hydrants	1	162317
3 Operating key "FÉDÉRALE" for pillar-type fire hydrants	2	162008
4 Articulated T key for surface boxes of 0.7 m	2	162097
Articulated T key for surface boxes of 1.5 m	3.5	162289

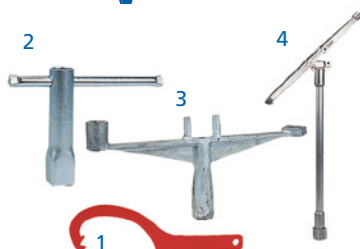

MULTITURN - VERTICAL INSTALLATION



- Complies with EN 1074-1 e 2
- Spheroidal cast iron body and cap
- Shaft and control panel in AISI 420 stainless steel.
- Brass plug, EPDM coated in accordance with EN 681-1 and suitable for contact with drinking water in accordance with Ministerial Decree 174».
- PFA 16 bar.
- Epoxy paint, 250 micron thickness
- Conical thread ISO 7/1 and cylindrical thread ISO 228/1

Reference	DN INPUT	DN OUTPUT
277920	1"	1"
270275	1" 1/4	1"
270276	1" 1/4	1" 1/4
270277	1" 1/2	1" 1/2
278359	2"	1" 1/2
270278	2"	2"

MULTITURN - HORIZONTAL INSTALLATION



Reference	PFA	DN
277668	16	3/4"
270755	16	1"
277615	16	1" 1/4
270754	16	1" 1/2
277919	16	2"

VALVE CAP QP

TYPE	Reference
CAPPELOTTO PER VALVOLE QP	270752

Ferrule cock RS



- Spheroidal cast iron body and cap.
- Square drive shaft (11 mm) and brass plug
- Epoxy paint, 250 micron thickness.
- Conical Gas male thread UNI ISO 7/1 and cylindrical Gas female thread UNI ISO 228/1

DN	1" M 1" F	1" 1/4 M 1" 1/4 F	1" 1/2 M 1" 1/2 F	2" M 2" F
Reference	RVL25GDCBA	RVL32GEDBA	RVL40GFEB A	RVL50GGFBA

Operating extension



Length	Reference
1 m	201417
1,5 m	201418

Operating extension



DN	Length	
	1M	1,5M
1"	201427	201429
1" 1/4	201433	201435
1" 1/2	201433	201435
2"	201428	201430

	Range DN	Flange joint kits	Metal reinforced gasket
	40 - 300	<p>Gasket with embedded metal</p> <ul style="list-style-type: none"> - EPDM gasket - galvanized steel bolts for flanged joints - metallic inserts - PFA 10 to 16 bar 	<p>Gasket with embedded metal</p> <ul style="list-style-type: none"> - EPDM gasket - metallic inserts
	350 - 2000		<p>Gasket with embedded metal reinforcement</p> <ul style="list-style-type: none"> - EPDM gasket - metallic inserts

Metal reinforced gasket improves lifetime and leakness for maximal pressure. According to EN 1092-2 and ISO 7005-2 standards.

Flange joint kits EPDM with metal reinforced gasket

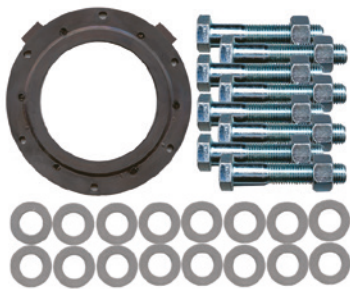

DN	PN	weight (one kit) (kg)	kit reference
40	10 to 40	0.85	JBA40KV1
60	10 and 16	0.89	JBA60KV1
80	10 to 40	1.69	JBA80KV1
100	10 and 16	1.72	JBB10KV1
125	10 and 16	1.76	JBB12KV1
150	10 and 16	3.04	JBB15KV1
200	10	3.10	JBB20KV1
200	16	4.52	JBB20KV2
250	10	4.89	JBB25KV1
250	16	7.35	JBB25KV2
300	10	5.32	JBB30KV1
300	16	8.25	JBB30KV2

Complete flange joint kit in one package.

Metal reinforced gaskets unit



DN	Reference PN10	Reference PN16	Reference PN25
40	JBA40GV1-E12	JBA40GV1-E12	JBA40GV1-E12
50	JBA50GV1-E12	JBA50GV1-E12	JBA50GV1-E12
60	JBA60GV1-E12	JBA60GV1-E12	JBA60GV1-E12
65	JBA65GV1-E12	JBA65GV1-E12	JBA65GV1-E12
80	JBA80GV1-E12	JBA80GV1-E12	JBA80GV1-E12
100	JBB10GV1-E12	JBB10GV1-E12	JBB10GV1-E00
125	JBB12GV1-E12	JBB12GV1-E12	JBB12GV1-E00
150	JBB15GV1-E12	JBB15GV1-E12	JBB15GV1-E00
200	JBB20GV1-E12	JBB20GV1-E13	JBB20GV1-E00
250	JBB25GV1-E12	JBB25GV1-E13	JBB25GV1-E00
300	JBB30GV1-E12	JBB30GV1-E13	JBB30GV1-E00
350	JBB35GV1-E12	JBB35GV1B-E13	JBB35GV1B-E00
400	JBB40GV1-E12	JBB40GV1B-E13	JBB40GV1B-E00
450	JBB45GV1-E12	JBB45GV1B-E13	JBB45GV1B-E00
500	JBB50GV1-E12	JBB50GV1B-E13	JBB50GV1B-E00
600	JBB60GV1-E12	JBB60GV1B-E13	JBB60GV1B-E00
700	JBB70GV1-E12	JBB70GV1-E13	JBB70GV1-E00
800	JBB80GV1-E12	JBB80GV1-E13	JBB80GV1-E00
900	JBB90GV1-E12	JBB90GV1-E13	JBB90GV1-E00
1000	JBC10GV1-E12	JBC10GV1-E13	JBC10GV1

- Excellent mechanical properties.
- Easy installation thanks to the locating lugs.
- The joint is leak-tight with low bolting torques.

RANGE	EXTENSION	PAVEMENT	STREET
PAVA 	Built-in extension : system screw-nut	3 versions in function of total extension 	
TOTALE 	Extension 	3 versions round hexagonal square 	3 versions round hexagonal square
EXHAUSSABLE 		3 versions round hexagonal square 	



PAVA Surface Box

Type	Total extension length (mm)	batch	weight (kg)	reference
10	105	50 *	8	F1PVAC
14	185	50 *	13	F2PVAC
19	150	25 *	23	F3PVAC

(*) Packaging 1100 x 1000.

TOTALE Surface Box

Type	batch	weight (kg)	reference
Pavement, round pattern	60 *	5	FRTOAB
Pavement, hexagonal pattern	60 *	5	FRTODB
Pavement, square pattern	60 *	5	FRTOBB
Street, round pattern	70 **	3	FTTOAB
Street, hexagonal pattern	35 **	3	FTTODB
Street, square pattern	35 **	3	FTTOBB

(*) Packaging 1100 x 1000

(**) Euro-packaging 1200 x 800

EXTENSION with cover for TOTALE Surface box

Type	batch	weight (kg)	reference
Round pattern	50 *	4	FRT063U
Hexagonal pattern	50 *	4	FRT063W
Square pattern	50 *	4	FRT063V

(*) Packaging 1100 x 800

EXTENSION Surface box

(also available for TOTALE MAXI)

Type	batch	weight (kg)	reference
Round pattern	50	7	FRRHACT
Hexagonal pattern	50	7	FRRHDCT
Square pattern	55	7	FRRHBCT

TOTALE MAXI Surface box

Type	batch	weight (kg)	reference
Round pattern	40 *	6.4	FRXBACT
Hexagonal pattern	40 *	6.5	FRXBDCCT
Square pattern	40 *	6.5	FRXBBCT

(*) Packaging 1100 x 1000

Surface box with a heavy duty cover with 3 centering gliders, opening by hook enlarged base.

HAMMER for Surface box

reference	weight (kg)
162098	2





PAM ULTRAQUICK NG
MAB10HACHD
TYPE D DN 100 PN10/16
PFA 16 OD/DE 97/127
BOLT TORQUE
M12 COUPLE DE SERRAGE 60-70 Nm

■ Flange adaptors.....	34	■ Dismantling joints.....	43
UltraQUICK.....	34	Large stroke standard	43
QUICK PVC.....	35	Large stroke with free flange.....	43
QUICK PE.....	35	■ Tapping collars.....	44
QUICK GS	35	Gaz threaded type MGD.....	44
■ Couplings.....	37	Gaz threaded type Manicotto for PVC/PE/PIPE.....	47
UltraLINK wide tolerance	37	Gaz threaded type MPE	48
LINK GS	37		
LINK PE/PVC anchored	38		
FIXLINK PE/PVC.....	39		
FIXLINK GS.....	39		
NAT-ALP.....	39		
■ Repair clamps	40		
REPLINK inox.....	40		
REPLINK ALLINOX.....	42		
Ductile Iron REPLINK.....	42		

Flange adaptors

UltraQUICK

Very large tolerance, PFA 10-16 bar
DN 50-300 / DE 51-348

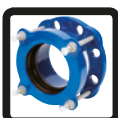

QUICK PVC simple

For PVC pipes, PFA 10-16 bar,
DN 40-200 / OD 40-225

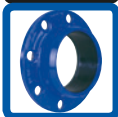

QUICK PVC anchored automatic

For PVC pipes, PFA 16 bar,
DN 40-200 / OD 40-225



QUICK GS anchored

For DI pipes, PFA 10-16 bar,
DN 60-200



QUICK GS simple

For PVC pipes, PFA 10-16 bar,
DN 60-300



QUICK GS simple, body in steel

Rilsan coating 250µm
PFA 10-16 bar OD 350-2000

(1) Epoxy coating: PFA 25 bar OD 1000-2000

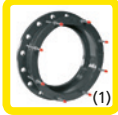

QUICK PE

anchored mechanical

PFA 10-16 bar, DE 63-400



DN	Materials				
	Ductile iron	Steel	PVC	Fiber-cement	PE
15					
40					
50					
60					
110					
150					
200					
300					
1000					
2000					



UltraQUICK - very large tolerance flange adaptor PFA 16 bar for pipes of ductile iron, steel, PVC and fiber-cement

- Ultra large tolerance (OD tolerance from 20 to 26 mm.)
- For pipes of grey iron, ductile iron, steel, PVC or fiber-cement
- Flanges drilling PN 10 and 16 for OD > 150.
- Outside diameter from 49 to 348 mm. Without any discontinuity
- Angular deflection: 6° max.

Type	DN flange	OD range		weight (kg)	reference PN 10 / 16
		mini (mm)	maxi (mm)		
A	50/60	49	71	3.3	MAA50HACHA
B	50/60/65/80	62	84	4.1	MAA50HACHB
C	65/80	80	102	4.3	MAA65HACHC
D	100	97	127	6.0	MAB10HACHD
E	125/150	123	153	7.9	MAB12HACHE
F	150	151	181	8.5	MAB15HACHF
FP	200	170	200	10.7	MAB20HACHP
G	200	196	226	10.7	MAB20HACHG
H	200	211	241	11.0	MAB20HACHH
I	250	235	265	15.2	MAB25HACHY
J	250	260	290	14.4	MAB25HACHJ
JR	300	285	315	20.2	MAB30HACHR
K	300	306	336	19.4	MAB30HACHK
L	300	318	348	18.9	MAB30HACHL

Centering tab gasket



Type	DN flange	weight (kg)	reference	
			ISO PN 10	ISO PN 16
A-B	50/60/65/80	0.02	MJA60UAXA	
C	65/80	0.03	MJA80UAXA	
D	100	0.04	MJB10UAXA	
E	125 and 150	0.06	MJB12UAXA	
F	150	0.09	MJB15UAXA	
FP-G-H	200	0.12	MJB20UAXA	
I-J	250	0.12	MJB25UAXA	162274
JR-K-L	300	0.09	MJB30UAXA	162275



simple version

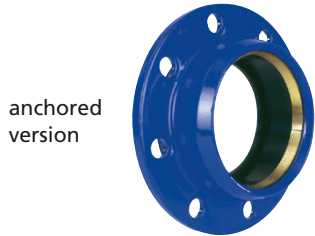

anchored version

QUICK PVC anchored automatic for PVC pipes - PFA 16 bar

OD	DN	simple version		anchored version	
		weight (kg)	reference	weight (kg)	reference
40	40	1.2	MAL40DACH	1.3	MAL40DBCH
50	40/50	1.5	MAL50DACH	1.6	MAL50DBCH
63	50	1.8	MAL60DACH	1.9	MAL60DBCH
63	60/65	2	MAL65DACH	2.1	MAL65DBCH
75	60/65	2.3	MAL75DACH	2.4	MAL75DBCH
90	80	2.6	MAL90DACH	2.8	MAL90DBCH
110	100	3.1	160754	3.4	MAM11DBCH
125	125	4.1	160755	4.3	MAM12DBCH
140	125	4.1	160756	4.3	MAM14DBCH
160	150	5.2	160757	5.7	MAM16DBCH
200	200*	7.5	160758	8.2	MAM20DBCH
225	200*	7.1	160759	7.7	MAM22DBCH

* Flange with combined drilling ISO PN 10 and ISO PN 16.
Packaging unitary.

QUICK PE anchored mechanic PFA 16 bar

OD	DN	weight (kg)	reference (PN 10/16)
63	50-60-65	3.30	MAL63UFCH
75	50-60-65	3.70	MAL75UFCH
90	80	4.78	MAL90UFCH
110	100	5.68	MAM11UFCH
125	100	7	MAM12UFCH
125	125	7	MAN12UFCH
140	125	7.50	MAM14UFCH
160	150	9	MAM16UFCH
180	150	10.10	MAM18UFCH
200	200	15.92	MAM20UFCH
225	200	17.50	MAM22UFCH
250	250	21.40	MAM25UFCH
280	250	21.70	MAM28UFCH
315	300	27.50	MAM31UFCH
400	400	67.50	MAM40UFCH



QUICK GS for ductile iron pipe PFA 16 bar

DN	simple version		anchored version	
	weight (kg)	reference	weight (kg)	reference
60-65	1.80	MAA60CACH	1.85	MAA60CBCH
80	2.25	MAA80CACH	2.30	MAA80CBCH
100	2.65	MAB10CACH	2.70	MAB10CBCH
125	3.65	MAB12CACH	3.70	MAB12CBCH
150	4.60	MAB15CACH	4.70	MAB15CBCH
200*	7.15	MAB20CACH	7.25	MAB20CBCH
250*	10.9	MAB25CACH		
300*	13.8	MAB30CACH		

* Flange with combined drilling ISO PN 10 and ISO PN 16.
Packaging unitary.



simple version



anchored version

QUICK GS simple for ductile iron pipes DN ≥ 350



Sealing Ring elastomer type EPDM.
Standard coating: black Rilsan 250 microns mini.

DN	DE (mm)	weight (kg)	PFA 10		PFA 16	
			reference	weight (kg)	reference	
350	378	24.2	MAB35WCBR	25.4	MAB35WCAR	
400	429	27.9	MAB40WCBR	29.5	MAB40WCAR	
450	480	35.7	MAB45WCBR	39.6	MAB45WCAR	
500	532	40.3	MAB50WCBR	48	MAB50WCAR	
600	635	49.2	MAB60WCBR	61.7	MAB60WCAR	
700	738	60.2	MAB70WCBR	62.6	MAB70WCAR	
800	842	73.1	MAB80WCBR	74.5	MAB80WCAR	
900	945	105	MAB90WCBR	107	MAB90WCAR	
1000	1048	121	MAC10WCBR	128	MAC10WCAR	

Packaging unitary.



Sealing Ring elastomer type EPDM. Standard version coating: epoxy mini 250 microns.
Flanges : dimensions in conformity with ISO 7005-2, ISO 2531, EN 1092-2.

DN	DE		PN 10		PN 16	
	DE nominal (mm)	tolerance (mm)	weight (kg)	reference	weight (kg)	reference
1000	1048	+2/7	236	160774	280	160775
1100	1151	+2/-7	274	163792	330	176401
1200	1255	+3/-7.5	345	163797	420	163798
1400	1462	+3/-7.5	440	171705	502	163809
1500	1565	+2.5/-8	484	163817	784	171708
1600	1668	+2.5/-8	572	163824	662	173405
1800	1875	+2/-8.5	750	160793	865	160794
2000	2082	+1/-9.5	1125	160796	1250	160797

Reinforced version: please, consult us.



QUICK GS PFA 25 bar for ductile iron pipes DN 50 up to 2000

Sealing Ring elastomer type EPDM. Standard version coating: epoxy mini 250 microns.
Flanges : dimensions in conformity with ISO 7005-2, ISO 2531, EN 1092-2.

DN	OD		weight (kg)	reference	
	OD nominal (mm)	tolerance (mm)		standard version	reinforced version
50	66	+1/-2	8	177016	please, consult us
65	77	+1/-2	11	177017	
80	98	+1/-2	13	177018	166664
100	118	+1/-2.5	16	176982	163866
125	144	+1/-2.5	20	177019	please, consult us
150	170	+1/-2.5	25	176983	163890
200	222	+1/-2.5	34	176984	163908
250	274	+2/-5	52	177020	163928
300	326	+2/-5	64	177031	163948
350	378	+2/-5	86	163975	163976
400	429	+2/-5	100	163993	163994
450	480	+2/-5	112	177456	please, consult us
500	532	+2/-5	132	164022	
600	635	+3/-6	181	164040	
700	738	+3/-6	220	164055	
800	842	+2/-7	276	164067	
900	945	+2/-7	330	164077	
1000	1048	+2/-7	400	163786	
1100	1151	+2/-7	595	160788	
1200	1255	+3/-7.5	698	177032	
1400	1462	+3/-7.5	937	160790	
1500	1565	+2.5/-8	1098	160791	
1600	1668	+2.5/-8	1173	160792	
1800	1875	+2/-8.5	1490	160795	
2000	2082	+1/-9.5	2166	160798	

Reinforced version: please, consult us.

Couplings

Ultra LINK

Very large tolerance,
PFA 10-16 bar
DN 50-300 OD 49-348



LINK GS

For DI pipes,
PFA 10-16 bar,
DN 40-600 OD 55-636



LINK GS steel body

For DI pipes,
PFA 10-16 bar,
DN 350-1000



LINK GS steel body blue epoxy

For DI pipes, PFA 25 bar,
DN 50-2000



FixLINK anchored

For DI pipes,
DN 60-300



FixLINK anchored

For PVC & PE pipes
PFA 16 bar,
DN 63-280



Link PE / PVC anchored mechanical

PFA 10-16 bar,
OD 63-315



NAT-ALP

for DI pipes
DN 80-400



- Ultra large tolerance (OD tolerance from 20 to 26 mm).
- For pipes of grey iron, ductile iron, steel, PVC or fiber-cement.
- Outside diameter from 49 to 348 mm. without any discontinuity.
- Angular deflection: 6° max.

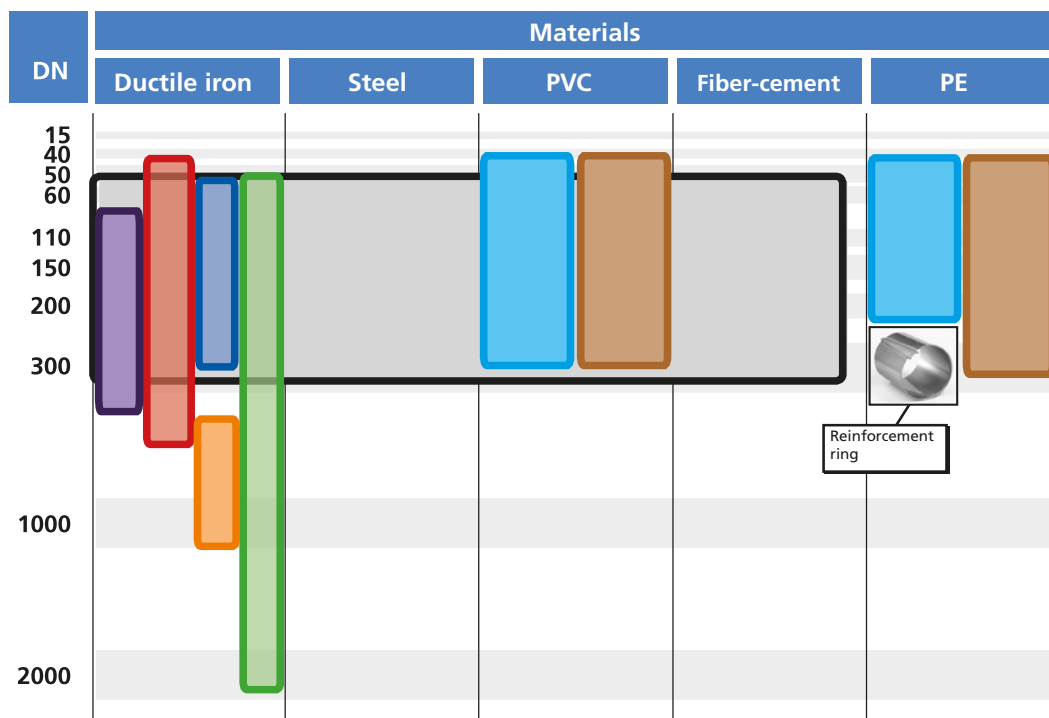

UltraLINK very wide tolerance coupling PFA 16 bar for pipes of ductile iron, steel, PVC and fiber-cement

Type	OD range		weight (kg)	reference
	mini mm	maxi mm		
A	49	71	3.6	MCX65RAAHA
B	62	84	4.1	MCX75RAAHB
C	80	102	4.9	MCX90RAAHC
D	97	127	7.7	MCY11RAAHD
E	123	153	8.9	MCY14RAAHE
F	151	181	10.4	MCY16RAAHF
FP	170	200	11.5	MCY19RAAHP
G	196	226	13.9	MCY21RAAHG
H	211	241	14.8	MCY22RAAHH
I	235	265	16.2	MCY25RAAHY
J	260	290	18.1	MCY27RAAHJ
JR	285	315	21.3	MCY30RAAHR
K	306	336	22.9	MCY32RAAHK
L	318	348	23.7	MCY33RAAHL

LINK GS dedicated coupling for ductile iron pipes

DN	OD range		PFA bar	weight (kg)	reference
	mini (mm)	maxi (mm)			
40	55	58	40	3.26	160280
60	76	79		4.0	MCA60KAEH
80	97	100		4.8	MCA80KAEH
100	117	120		6.18	MCB10KAEH
125	143	146	25	7.6	MCB12KADH
150	168	172		9.6	MCB15KADH
200	220	223		14	MCB20KADH
250	272	275		18.1	MCB25KADH
300	323	327	16	22.2	MCB30KADH
350	375	379		28.3	MCB35KAAH
400	426	430		33.4	MCB40KAAH
450	477	481		37.9	MCB45KAAH
500	529	533		45.6	MCB50KAAH
600	631	636		58.6	MCB60KAAH



LINK GS dedicated coupling for ductile iron pipes PFA16 DN 350 up to 1000

Sealing Ring elastomer type EPDM, steel body.
Coating: black Rilsan 250 microns mini.



DN	OD		weight (kg)	reference
	OD nominal (mm)	tolerance (mm)		
350	378	+2.5/-5.5	21.2	MCB35WAAR
400	429	+2.5/-5.5	23.7	MCB40WAAR
450	480	+2.9/-4	26.2	MCB45WAAR
500	532	+3.5/-4.5	29.2	MCB50WAAR
600	635	+3/-5	34.2	MCB60WAAR
700	738	+3.5/-4.5	39.6	MCB70WAAR
800	842	+1/-7	45	MCB80WAAR
900	945	+2/-6	88.3	MCB90WAAR
1000	1048	+1/-7	96.8	MCC10WAAR

LINK GS dedicated coupling for ductile iron pipes PFA25 DN 50 up to 2000

Sealing Ring elastomer type EPDM, steel body.



DN	OD		weight (kg)	reference	
	OD nominal (mm)	tolerance (mm)		standard version	reinforced version
50	66	+1/-2	4.5	177078	—
60	77	+1/-2	6	177077	—
80	98	+1/-2	8	177076	—
100	118	+1/-2.5	10	177075	199333
125	144	+1/-2.5	13	177074	—
150	170	+1/-2.5	15	177073	205105
200	222	+1/-2.5	21	177072	205106
250	274	+2/-5	25	177071	208372
300	326	+2/-5	34	177070	205108
350	378	+2/-5	42	163980	163981
400	429	+2/-5	50	164000	205109
450	480	+2/-5	55	177457	—
500	532	+2/-5	62	164027	164028
600	635	+3/-6	104	164044	164045
700	738	+3/-6	120	164058	164059
800	842	+2/-7	144	160781	164071
900	945	+2/-7	160	164079	205141
1000	1048	+2/-7	186	163790	—
1100	1151	+2/-7	200	please, consult us	—
1200	1255	+3/-7.5	332	163804	163805
1400	1462	+3/-7.5	390	163814	163815
1500	1565	+2.5/-8	440	163823	—
1600	1668	+2.5/-8	450	163828	—
1800	1875	+2/-8.5	665	177079	—
2000	2082	+1/-9.5	740	177080	223701

Unknowledge references reinforced version: please, consult us.

Anchored mecanic Link dedicated coupling for PE/PVC pipes - PFA 16 bar



OD	PFA	weight (kg)	reference (PN 10/16)
63	16	3.54	MCL63UBAH
75	16	4.64	MCL75UBAH
90	16	5.86	MCL90UBAH
110	16	6.70	MCM11UBAH
125	16	7.92	MCM12UBAH
140	16	8.88	MCM14UBAH
160	16	10.72	MCM16UBAH
180	16	12.70	MCM18UBAH
200	16	19.94	MCM20UBAH
250	16	25.54	MCM25UBAH
315	10	33.00	MCM28UBAH

FixLink GS anchored dedicated coupling for ductile iron pipes



DN	OD maxi	OD mini	PFA	weight (kg)	reference
60	76	78	16	0.95	MCA60NBAZ
80	95	100	16	1.15	MCA80NBAZ
100	115	120	16	1.25	MCB10NBAZ
125	141	146	16	1.89	MCB12NBAZ
150	167	171	16	2.14	MCB15NBAZ
200	219	224	16	7.1	MCB20NBAZ
250	270	276	16	8.74	MCB25NBAZ
300	322	329	10	9.9	MCB30NBAZ

Angular deflection : + or - 2%.
The setting torque is indicated on the product label.

FixLink anchored dedicated coupling for PVC/PE pipes PFA 16



OD	OD maxi	OD mini	weight (kg)	reference
63	62	64	0.9	MCL63PBAZ
75	74	75	1.4	MCL75PBAZ
90	89	91	1.6	MCL90PBAZ
110	108	111	1.7	MCM11PBAZ
125	123	126	2.5	MCM12PBAZ
140	139	142	2.7	MCM14PBAZ
160	158	162	2.9	MCM16PBAZ
180	178	182	7.8	MCM18PBAZ
200	198	203	8.2	MCM20PBAZ
225	222	227	8.6	MCM22PBAZ
250	247	253	9.4	MCM25PBAZ
280	277	283	11.5	MCM28PBAZ

Angular deflection : + or - 2%.
The setting torque is indicated on the product label.

Reinforcement ring for PE pipes

Insert a reinforcement ring at each end of the PE.
Material: type Z6CND 17-12 stainless steel.



OD tube PE	weight (kg)	PE 80 PN 10 SDR 13.6	PE 100 PN 10 SDR 17	PE 100 PN 16 SDR 11
40	0.1	MBL40QEBZ	MBL40QGBZ	MBL40QHAZ
50	0.1	MBL50QEBZ	MBL50QGBZ	MBL50QHAZ
63	0.2	MBL63QEBZ	MBL63QGBZ	MBL63QHAZ
75	0.2	MBL75QEBZ	MBL75QGBZ	MBL75QHAZ
90	0.2	MBL90QEBZ	MBL90QGBZ	MBL90QHAZ
110	0.3	MBM11QEBZ	MBM11QGBZ	MBM11QHAZ
125	0.3	MBM12QEBZ	MBM12QGBZ	MBM12QHAZ
140	0.4	MBM14QEBZ	MBM14QGBZ	MBM14QHAZ
160	0.4	MBM16QEBZ	MBM16QGBZ	MBM16QHAZ
180	0.6	MBM18QEBZ	MBM18QGBZ	MBM18QHAZ
200	0.7	MBM20QEBZ	MBM20QGBZ	MBM20QHAZ
225	0.8	MBM22QEBZ	MBM22QGBZ	MBM22QHAZ
250	1.8	MBM25QEBZ	MBM25QGBZ	MBM25QHAZ
280	2.03	MBM28QEBZ	MBM28QGBZ	MBM28QHAZ

NAT-ALP repair coupling for DI Pipes



OD range	weight (kg)	reference
80	34.76	ANA80MNOK
100	50.52	ANB10MNOK
125	62.93	ANB12MNOK
150	91.22	ANB15MNOK
200	169.71	ANB20MN
250	182.0	ANB25MNOK
300	205.91	ANB30MNOK
350	345.28	ANB35MNOK
400	439.26	ANB40MNOK

REPLINK Inox Repair collar for pipes of ductile iron, steel, PVC



Single clamp - length: 80 mm

OD range	PFA	weight (kg)	reference
21-25	35	0.30	MRX21AAXHM
26-30	35	0.30	MRX26AAXHM
29-33	35	0.30	MRX29AAXHM
33_37	30	0.30	MRX33AAXHM
38-42	30	0.30	MRX38AAXHM
42-45	25	0.35	MRX42AAXHM
44-48	25	0.26	MRM44AAXXMN
48-51	25	0.35	MRX48AAXHM
50-54	22	0.28	MRM50AAXXMN
55-60	22	0.28	MRM55AAXXMN
60-64	20	0.35	MRX60AAXHM
65-69	20	0.45	MRM65AAXXMN
69-73	20	0.46	MRM69AAXXMN
71-76	18	0.50	MRX71AAXHM
76-82	18	0.48	MRM76AAXXMN
82-87	15	0.50	MRM82AAXXMN
87-93	15	0.55	MRX87AAXHM
94-100	15	0.53	MRM94AAXXMN
99-104	15	0.53	MRM99AAXXMN
105-111	13	0.54	MRN05AAXXMN
112-118	13	0.60	MRY11AAXHM
120-126	13	0.64	MRN20AAXXMN
126-131	10	0.66	MRN26AAXXMN
131-136	10	0.68	MRN31AAXXMN
139-145	10	0.70	MRN39AAXXMN
156-162	8	0.72	MRN56AAXXMN
167-173	8	0.74	MRN67AAXXMN
173-179	8	0.76	MRN73AAXXMN
217-223	8	0.84	MRP17AAXXMN
223-229	6	0.90	MRP23AAXXMN

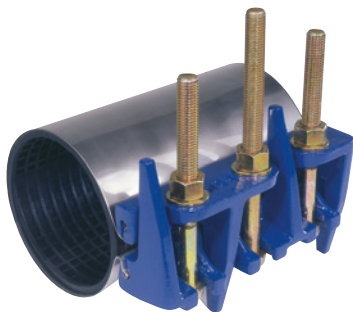

Single clamp - lengths: 200 mm and 300 mm

OD range	PFA	length = 200 mm - 3 bolts		length = 300 mm - 4 bolts	
		weight (kg)	reference	weight (kg)	reference
48-56	32	3.6	MRX50AAXHEN	-	-
56-64	31	3.7	MRX60AAXHEN	-	-
60-68	30	3.8	MRX65AAXHEN	-	-
68-78	29	3.8	MRX70AAXHEN	-	-
78-88	28	3.9	MRX80AAXHEN	5.9	MRX80AAXHGN
88-98	26	4	MRX90AAXHEN	6.1	MRX90AAXHGN
98-108	25	4.1	MRY10AAXHEN	6.2	MRY10AAXHGN
108-118	23	4.1	MRY11AAXHEN	6.3	MRY11AAXHGN
114-126	22,5	4.2	MRY12AAXHEN	6.4	MRY12AAXHGN
126-138	21,5	4.3	MRY13AAXHEN	6.5	MRY13AAXHGN
138-150	20	4.4	MRY14AAXHEN	6.7	MRY14AAXHGN
140-153	20	4.4	MRY15AAXHEN	6.7	MRY15AAXHGN
150-162	19	4.4	MRY16AAXHEN	6.8	MRY16AAXHGN
162-174	17	4.5	MRY17AAXHEN	6.9	MRY17AAXHGN
168-182	16,5	4.6	MRYA7AAXHEN	7	MRYA7AAXHGN
174-186	16	4.7	MRY18AAXHEN	7	MRY18AAXHGN
186-198	15	4.8	MRY19AAXHEN	7.3	MRY19AAXHGN
198-210	13,5	4.9	MRY20AAXHEN	7.4	MRY20AAXHGN
210-223	13	5	MRY22AAXHEN	7.5	MRY22AAXHGN
222-234	12	5	MRY23AAXHEN	7.7	MRY23AAXHGN
234-246	11	5.1	MRY24AAXHEN	7.8	MRY24AAXHGN
243-255	10,5	5.2	MRY25AAXHEN	7.9	MRY25AAXHGN
260-272	9,5	5.3	MRY27AAXHEN	8	MRY27AAXHGN
273-285	9	5.4	MRY28AAXHEN	8.3	MRY28AAXHGN
285-297	8,5	5.5	MRY29AAXHEN	8.4	MRY29AAXHGN
298-310	8	5.6	MRY30AAXHEN	-	-



REPLINK Inox Repair collar for pipes of ductile iron, steel, PVC

Double clamp

OD range	PFA	length = 200 mm - 3 bolts		length = 300 mm - 4 bolts		length = 500 mm - 7 bolts	
		weight (kg)	reference	weight (kg)	reference	weight (kg)	reference
88-110	26	7.2	MRY10BAXHEN	—	—	—	—
114-137	22.5	7.4	MRY12BAXHEN	11.5	MRY12BAXHGN	—	—
138-160	20	7.6	MRY15BAXHEN	11.7	MRY15BAXHGN	—	—
160-182	17	7.7	MRY17BAXHEN	11.8	MRY17BAXHGN	—	—
182-202	15.5	8.0	MRY20BAXHEN	12.2	MRY20BAXHGN	20.8	MRY20BAXHHN
202-224	13.5	8.1	MRY22BAXHEN	12.3	MRY22BAXHGN	21.0	MRY22BAXHHN
217-240	12.5	8.2	MRY24BAXHEN	12.4	MRY24BAXHGN	21.2	MRY24BAXHHN
240-262	10.5	—	—	12.8	MRY25BAXHGN	21.7	MRY25BAXHHN
262-284	9.5	—	—	12.9	MRY28BAXHGN	22.3	MRY28BAXHHN
273-296	9	—	—	13.4	MRY29BAXHGN	22.6	MRY29BAXHHN
296-319	8	—	—	13.3	MRY30BAXHGN	23.0	MRY30BAXHHN
324-346	6.5	—	—	13.6	MRY33BAXHGN	23.8	MRY33BAXHHN
346-368	6	—	—	13.8	MRY35BAXHGN	23.8	MRY35BAXHHN
365-387	5.5	—	—	14.0	MRY37BAXHGN	24.3	MRY37BAXHHN
387-410	4.5	—	—	14.3	MRY40BAXHGN	25.6	MRY40BAXHHN
410-432	4	—	—	14.6	MRY42BAXHGN	26.1	MRY42BAXHHN
428-450	3.5	—	—	14.8	MRY44BAXHGN	25.8	MRY44BAXHHN
450-474	3	—	—	15.6	MRY46BAXHGN	27.0	MRY46BAXHHN
470-492	2.5	—	—	15.7	MRY48BAXHGN	27.3	MRY48BAXHHN
492-516	2.5	—	—	15.8	MRY50BAXHGN	27.8	MRY50BAXHHN

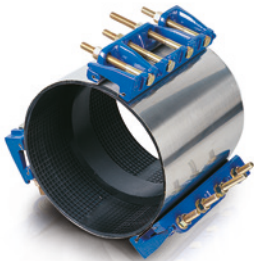

Triple clamp

OD range	PFA	length = 200 mm - 3 bolts		length = 300 mm - 4 bolts		length = 500 mm - 7 bolts	
		weight (kg)	reference	weight (kg)	reference	weight (kg)	reference
300-330	7	12.2	MRY30CAXHEN	18.2	MRY30CAXHGN	31.3	MRY30CAXHHN
330-360	6	12.2	MRY33CAXHEN	18.4	MRY33CAXHGN	31.8	MRY33CAXHHN
360-390	5.5	12.8	MRY36CAXHEN	18.7	MRY36CAXHGN	32.2	MRY36CAXHHN
390-420	4	12.8	MRY39CAXHEN	19.2	MRY39CAXHGN	33	MRY39CAXHHN
420-450	3.5	13.6	MRY42CAXHEN	19.5	MRY42CAXHGN	34.1	MRY42CAXHHN
450-480	3	13.7	MRY45CAXHEN	19.7	MRY45CAXHGN	34.2	MRY45CAXHHN
480-510	2.5	13.8	MRY48CAXHEN	19.9	MRY48CAXHGN	34.3	MRY48CAXHHN
510-540	2	13.8	MRY51CAXHEN	20	MRY51CAXHGN	35.8	MRY51CAXHHN
540-570	2	13.9	MRY54CAXHEN	20.8	MRY54CAXHGN	36.7	MRY54CAXHHN
570-600	2	14.3	MRY57CAXHEN	21.4	MRY57CAXHGN	36.9	MRY57CAXHHN
600-630	2	14.4	MRY60CAXHEN	21.6	MRY60CAXHGN	38.2	MRY60CAXHHN
630-660	2	14.4	MRY63CAXHEN	21.7	MRY63CAXHGN	38.4	MRY63CAXHHN
660-690	2	14.7	MRY66CAXHEN	22.4	MRY66CAXHGN	40.3	MRY66CAXHHN
690-720	2	15.4	MRY69CAXHEN	22.6	MRY69CAXHGN	40.5	MRY69CAXHHN
720-750	1	15.5	MRY72CAXHEN	23.2	MRY72CAXHGN	—	—

Repair clamps stainless steel "ALLINOX®" for ductile iron pipes, Steel and PVC tubes



Single clamp - length: 200 mm, 3 bolts.

OD range	PFA	weight (kg)	reference
60-68	30	2.8	MRX65ABXXE
68-78	29	2.8	MRX70ABXXE
78-88	28	2.9	MRX80ABXXE
88-98	26	3.0	MRX90ABXXE
98-108	25	3.0	MRY10ABXXE
108-118	23	3.1	MRY11ABXXE
114-126	22.5	3.1	MRY12ABXXE
126-138	21.5	3.2	MRY13ABXXE

RepLink in ductile iron - 2 clamps PFA 16 bar for ductile iron, steel and PVC pipes



Type	DN	OD		weight (kg)	reference
		mini	maxi		
W2-A	40	54	61	5.6	MRA40SACA
W2-B	50	60	68	5.9	MRA50SACB
W2-C	60	76	87	8.3	MRA60SACC
W2-D	80	89	98	8.6	MRA80SACD
W2-F	80	95	108	8.4	MRA80SACF
W2-G	100	108	118	11.6	MRB10SACG
W2-I	100	116	128	11.2	MRB10SACY
W2-J	125	133	144	13.8	MRB12SACJ
W2-L	125	142	153	13.7	MRB12SACL
W2-M	150	159	172	21.3	MRB15SACM
W2-P	150	168	184	22.3	MRB15SACP
W2-Q	175	193	203	39.9	MRB17SACQ
W2-R	200	214	225	37.5	MRB20SACR
W2-S	250	267	274	42.5	MRB25SACS
W2-T	275	290	303	54.5	MRB27SACT
W2-U	300	315	326	73.0	MRB30SACU

RepLink in ductile iron - 3 clamps PFA 10 bar for ductile iron, steel and PVC pipes



Type	DN	OD		weight (kg)	reference
		mini	maxi		
W3-H	200	218	250	25.5	MRB20SACH
W3-I	250	267	298	46.0	MRB25SACY
W3-J	300	315	358	59.6	MRB30SACJ
W3-K	350	400	505	85.0	MRB35SACK
W3-N	400	429	505	89.0	MRB40SACN

Self-anchored dismantling joint large stroke for flanged valves

These equipments comply with the standard NFE 29220, specially concerning the flanges dimensions according to NFE 29203 and 29209.

The full-flange sliding body: the flange is according to ISO 7005 standard.

The stroke range is higher than those demanded in the NFE 29220.

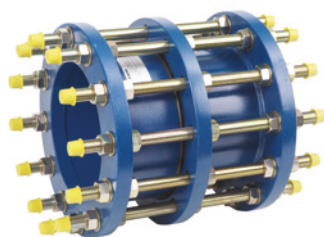

DN	standard version						reinforced version		
	PFA 10		PFA 16		PFA 25		PFA 10	PFA 16	PFA 25
	weight (kg)	reference	weight (kg)	reference	weight (kg)	reference	reference	reference	reference
40	11	206620	11	206620	13	206348	—	—	163515
50	13	206633	13	206633	17	206349	160944	160944	163524
65	15	184034	15	184034	19	206446	160946	160946	—
80	21	183212	21	183212	26	204089	160949	160949	163548
100	22	183213	22	183213	31	206513	163561	163561	163562
125	28	184481	28	184481	36	206514	—	—	163589
150	37	183214	37	183214	48	206516	163607	163607	163608
200	53	183783	60	183627	73	184600	—	MDB20DAAP	163637
250	72	206550	84	183628	102	205292	—	MDB25DAAP	163662
300	81	184220	99	183640	142	184611	MDB30DABP	MDB30DAAP	163681
350	109	206677	143	183682	191	185346	160957	—	163697
400	150	206678	170	183634	245	206517	160958	MDB40DAAP	163713
450	180	206679	187	206546	272	206518	160959	—	163720
500	206	206680	279	183702	347	198572	160960	MDB50DAAP	163734
600	264	184918	395	183626	476	183856	160961	160962	163743
700	256	210092	366	198954	571	MDB70DADH	160963	—	163753
800	352	210082	482	184075	800	MDB80DADH	160964	MDB80DAAP	163764
900	405	236294	546	219967	920	MDB90DADH	160965	MDB90DAAP	163773
1000	484	236295	715	236296	1280	MDC10DADH	160952	MDC10DAAP	163564
1100	585	236297	810	236298	1600	MDC11DADH	—	—	—
1200	744	236301	1112	184329	1871	MDC12DADH	—	MDC12DAAP	163591
1400	1036	MDC14DABH	1352	MDC14DAAH	2393	163600	—	MDC14DAAP	163599
1500	1165	MDC15DABH	1580	MDC15DAAH	2805	MDC15DADH	—	—	—
1600	1524	MDC16DABH	1400	MDC16DAAH	3132	MDC16DADH	—	MDC16DAAP	—
1800	1994	MDC18DABH	2400	MDC18DAAH	3850	MDC18DADH	—	MDC18DAAP	—
2000	2400	MDC20DABH	2800	MDC20DAAH	4560	MDC20DADH	—	—	—

Designation	Material	
	Standard version	Reinforced version
Fixed body	Epoxy Powder 250µ mini	Epoxy coating 300µ mini
Gland		
Sliding body	Zinc plating 12µ	Hot dipped galvanized 40µ
Tie bars		

Dismantling joint type PF for valves without flanges



DN	PFA 10 bar		PFA 16 bar	
	weight (kg)	reference	weight (kg)	reference
50	10	160943	10	160943
65	16	163543	16	163543
80	21	160947	21	160947
100	20	163559	20	163559
125	34	166645	34	166645
150	34	163605	34	163605
200	48	163634	64	160966
250	74	163658	102	163659
300	100	173460	116	160969
350	124	166654	162	173472
400	160	163707	204	171567
500	202	160970	312	163731
600	268	160971	416	163742
700	330	163750	444	173475
800	454	163762	610	160942
900	522	163770	692	173476
1000	632	160950	890	160951
1200	1200	163586	1392	173477

Please consult us for DN 450.

Tapping collar MGD for steel / iron / asbestos cement pipes



- Spheroidal cast iron saddle and threaded nozzle
- EPDM gasket suitable for use on drinking water service pipes.
- PFA 16 bar.
- Epoxy paint, 250 micron thickness.
- Stainless steel bracket.
- Gas female thread ISO228/1 Complies

DN mm	RANGE OF mm	N° Bracke TS	DN DERIVATION				
			3/4"	1"	1" 1/4	1" 1/2	2"
30*	40 - 50	1	RSL30PCAC	RSL40PDAC			
40	48 - 55	1	RSL40PCAC	RSA50PDAC			
50	60 - 68	1	RSA50PCAC	RSA60PDAC	RSA50PEAC	RSA50PFAC	
60	72 - 80	1	RSA60PCAC	RSL70PDAC	RSA60PEAC	RSA60PFAC	
70	76 - 84	1	RSL70PCAC	182206	RSL70PEAC	RSL70PFAC	
80	88 - 104	1	182205	RSL90PDAC	RSA80PEAC	RSA80PFAC	163497
90	102 - 112	1	RSL90PCAC	163476	RSL90PEAC	RSL90PFAC	208967
100	112 - 126	1	182207	RSB12PDAC	163481	RSB10PFAC	163498
125	140 - 154	1	RSB12PCAC	163478	RSB12PEAC	RSB12PFAC	RSB12PGAC
150	168 - 184	1	163475		163483	RSB15PFAC	163500
		2			RSB15PEAE	RSB15PFAE	RSB15PGAE
175	190 - 205	1	RSM17PCAC	RSM17PDAC	RSM17PEAC	RSM17PFAC	RSM17PGAC
		2			RSM17PEAE	RSM17PFAE	RSM17PGAE
200	218 - 234	1	RSB20PCAC	RSB20PDAC	163485	RSB20PFAC	163502
		2			RSB20PEAE	RSB20PFAE	RSB20PGAE
225	245 - 260	1	RSM22PCAC	RSM22PDAC	RSM22PEAC	RSM22PFAC	RSM22PGAC
		2			RSM22PEAE	RSM22PFAE	RSM22PGAE
250	272 - 286	1	RSB25PCAC	RSB25PDAC	RSB25PEAC	RSB25PFAC	163503
		2			RSB25PEAE	RSB25PFAE	RSB25PGAE
300	322 - 344	1			RSB30PEAC	RSB30PFAC	163504
		2			RSB30PEAE	RSB30PFAE	RSB30PGAE
350	356 - 384	2			RSB35PEAE	RSB35PFAE	163505
400	425 - 458	2			166639	RSB40PFAE	163506
450	475 - 516	2				RSB45PFAE	RSB45PGAE
500	530 - 570	1				RSB50PFAE	RSB50PGAE
600	620 - 645	2				RSB60PFAE	RSB60PGAE

DN mm	RANGE OF mm	N° Bracke TS	DN DERIVATION			
			2" 1/2	3"	4"	5"
30*	40 - 50	1				
40	48 - 55	1				
50	60 - 68	1				
60	72 - 80	1				
70	76 - 84	1				
80	88 - 104	1				
90	102 - 112	1				
100	112 - 126	1				
125	140 - 154	1	RSB12PHAC	RSB12PJAC		
150	168 - 184	1	RSB15PHAC	RSB15PJAC		
		2	RSB15PHAE	RSB15PJAE		
175	190 - 205	1	RSM17PHAC	RSM17PJAC		
		2	RSM17PHAE	RSM17PJAE		
200	218 - 234	1				
		2	RSB20PHAE	RSB20PJAE	RSB20PKAE	
225	245 - 260	1				
		2	RSM22PHAE	RSM22PJAE	RSM22PKAE	
250	272 - 286	1				
		2	RSB25PHAE	RSB25PJAE	RSB25PKAE	
300	322 - 344	1				RSB30PLAE
		2	RSB30PHAE	RSB30PJAE	RSB30PKAE	RSB30PLAE
350	356 - 384	2	RSB35PHAE	RSB35PJAE	RSB35PKAE	RSB35PLAE
400	425 - 458	2	RSB40PHAE	RSB40PJAE	RSB40PKAE	
450	475 - 516	2	RSB45PHAE	RSB45PJAE	RSB45PKAE	RSB45PLAE
500	530 - 570	1	RSB50PHAE	RSB50PJAE	RSB50PKAE	RSB50PLAE
600	620 - 645	2	RSB60PHAE	RSB60PJAE	RSB60PKAE	RSB60PLAE

For other sizes (up to dn 700) and tolerances: consult us
 For 2-brack collars sizes dn 150 to dn 300: consult us
 Version with nbr gasket available on request

Tapping collar MGD pc for steel / cast iron and asbestos cement for under pressure installation



- Spheroidal cast iron saddle and threaded nozzle
- EPDM gasket suitable for use on drinking water service pipes.
 - PFA 16 bar.
 - Epoxy paint, 250 micron thickness.
 - Stainless steel bracket.
 - Gas female thread ISO228/1 Complies with EN 545-7.4



DN mm	RANGE OF mm	N° Brackets	DN DERIVATION			
			3/4"	1"	1" 1/4	1" 1/2
50	60 - 68	1	RSA50QCAC	RSA50QDAC	RSA50QEAC	
60	72 - 80	1	RSA60QCAC	RSA60QDAC	RSA60QEAC	
70	76 - 84	1	RSL70QCAC	RSL70QDAC	RSL70QEAC	
80	88 - 104	1	RSA80QCAC	RSA80QDAC	RSA80QEAC	RSA80QFAC
90	102 - 112	1	RSL90QCAC	RSL90QDAC	RSL90QEAC	RSL90QFAC
100	112 - 126	1	RSB10QCAC	RSB10QDAC	RSB10QEAC	RSB10QFAC
125	140 - 154	1	RSB12QCAC	RSB12QDAC	RSB12QEAC	RSB12QFAC
150	168 - 184	1	RSB15QCAC	RSB15QDAC	RSB15QEAC	RSB15QFAC
175	190 - 205	1	RSM17QCAC	RSM17QDAC	RSM17QEAC	RSM17QFAC
200	218 - 234	1		RSB20QDAC	RSB20QEAC	RSB20QFAC
		2			RSB20QEAE	RSB20QFAE
225	245 - 260	1		RSM22QDAC	RSM22QEAC	RSM22QFAC
		2				RSM22QFAE
250	272 - 286	1		RSB25QDAC	RSB25QEAC	RSB25QFAC
		2				RSB25QFAE
300	322 - 344	1		RSB30QDAC	RSB30QEAC	RSB30QFAC
		2				RSB30QFAE
350	356 - 384	2				RSB35QFAC
						RSB35QFAE
400	425 - 458	2				RSB40QFAC
						RSB40QFAE
450	475 - 516	2				RSB45QFAE
500	530 - 570	1				RSB50QFAE
600	620 - 645	2				RSB60QFAE

DN mm	RANGE OF mm	N° Brackets	DN DERIVATION		
			2"	2" 1/2	3"
50	60 - 68	1			
60	72 - 80	1			
70	76 - 84	1			
80	88 - 104	1	RSA80QGAC		
90	102 - 112	1			
100	112 - 126	1	RSB10QGAC		
125	140 - 154	1	RSB12QGAC		
150	168 - 184	1	RSB15QGAC		
175	190 - 205	1		RSB15QHAE	RSB15QJAE
200	218 - 234	1	RSM17QGAC		
		2	RSB20QGAC		
225	245 - 260	1	RSB20QGAE	RSB20QHAE	RSB20QJAE
		2	RSM22QGAC		
250	272 - 286	1	RSM22QGAE	RSM22QHAE	RSM22QJAE
		2	RSB25QGAC		
300	322 - 344	1	RSB25QGAE	RSB25QHAE	RSB25QJAE
		2	RSB30QGAC		
350	356 - 384	2	RSB30QGAE	RSB30QHAE	RSB30QJAE
			RSB35QGAC		
400	425 - 458	2	RSB35QGAE	RSB35QHAE	RSB35QJAE
			RSB40QGAC		
450	475 - 516	2	RSB40QGAE	RSB40QHAE	RSB40QJAE
500	530 - 570	1	RSB45QGAE		
600	620 - 645	2	RSB50QGAE		

For other sizes (up to dn 700) and tolerances: consult us
 For 2-brack collars sizes dn 150 to dn 300: consult us
 Version with nbr gasket available on request



Tapping collars of derivation flanges claw for pipe collars in steel / cast iron and asbestos cement

- Grey cast iron saddle and flange.
- EPDM gasket suitable for use on drinking water service pipes.
- Epoxy paint, 250 micron thickness.
- Double stainless steel bracket
- Flange drilling PN 10/16

MAIN DN mm	DE MIN mm	DE MAX mm	DN DERIVATION	
			80	100
150	168	184	RSB15ESAB	RSB15ETAB
200	218	246	RSB20ESAB	RSB20ETAB
250	272	298	RSB25ESAB	RSB25ETAB
300	322	355	RSB30ESAB	RSB30ETAB
350	356	414	RSB35ESAB	RSB35ETAB
400	406	460	RSB40ESAB	RSB40ETAB

Rubber bracket option
Version with nbr gasket available on request
Complies with standard en 545 paragraph 7.4



Tapping collar MANICOTTO for pvc / pe pipe

- Nodular cast iron half-bodies and threaded mouthpiece
- EPDM gasket suitable for use on drinking water service pipes.
- PFA 16 bar.
- Epoxy coating, 250 micron thickness
- Galvanised or stainless steel bolts available on request.
- Gas female thread ISO 228/1 (metric on request)

DN mm	SCREWS	DN DERIVATION				
		3/4"	1"	1" 1/4	1" 1/2	2"
50	zinc	RSL50MCAE	RSL50MDAE	RSL50MEAE		
	inox	RSL50MCAC	RSL50MDAC	RSL50MEAC		
63	zinc	RSL63MCAE	RSL63MDAE	RSL63MEAE	RSL63MFAE	RSL63MGAE
	inox	RSL63MCAC	RSL63MDAC	RSL63MEAC	RSL63MFAC	RSL63MGAC
75	zinc	RSL75MCAE	RSL75MDAE	RSL75MEAE	RSL75MFAE	RSL75MGAE
	inox	RSL75MCAC	RSL75MDAC	RSL75MEAC	RSL75MFAC	RSL75MGAC
90	zinc	RSL90MCAE	RSL90MDAE	RSL90MEAE	RSL90MFAE	RSL90MGAE
	inox	RSL90MCAC	RSL90MDAC	RSL90MEAC	RSL90MFAC	RSL90MGAC
110	zinc	RSM11MCAE	RSM11MDAE	RSM11MEAE	RSM11MFAE	RSM11MGAE
	inox	RSM11MCAC	RSM11MDAC	RSM11MEAC	RSM11MFAC	RSM11MGAC
125	zinc		RSM12MDAE	RSM12MEAE	RSM12MFAE	RSM12MGAE
	inox		RSM12MDAC	RSM12MEAC	RSM12MFAC	RSM12MGAC
140	zinc		RSM14MDAE	RSM14MEAE	RSM14MFAE	RSM14MGAE
	inox		RSM14MDAC	RSM14MEAC	RSM14MFAC	RSM14MGAC
160	zinc		RSM16MDAE	RSM16MEAE	RSM16MFAE	RSM16MGAE
	inox		RSM16MDAC	RSM16MEAC	RSM16MFAC	RSM16MGAC
180	zinc		RSM18MDAE	RSM18MEAE	RSM18MFAE	RSM18MGAE
	inox		RSM18MDAC	RSM18MEAC	RSM18MFAC	RSM18MGAC
200	zinc		RSM20MDAE	RSM20MEAE	RSM20MFAE	RSM20MGAE
	inox		RSM20MDAC	RSM20MEAC	RSM20MFAC	RSM20MGAC
225	zinc		RSM22MDAE	RSM22MEAE	RSM22MFAE	RSM22MGAE
	inox		RSM22MDAC	RSM22MEAC	RSM22MFAC	RSM22MGAC
250	zinc		211195	211225	211197	211226
	inox		225803		225802	211518
280	zinc				211228	211199
	inox					216873
315	zinc				211229	211200
	inox					237739



Tapping collar sleeve MANICOTTO PC for pvc / pe pipe

- Nodular cast iron half-bodies and threaded mouthpiece
- EPDM gasket suitable for use on potable water service pipes
- PFA 16 bar.
- Epoxy coating, 250 microns thickness.
- Galvanised steel connecting screws (stainless steel on request).
- Gas female thread ISO 228/1.
- Note: Different sizes, self-locking nuts and sleeve with clamping screw on threaded bracket without nut are available on request.

DN mm	SCREWS	DN DERIVATION				
		3/4"	1"	1" 1/4	1" 1/2	2"
50	zinc	RSL50NCAE	RSL50NDAE	RSL50NEAE		
	inox	RSL50NCAC	RSL50NDAC	RSL50NEAC		
63	zinc	RSL63NCAE	RSL63NDAE	RSL63NEAE		
	inox	RSL63NCAC	RSL63NDAC	RSL63NEAC		
75	zinc	RSL75NCAE	RSL75NDAE	RSL75NEAE		
	inox	RSL75NCAC	RSL75NDAC	RSL75NEAC		
90	zinc	RSL90NCAE	RSL90NDAE	RSL90NEAE	RSL90NFAE	RSL90NGAE
	inox	RSL90NCAC	RSL90NDAC	RSL90NEAC	RSL90NFAC	RSL90NGAC
110	zinc	RSM11NCAE	RSM11NDAE	RSM11NEAE	RSM11NFAE	RSM11NGAE
	inox	RSM11NCAC	RSM11NDAC	RSM11NEAC	RSM11NFAC	RSM11NGAC
125	zinc	RSM12NCAE	RSM12NDAE	RSM12NEAE	RSM12NFAE	RSM12NGAE
	inox	RSM12NCAC	RSM12NDAC	RSM12NEAC	RSM12NFAC	RSM12NGAC
160	zinc	RSM16NCAE	RSM16NDAE	RSM16NEAE	RSM16NFAE	RSM16NGAE
	inox	RSM16NCAC	RSM16NDAC	RSM16NEAC	RSM16NFAC	RSM16NGAC
200	zinc		RSM20NDAE	RSM20NEAE	RSM20NFAE	RSM20NGAE
	inox		RSM20NDAC	RSM20NEAC	RSM20NFAC	RSM20NGAC
225	zinc				RSM22NFAE	RSM22NGAE
	inox				RSM22NFAC	RSM22NGAC



MPE multi-material tapping collar for pvc, pe, steel, cast iron and asbestos cement pipes

- Ductile cast iron saddle and threaded nozzle.
- EPDM gasket suitable for use on drinking water service pipes.
- PFA 16 bar.
- Epoxy coating, 250 micron thickness.
- Elastomer+ stainless steel bracket.
- Gas female thread ISO 228/1 (metric on request).
- Complies with EN 545-7.4

DN mm	RANGE OF mm	N° Brackets	DN DERIVATION				
			3/4"	1"	1" 1/4	1" 1/2	2"
63	60 - 67	1	182834	175715	182836	175756	
75	75 - 83	1	RSL75CCAC	182837	182839	RSL75CFAC	
90	88 - 100	1	182842	182843	182844	182845	182846
110	110 - 122	1	182849	182848	182850	182851	182852
125	125 - 137	1	175757	175716	182861	175755	182853
140	139 - 150	1	182874	RSM14CDAC	RSM14CEAC	182875	183313
160	160 - 172	1	RSM16CCAC	182877	182880	182882	182873
180	180 - 192	1	175758	175717	RSM16CEAC	175752	182885
200	200 - 220	1	RSM20CCAC	RSM20CDAC	182905	182906	182904
		2			RSM20CEAE	RSM20CFAE	RSM20CGAE
225	222 - 234	1	RSM22CCAC	175718	182908	175751	182907
		2			RSM22CEAE	RSM22CFAE	RSM22CGAE
250	250 - 275	1		RSM25CDAC		182993	182994
		2		RSM25CDAE		RSM25CFAE	RSM25CGAE
315	315 - 336	1		175719		175740	RSM31CGAC
		2		RSM31CDAE		RSM31CFAE	RSM31CGAE

For different sizes and tolerances: consult us.
 DE 250 and 315 2 1/2" on request
 for 2-bracket collars: consult us
 version with nbr gasket available on request



Tapping collar MPE pc multimaterial

- Ductile cast iron saddle and threaded nozzle.
- EPDM gasket suitable for use on drinking water service pipes.
- PFA 16 bar.
- Epoxy coating, 250 micron thickness
- Elastomer+ stainless steel bracket.
- Gas female thread ISO 228/1 (metric on request). Complies with EN 545-7.4

DN mm	RANGE OF mm	N° Brackets	DN DERIVATION				
			3/4"	1"	1" 1/4	1" 1/2	2"
70	75 - 83	1	RSL75DCAC	RSL75DDAC	RSL75DEAC		
90	88 - 100	1	RSL90DCAC	RSL90DDAC	RSL90DEAC	RSL90DFAC	RSL90DGAC
110	110 - 122	1	RSM11DCAC	RSM11DDAC	RSM11DEAC	RSM11DFAC	RSM11DGAC
125	125 - 137	1	RSM12DCAC	175720	RSM12DEAC	RSM12DFAC	RSM12DGAC
140	139 - 150	1	RSM14DCAC	RSM14DDAC	RSM14DEAC	RSM14DFAC	RSM14DGAC
160	160 - 172	1	RSM16DCAC	RSM16DDAC	RSM14DEAC	RSM16DFAC	RSM16DGAC
180	180 - 192	1	RSM18DCAC	175731	RSM18DEAC	RSM18DFAC	RSM18DGAC
200	200 - 220	1		RSM20DDAC	RSM20DEAC	RSM20DFAC	RSM20DGAC
		2		RSM20DDAE	RSM22DEAC	RSM20DFAE	RSM20DGAE
225	222 - 234	1		175732	RSM22DEAE	RSM22DFAC	RSM22DGAC
		2		RSM22DDAE		RSM22DFAE	RSM22DGAE
250	250 - 275	1		RSM25DDAC		RSM25DFAC	RSM25DGAC
		2		RSM25DDAE		RSM25DFAE	RSM25DGAE
315	315 - 336	1		175733		RSM31DFAC	RSM31DGAC
		2		RSM31DDAE		RSM31DFAE	RSM31DGAE

Different sizes and tolerances: consult us
 for 2-bracket collars: consult us
 version with nbr gasket available on request



Intake fitting for under pressure installation

- Spheroidal cast iron
- For water uses

DN DERIVATION			
1"	1" 1/4	1" 1/2	2"
202208	202209	202210	202211

Complies with standard EN 545 paragraph 7.4



Blanking blade for intake collars

FOR MGD AND SLEEVES		
1" : 1" 1/4	1" 1/2 : 2"	2" 1/2 : 3"
175845	175846	202213

PER RACCORDI DI PRESA IN CARICO			
1"	1" 1/4	1" 1/2	2"
202219	202220	202221	175846



FLANGED FITTINGS

Table of contents

■ Rotatable flanged fittings	52	■ Fixed flanged fittings.....	60
Bends	53	Bends	61
Tees	55	Tees	64
Tapers.....	58	Tapers.....	68
Pipe segment	59	Bellmouth	70
		Casted pipe segment.....	70
		Casted pipe segment with puddle flange	71
		Welded pipe segment	72
		Welded pipe segment with puddle flange.....	73
		Blank flanges	74
		Reducing plate	74
		Reducing flanges.....	75
		Flange jointing material	76

Flanged fittings

■ The added value

Easy adaptation to all system configuration thanks to a complete range of fittings

Good resistance to different fluid tapes

Possible to dismantle allowing the modification and control of installation

Self-anchoring: all the pipe system elements are kept together

Easy and precise assembly

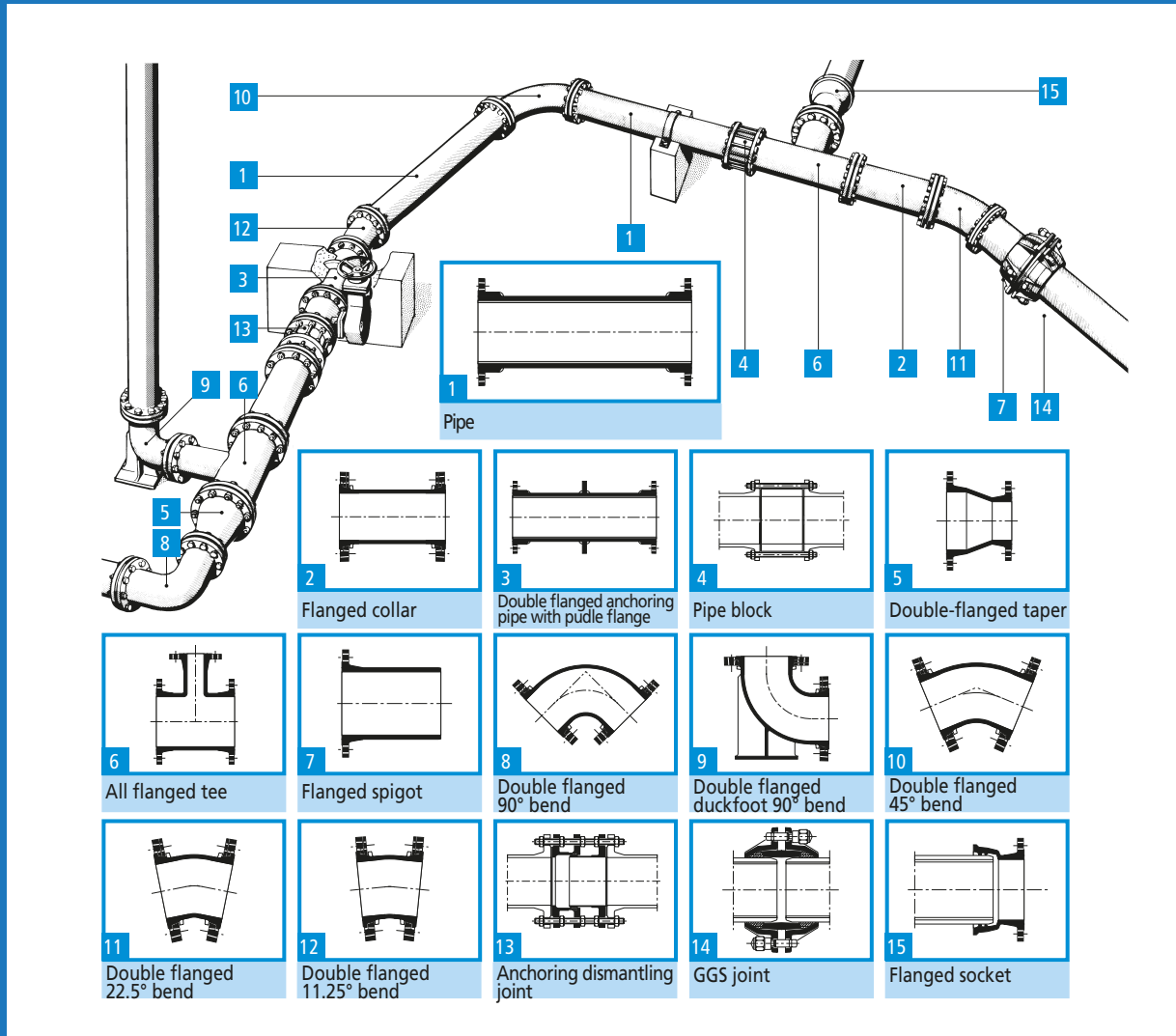

* For DN 1200 up to 2000, please consult us.

SAINT-GOBAIN PAM CANALISATION

rotatable flanged fittings, **the ideal solution for all circumstances**



VERSATILE, rotatable flanged fittings can be used for a variety of applications, both in the public utilities area and in industrial environments, for the following purposes:

- construction of network nodes whatever types of pipes are used,
- installation of valves on buried systems or in valve chambers for the shut-off or balancing of networks,
- equipment for specific systems, such as fire safety systems,
- construction of general underground or above-ground systems carrying water under pressure (for treatment plants,...).



PRACTICAL, the innovative design of the rotatable flanged fittings developed by SAINT-GOBAIN PAM CANALISATION is demonstrated in the following applications:

- construction of complex, multi-material pipe systems,
- installation of self-anchoring lengths of pipe when the construction of anchor blocks is impossible or unadvisable,
- on-line dismantling for maintenance operations, modifications or installation inspections,
- great adaptability for pre-assembly operations on site,
- connection of all types of pipes thanks to our wide range of couplings.



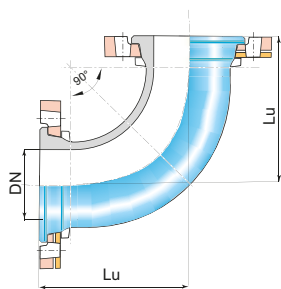

All rotatable flanged 90° bend (blue EPOXY coating)

DN	dimensions		PN 10		PN 16		PN 25		PN 40	
	Lu (mm)	weight (kg)	reference	weight (kg)	reference	weight (kg)	reference	weight (kg)	reference	
40	140	6.3	BAA40CA10TT	6.3	BAA40CA10TT	6.3	BAA40CA10TT	6.3	BAA40CA10TT	
50	150	7.3	BAA50CA10TT	7.3	BAA50CA10TT	7.3	BAA50CA10TT	7.3	BAA50CA10TT	
60	160	8.5	BAA60CA10TT	8.5	BAA60CA10TT	7.7	BAA60CA30TT	7.7	BAA60CA30TT	
65	160	9.6	BAA65CA10TT	9.6	BAA65CA10TT	9.8	Contact us	9.8	Contact us	
80	165	11.2	BAA80CA10TT	11.2	BAA80CA10TT	11.2	BAA80CA10TT	11.2	BAA80CA10TT	
100	180	13	BAB10CA10TT	13	BAB10CA10TT	14	BAB10CA30TT	14	BAB10CA30TT	
125	200	17.6	BAB12CA10TT	17.6	BAB12CA10TT	18.4	BAB12CA30TT	18.4	BAB12CA30TT	
150	220	23	BAB15CA10TT	23	BAB15CA10TT	25	BAB15CA30TT	25	BAB15CA30TT	
200	260	37.5	BAB20CA10TT	37.5	BAB20CA20TT	40.5	BAB20CA30TT	43.5	BAB20CA40TT	
250	350	59	BAB25CA10TT2	58	BAB25CA20TT2	64	BAB25CA30TT2	81.8	Contact us	
300	400	85	BAB30CA10TT2	83	BAB30CA20TT2	91	BAB30CA30TT2	122	Contact us	
350	450	121	BAB35CA10TT2	123	BAB35CA20TT2	135	BAB35CA30TT2	Please contact us		
400	500	163.5	BAB40CA10TT2	171.5	BAB40CA20TT2	190	BAB40CA30TT2			
500	600	242	BAB50CA10TT2	268	BAB50CA20TT2	280	BAB50CA30TT2			
600	700	359	BAB60CA10TT	409	BAB60CA20TT	415	BAB60CA30TT			

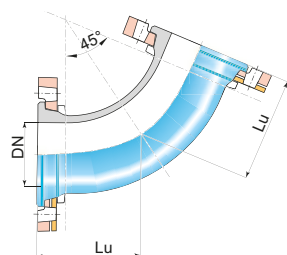

All rotatable flanged 45° bend (blue EPOXY coating)

DN	dimensions		PN 10		PN 16		PN 25		PN 40	
	Lu (mm)	weight (kg)	reference	weight (kg)	reference	weight (kg)	reference	weight (kg)	reference	
40	140	6.5	BAA40CB10TT	6.5	BAA40CB10TT	6.5	BAA40CB10TT	6.5	BAA40CB10TT	
50	150	7.6	BAA50CB10TT	7.6	BAA50CB10TT	7.6	BAA50CB10TT	7.6	BAA50CB10TT	
60	160	8.3	BAA60CB10TT	8.3	BAA60CB10TT	7.5	BAA60CB30TT	7.5	BAA60CB30TT	
65	160	9.3	BAA65CB10TT	9.3	BAA65CB10TT	9.5	BAA65CB30TT	9.5	BAA65CB30TT	
80	130	10	BAA80CB10TT	10	BAA80CB10TT	10	BAA80CB10TT	10	BAA80CB10TT	
100	140	12.1	BAB10CB10TT	12.1	BAB10CB10TT	13.6	BAB10CB30TT	13.6	BAB10CB30TT	
125	150	16.2	BAB12CB10TT	16.2	BAB12CB10TT	18	BAB12CB30TT	18	BAB12CB30TT	
150	160	21	BAB15CB10TT	21	BAB15CB10TT	23	BAB15CB30TT	23	BAB15CB30TT	
200	180	31	BAB20CB10TT	31	BAB20CB20TT	34	BAB20CB30TT	37	Contact us	
250	245	47.9	BAB25CB10TT2	47.9	BAB25CB20TT2	52.9	BAB25CB30TT2	79	Contact us	
300	275	67.5	BAB30CB10TT2	66.1	BAB30CB20TT2	73.3	BAB30CB30TT2	113	Contact us	
350	306	100	BAB35CB10TT2	102	BAB35CB20TT2	114	BAB35CB30TT2	Please contact us		
400	337	124	BAB40CB10TT2	133	BAB40CB20TT2	151	BAB40CB30TT2			
450	370	158	BAB45CB10TT2	171	BAB45CB20TT2	185	BAB45CB30TT2			
500	400	197	BAB50CB10TT2	223	BAB50CB20TT2	235	BAB50CB30TT2			
600	463	289	BAB60CB10TT2	339	BAB60CB20TT2	345	BAB60CB30TT2			

All rotatable flanged 22.30° bend (blue EPOXY coating)

DN	dimensions		PN 10		PN 16		PN 25		PN 40	
	Lu (mm)	weight (kg)	reference	weight (kg)	reference	weight (kg)	reference	weight (kg)	reference	
40	94	5.4	BAA40CD10TT	5.4	BAA40CD10TT	5.4	BAA40CD10TT	5.4	BAA40CD10TT	
50	104	6.5	BAA50CD10TT	6.5	BAA50CD10TT	6.5	BAA50CD10TT	6.5	BAA50CD10TT	
60	114	7.2	BAA60CD10TT	7.2	BAA60CD10TT	6.4	Contact us	6.4	Contact us	
65	114	8.3	BAA65CD10TT	8.3	BAA65CD10TT	—	—	—	—	
80	105	9.3	BAA80CD10TT	9.3	BAA80CD10TT	9.3	BAA80CD10TT	9.3	BAA80CD10TT	
100	110	11	BAB10CD10TT	11	BAB10CD10TT	12	BAB10CD30TT	12	BAB10CD30TT	
125	105	14	BAB12CD10TT	14	BAB12CD10TT	15.8	BAB12CD30TT	15.8	BAB12CD30TT	
150	109	18.2	BAB15CD10TT	18.2	BAB15CD10TT	20.4	BAB15CD30TT	20.4	BAB15CD30TT	
200	131	27	BAB20CD10TT	27	BAB20CD20TT	30	BAB20CD30TT	30.4	Contact us	
250	190	43.0	BAB25CD10TT2	42.2	BAB25CD20TT2	48	BAB25CD30TT2	-	-	
300	210	59.7	BAB30CD10TT2	58.3	BAB30CD20TT2	65.5	BAB30CD30TT2	89	Contact us	
350	215	84.2	BAB35CD10TT2	85.8	BAB35CD20TT2	98	BAB35CD30TT2	Please contact us		
400	237.5	92	BAB40CD10TT2	113	BAB40CD20TT2	119	BAB40CD30TT2			
450	253	128	BAB45CD10TT2	141	BAB45CD20TT2	155.4	BAB45CD30TT2			
500	272.5	143	BAB50CD10TT2	169	BAB50CD20TT2	181	BAB50CD30TT2			
600	320.5	211	BAB60CD10TT2	261	BAB60CD20TT2	268	Contact us			

All rotatable flanged 11.15° bend (blue EPOXY coating)

DN	dimensions		PN 10		PN 16		PN 25		PN 40	
	Lu (mm)	weight (kg)	reference	weight (kg)	reference	weight (kg)	reference	weight (kg)	reference	
40	99	5.6	BAA40CE10TT	5.6	BAA40CE10TT	5.6	BAA40CE10TT	5.4	BAA40CE10TT	
50	109	6.6	BAA50CE10TT	6.6	BAA50CE10TT	6.6	BAA50CE10TT	6.5	BAA50CE10TT	
60	119	7.4	BAA60CE10TT	7.4	BAA60CE10TT	6.6	Contact us	6.4	Contact us	
65	119	8.4	BAA65CE10TT	8.4	BAA65CE10TT	—	—	—	—	
80	113	9.6	BAA80CE10TT	9.6	BAA80CE10TT	9.6	BAA80CE10TT	9.3	BAA80CE10TT	
100	115	11.3	BAB10CE10TT	11.3	BAB10CE10TT	12.3	BAB10CE30TT	12	BAB10CE30TT	
125	111	14.4	BAB12CE10TT	14.4	BAB12CE10TT	15.3	BAB12CE30TT	15.8	BAB12CE30TT	
150	113	18.5	BAB15CE10TT	18.5	BAB15CE10TT	20.5	BAB15CE30TT	20.4	BAB15CE30TT	
200	132	27	BAB20CE10TT	27	BAB20CE2	30	BAB20CE30TT	30.4	Contact us	
250	165	40.7	BAB25CE10TT2	39.9	BAB25CE20TT2	45.7	BAB25CE30TT2	Please contact us		
300	175	54.9	BAB30CE10TT2	53.5	BAB30CE20TT2	60.7	BAB30CE30TT2			
350	191	80	BAB35CE10TT2	81.6	BAB35CE20TT2	93.8	BAB35CE30TT2			
400	203	85	BAB40CE10TT2	106	BAB40CE20TT2	112	BAB40CE30TT2			
450	220	120	BAB45CE10TT2	133	BAB45CE20TT2	147.4	BAB45CE30TT2			
500	232.5	131	BAB50CE10TT2	157	BAB50CE20TT2	169	BAB50CE30TT2			
600	274.5	192	BAB60CE10TT2	242	BAB60CE20TT2	248	BAB60CE30TT2			

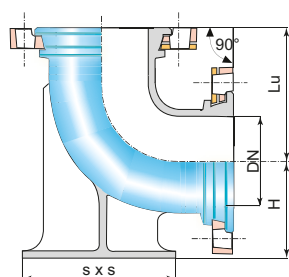

All rotatable flanged duckfoot 90° bend (blue EPOXY coating)

DN	dn	dimensions				PN 10		PN 16		PN 25		PN 40	
		Lu (mm)	h (mm)	SXS (mm)	R (mm)	weight (kg)	reference	weight (kg)	reference	weight (kg)	reference	weight (kg)	reference
40	40	140	100	160	58	8.8	BAA40CF10TT	8.8	BAA40CF1	8.8	BAA40CF10TT	8.8	BAA40CF10TT
50	50	150	100	160	58	9.9	BAA50CF10TT	9.9	BAA50CF1	9.9	BAA50CF10TT	9.9	BAA50CF10TT
60	60	160	100	160	58	10.6	BAA60CF10TT	10.6	BAA60CF1	9.8	BAA60CF10TT	9.8	Contact us
65	65	160	100	—	—	11.7	BAA65CF10TT	11.7	BAA65CF1	11.9	BAA65CF10TT	11.9	BAA65CF30TT
80	80	165	110	180	74	14	BAA80CF10TT	14	BAA80CF1	14	BAA80CF10TT	14	BAA80CF10TT
100	100	180	125	200	87	17.2	BAB10CF10TT	17.2	BAB10CF1	18.2	BAB10CF10TT	18.2	BAB10CF30TT
125	125	200	140	225	115	23	BAB12CF10TT	23	BAB12CF1	24.5	BAB12CF10TT	24.5	BAB12CF30TT
150	150	220	160	250	133	31.5	BAB15CF10TT	31.5	BAB15CF1	33.5	BAB15CF10TT	33.5	BAB15CF30TT
200	200	260	190	300	160	48	BAB20CF10TT	48	BAB20CF2	51	BAB20CF20TT	Please contact us	
250	250	350	225	350	240	85	BAB25CF10TT2	84.5	BAB25CF2	90	BAB25CF20TT2		
300	300	400	255	400	290	118.5	BAB30CF10TT2	117	BAB30CF2	124.5	BAB30CF20TT2		

All rotatable flanged tee PN 10 and PN 16 (blue EPOXY coating)

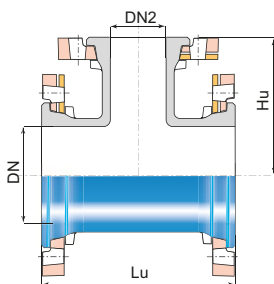

DN	dn	Dimensions		PN 10		PN 16	
		Lu (mm)	Hu (mm)	weight (kg)	reference	weight (kg)	reference
40	40	280	140	9.3	BAA40UE1ATT	9.3	BAA40UE1ATT
	50	300	140	10.4	BAA50UE1ATT	10.4	BAA50UE1ATT
50	50	300	150	10.9	BAA50UE1BTT	10.9	BAA50UE1BTT
	60	320	140	10.3	BAA60UE1ATT	10.3	BAA60UE1ATT
60	50	320	150	11.6	BAA60UE1BTT	11.6	BAA60UE1BTT
	60	320	160	12.0	BAA60UE1CTT	12.0	BAA60UE1CTT
	65	320	160	13.6	BAA65UE1DTT	13.6	BAA65UE1DTT
65	40	310	140	11.4	BAA65UE1ATT	11.4	BAA65UE1ATT
	50	320	150	12.7	BAA65UE1BTT	12.7	BAA65UE1BTT
	60	320	160	13.0	BAA65UE1CTT	13.0	BAA65UE1CTT
	65	320	160	13.6	BAA65UE1DTT	13.6	BAA65UE1DTT
80	40	330	140	13.6	BAA80UE1ATT	13.6	BAA80UE1ATT
	50	330	150	14.1	BAA80UE1BTT	14.1	BAA80UE1BTT
	60	330	160	14.3	BAA80UE1CTT	14.3	BAA80UE1CTT
	80	330	165	15.3	BAA80UE1ETT	15.3	BAA80UE1ETT
100	40	360	150	16.4	BAB10UE1ATT	16.4	BAB10UE1ATT
	50	360	160	16.9	BAB10UE1BTT	16.9	BAB10UE1BTT
	60	360	170	17.3	BAB10UE1CTT	17.3	BAB10UE1CTT
	65	360	170	17.8	BAB10UE1DTT	17.8	BAB10UE1DTT
	80	360	175	18.1	BAB10UE1ETT	18.1	BAB10UE1ETT
	100	360	180	19.0	BAB10UE1FTT	19.0	BAB10UE1FTT
125	40	400	165	21.5	BAB12UE1ATT	21.5	BAB12UE1ATT
	50	400	175	22.1	BAB12UE1BTT	22.1	BAB12UE1BTT
	60	400	185	22.5	BAB12UE1CTT	22.5	BAB12UE1CTT
	65	400	185	23.0	BAB12UE1DTT	23.0	BAB12UE1DTT
	80	400	190	23.5	BAB12UE1ETT	23.5	BAB12UE1ETT
	100	400	195	24.5	BAB12UE1FTT	24.5	BAB12UE1FTT
150	125	400	200	25.5	BAB12UE1GTT	25.5	BAB12UE1GTT
	40	440	175	29.0	BAB15UE1ATT	29.0	BAB15UE1ATT
	50	440	185	28.5	BAB15UE1BTT	28.5	BAB15UE1BTT
	60	440	195	29.0	BAB15UE1CTT	29.0	BAB15UE1CTT
	65	440	195	29.5	BAB15UE1DTT	29.5	BAB15UE1DTT
	80	440	205	30.0	BAB15UE1ETT	30.0	BAB15UE1ETT
	100	440	210	31.0	BAB15UE1FTT	31.0	BAB15UE1FTT
200	125	440	210	32.5	BAB15UE1GTT	32.5	BAB15UE1GTT
	150	440	220	35.0	BAB15UE1JTT	35.0	BAB15UE1JTT
	40	520	200	41.5	BAB20UE1ATT	41.5	BAB20UE2ATT
	50	520	210	42.0	Contact us	42.0	BAB20UE2BTT
	60	520	220	42.5	BAB20UE1CTT	42.0	BAB20UE2CTT
	65	520	220	43.0	BAB20UE1DTT	43.0	BAB20UE2DTT
	80	520	235	43.5	BAB20UE1ETT	43.5	BAB20UE2ETT
250	100	520	240	44.5	BAB20UE1FTT	44.5	BAB20UE2FTT
	125	520	240	46.0	BAB20UE1GTT	46.0	BAB20UE2GTT
	150	520	250	48.5	BAB20UE1JTT	48.0	BAB20UE2JTT
	200	520	260	52.0	BAB20UE1KTT	51.0	BAB20UE2KTT
	60	385	260	45.4	BAB25UE1CTT2	45.4	BAB25UE2CTT2
	65	360	272	52.0	Contact us	51.0	BAB25UE2DTT
300	80	405	265	46.6	BAB25UE1ETT2	46.6	BAB25UE2ETT2
	100	425	270	46.9	BAB25UV1FTT2	46.9	BAB25UV2FTT2
	150	485	280	52.4	BAB25UE1JTT2	52.4	BAB25UE2JTT2
	200	540	290	59.5	BAB25UE1KTT2	59.7	BAB25UE2KTT2
	250	600	300	67.1	BAB25UE1LTT2	67.1	BAB25UE2LTT2
350	60	405	290	37.0	BAB30UE1CTT2	37.0	BAB30UE2CTT2
	80	425	295	38.7	BAB30UE1ETT2	38.7	BAB30UE2ETT2
	100	450	300	62.5	BAB30UV1FTT2	61.5	BAB30UV2FTT2
	150	505	310	68.7	BAB30UE1JTT2	67.7	BAB30UE2JTT2
	200	565	320	77.0	BAB30UE1KTT2	76.2	BAB30UE2KTT2
	250	620	330	85.4	BAB30UE1LTT2	84.4	BAB30UE2LTT2
400	300	680	340	95.0	BAB30UE1MTT2	93.5	BAB30UE2MTT2
	60	430	320	76.9	BAB35UE1CTT2	79.2	BAB35UE2CTT2
	80	445	325	78.6	BAB35UE1ETT2	80.9	BAB35UE2ETT2
	100	470	330	81.0	BAB35UV1FTT2	83.3	BAB35UV2FTT2
	150	590	340	113.0	BAB35UE1JTT	114.0	BAB35UE2JTT
	200	585	350	97.5	BAB35UE1KTT2	100.1	BAB35UE2KTT2
	250	645	360	107.5	BAB35UE1LTT2	109.8	BAB35UE2LTT2
400	300	700	370	117.6	BAB35UE1MTT2	119.4	BAB35UE2MTT2
	350	760	380	129.6	BAB35UE1YTT2	133.0	BAB35UE2YTT2
	80	470	355	96.6	BAB40UE1ETT2	105.6	BAB40UE2ETT2
	100	490	360	104.9	BAB40UV1FTT2	114.3	BAB40UV2FTT2
	150	550	370	106.4	BAB40UE1JTT2	115.9	BAB40UE2JTT2
	200	610	380	116.5	BAB40UE1KTT2	126.2	BAB40UE2KTT2
400	250	724	390	158.0	BAB40UE1LTT	167.0	BAB40UE2LTT
	300	725	400	137.5	BAB40UE1MTT2	146.4	BAB40UE2MTT2
	400	840	420	163.0	BAB40UE1NTT2	177.2	BAB40UE2NTT2

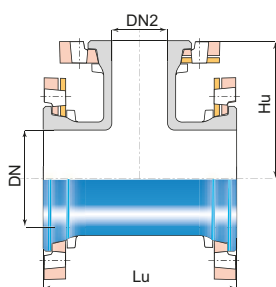

DN	dn	Dimensions		PN 10		PN 16	
		Lu (mm)	Hu (mm)	weight (kg)	reference	weight (kg)	reference
450	100	515	390	119.4	BAB45UE1FTT2	129.5	BAB45UE2FTT2
	150	620	400	144.0	BAB45UE1JTT	156.8	BAB45UE2JTT
	300	730	430	186.0	BAB45UE1MTT	196.0	BAB45UE2MTT
	400	906	450	227.0	BAB45UE1NTT	245.0	BAB45UE2NTT
	450	906	460	237.0	BAB45UE1PTT	256.0	BAB45UE2PTT
500	100	535	420	144.2	BAB50UV1FTT2	171.5	BAB50UV2FTT2
	150	590	430	153.9	BAB50UE1JTT2	181.2	BAB50UE2JTT2
	200	650	440	166.2	BAB50UE1KTT2	193.7	BAB50UE2KTT2
	250	768	450	223.0	BAB50UE1LTT	249.0	BAB50UE2LTT
	300	770	460	191.7	BAB50UE1MTT2	218.5	BAB50UE2MTT2
	400	885	480	219.5	BAB50UE1NTT2	251.5	BAB50UE2NTT2
	500	975	475	270.7	BAB50UE1QTT2	311.6	BAB50UE2QTT2
600	100	580	480	197.1	BAB60UE1FTT2	249.6	BAB60UE2FTT2
	150	640	490	210.0	BAB60UE1JTT2	262.5	BAB60UE2JTT2
	200	700	500	223.0	BAB60UV1KTT2	275.7	BAB60UV2KTT2
	300	812	520	302.8	BAB60UE1MTT	352.1	BAB60UE2MTT
	400	930	540	285.6	BAB60UE1NTT2	342.8	BAB60UE2NTT2
	500	1100	550	568.8	BAB60UE1QTT	632.0	BAB60UE2QTT
	600	1075	525	342.8	BAB60UE1RTT2	421.6	BAB60UE2RTT2

All rotatable flanged tee PN 25 and PN 40 (blue EPOXY coating)

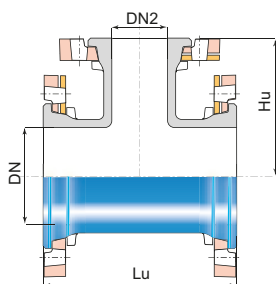

DN	dn	Dimensions		PN 25		PN 40	
		Lu (mm)	Hu (mm)	weight (kg)	reference	weight (kg)	reference
40	40	280	140	9.3	BAA40UE1ATT	9.3	BAA40UE1ATT
50	40	300	140	10.4	BAA50UE1ATT	10.4	BAA50UE1ATT
	50	300	150	10.9	BAA50UE1BTT	10.9	BAA50UE1BTT
60	40	320	140	10.3	BAA60UE3ATT	10.3	BAA60UE3ATT
	50	320	150	11.4	Contact us	11.4	Contact us
	60	320	160	10.3	BAA60UE3CTT	10.3	BAA60UE3CTT
65	40	310	140	12.3	BAA65UE3ATT	12.3	BAA65UE3ATT
	50	320	150	13.9	Contact us	13.9	Contact us
	60	320	160	13.2	Contact us	13.2	Contact us
	65	320	160	13.9	Contact us	13.9	Contact us
80	40	330	140	13.6	BAA80UE1ATT	13.6	BAA80UE1ATT
	50	330	150	14.1	BAA80UE1BTT	14.1	BAA80UE1BTT
	60	330	160	13.9	BAA80UE3CTT	13.9	BAA80UE3CTT
	80	330	165	15.3	BAA80UE1ETT	15.3	BAA80UE1ETT
100	40	360	150	17.4	BAB10UE3ATT	17.4	BAB10UE3ATT
	50	360	160	17.9	BAB10UE3BTT	17.9	BAB10UE3BTT
	60	360	170	17.9	BAB10UE3CTT	17.9	BAB10UE3CTT
	65	360	170	18.9	Contact us	18.9	Contact us
	80	360	175	19.3	BAB10UE3ETT	19.3	BAB10UE3ETT
125	100	360	180	20.5	BAB10UE3FTT	20.5	BAB10UE3FTT
	40	400	165	23.4	Contact us	23.4	Contact us
	50	400	175	24.0	BAB12UE3BTT	24.0	BAB12UE3BTT
	60	400	185	23.9	BAB12UE3CTT	23.9	BAB12UE3CTT
	65	400	185	23.1	Contact us	23.1	Contact us
	80	400	190	25.5	Contact us	25.5	Contact us
	100	400	195	26.8	BAB12UE3FTT	26.8	BAB12UE3FTT
150	125	400	200	28.2	BAB12UE3GTT	28.2	BAB12UE3GTT
	40	440	175	30.0	BAB15UE3ATT	30.0	BAB15UE3ATT
	50	440	185	30.5	Contact us	30.5	Contact us
	60	440	195	30.5	BAB15UE3CTT	30.5	BAB15UE3CTT
	65	440	195	29.5	BAB15UE3DTT	31.5	BAB15UE3DTT
	80	440	205	32.0	BAB15UE3ETT	32.0	BAB15UE3ETT
	100	440	210	33.5	BAB15UE3FTT	33.5	BAB15UE3FTT
200	125	440	210	35.5	BAB15UE3GTT	35.5	BAB15UE3GTT
	150	440	220	38.0	BAB15UE3JTT	38.0	BAB15UE3JTT
	40	520	200	43.8	BAB20UE3ATT	47.8	BAB20UE4ATT
	50	520	210	45.0	Contact us	48.6	BAB20UE4BTT
	60	520	220	45.0	BAB20UE3CTT	48.0	Contact us
	65	520	220	45.0	BAB20UE3DTT	51.0	Contact us
	80	520	235	46.5	BAB20UE3ETT	51.0	Contact us
200	100	520	240	48.0	BAB20UE3FTT	52.0	Contact us
	125	520	240	50.0	Contact us	-	Contact us
	150	520	250	52.1	BAB20UE3JTT	56.0	BAB20UE4JTT
	200	520	260	55.5	BAB20UE3KTT	57.4	BAB20UE4KTT

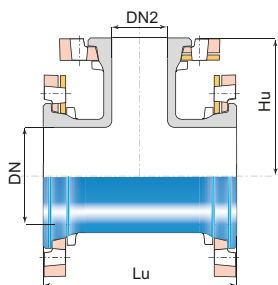

DN	dn	Dimensions		PN 25		PN 40	
		Lu (mm)	Hu (mm)	weight (kg)	reference	weight (kg)	reference
250	60	385	260	52.2	BAB25UE3CTT2	-	Contact us
	65	360	272	56.0	Contact us	78.5	
	80	405	265	53.4	BAB25UE3ETT2	-	
	100	425	270	53.4	BAB25UV3FTT2	-	
	150	485	280	59.6	BAB25UE3JTT2	-	
	200	540	290	66.2	BAB25UE3KTT2	-	
	250	600	300	74.9	BAB25UE3LTT2	-	
300	60	405	290	37.0	BAB30UE3CTT2	-	Contact us
	80	425	295	38.7	BAB30UE3ETT2	-	
	100	450	300	70.4	BAB30UV3FTT2	-	
	150	505	310	77.3	BAB30UE3JTT2	-	
	200	565	320	85.1	BAB30UE3KTT2	-	
	250	620	330	94.6	BAB30UE3LTT2	-	
	300	680	340	104.9	BAB30UE3MTT2	-	
350	60	430	320	91.0	BAB35UE3CTT2	-	Contact us
	80	445	325	92.7	BAB35UE3ETT2	-	
	100	470	330	96.4	BAB35UV3FTT2	-	
	150	590	340	128.0	BAB35UE3JTT	-	
	200	585	350	113.2	BAB35UE3KTT2	-	
	250	645	360	124.3	BAB35UE3LTT2	-	
	300	700	370	135.1	BAB35UE3MTT2	-	
400	350	760	380	150.7	BAB35UE3YTT2	-	Contact us
	80	470	355	123.6	BAB40UE3ETT2	-	
	100	490	360	134.6	BAB40UV3FTT2	-	
	150	550	370	136.9	BAB40UE3JTT2	-	
	200	610	380	146.4	BAB40UE3KTT2	-	
	250	724	390	187.0	BAB40UE3LTT	-	
	300	725	400	169.3	BAB40UE3MTT2	-	
450	400	840	420	205.5	BAB40UE3NTT2	-	Contact us
	100	515	390	151.3	BAB45UE3FTT2	-	
	150	620	400	172.2	BAB45UE3JTT	-	
	300	730	430	218.8	Contact us	-	
	400	906	450	-	Contact us	-	
500	450	906	460	277.8	BAB45UE3PTT	-	Contact us
	100	535	420	185.5	BAB50UV3FTT2	-	
	150	590	430	195.9	BAB50UE3JTT2	-	
	200	650	440	207.7	BAB50UE3KTT2	-	
	250	768	450	263.0	Contact us	-	
	300	770	460	235.1	Contact us	-	
	400	885	480	273.5	BAB50UE3NTT2	-	
600	500	975	475	329.6	BAB50UE2QTT2	-	Contact us
	100	580	480	257.3	BAB60UE3FTT2	-	
	150	640	490	270.9	BAB60UE3JTT2	-	
	200	700	500	283.4	BAB60UV3KTT2	-	
	300	812	520	362.0	BAB60UE3MTT	-	
	400	930	540	358.6	BAB60UE3NTT2	-	
	500	1100	550	644.0	BAB60UE3QTT	-	
600	1075	525	431.0	BAB60UE3RTT2	-		

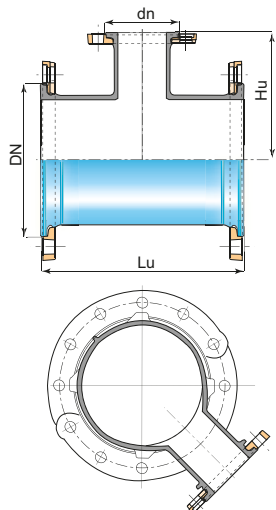

All rotatable flanged washout tee (blue EPOXY coating)

DN	dn	Lu mm	hu mm	(kg)	PN 10 reference	(kg)	PN 16 reference	(kg)	PN 25 reference	(kg)	PN 40 reference
250	100	430	270	51.7	BAB25UV1FTT2	50.9	BAB25UV2FTT2	56.7	BAB25UV3FTT2	81.3	Contact us
300	100	450	300	68.4	BAB30UV1FTT2	67	BAB30UV2FTT2	74.3	BAB30UV3FTT2	120	Contact us
350	100	470	330	97	BAB35UV1FTT2	98	BAB35UV2FTT2	111	BAB35UV3FTT2	Please contact us	
400	100	490	360	114	BAB40UV1FTT2	123	BAB40UV2FTT2	141	BAB40UV3FTT2		
500	100	533	420	168	BAB50UV1FTT2	194	BAB50UV2FTT2	206	BAB50UV3FTT2		
600	200	700	500	265	BAB60UV1KTT2	315	BAB60UV2KTT2	322	BAB60UV3KTT2		

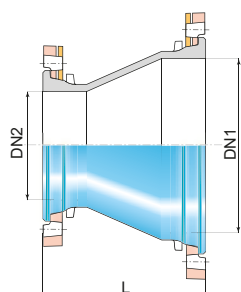

All rotatable flanged taper (blue EPOXY coating)

DN (mm)	Dimensions			PN 10		PN 16		PN 25		PN 40	
	dn (mm)	L (mm)	weight (kg)	reference	weight (kg)	reference	weight (kg)	reference	weight (kg)	reference	
60	40	200.0	7.3	BAA60VE1ATT	7.3	BAA60VE1ATT	6.9	BAA60VE3ATT	6.9	BAA60VE3ATT	
	50	216.0	8.3	BAA60VE1BTT	8.3	BAA60VE1BTT	7.9	BAA60VE3BTT	7.9	BAA60VE3BTT	
65	40	200.0	7.9	BAA65VE1ATT	7.9	BAA65VE1ATT	8.1	Contact us	8.1	Contact us	
	50	216.0	7.3	BAA65VE1BTT	7.3	BAA65VE1BTT	7.3	Contact us	7.3	Contact us	
80	40	200.0	7.9	BAA80VE1ATT	7.9	BAA80VE1ATT	7.9	BAA80VE1ATT	7.9	BAA80VE1ATT	
	50	251.0	8.4	BAA80VE1BTT	8.4	BAA80VE1BTT	8.4	BAA80VE1BTT	8.4	BAA80VE1BTT	
	60	200.0	8.8	BAA80VE1CTT	8.8	BAA80VE1CTT	7.9	BAA80VE3CTT	7.9	BAA80VE3CTT	
	65	200.0	9.3	BAA80VE1DTT	9.3	BAA80VE1DTT	9.4	BAA80VE3DTT	9.4	BAA80VE3DTT	
100	40	200.0	8.7	BAB10VE1ATT	8.7	BAB10VE1ATT	8.9	Contact us	8.9	Contact us	
	50	249.0	9.2	BAB10VE1BTT	9.2	BAB10VE1BTT	9.7	BAB10VE3BTT	9.7	BAB10VE3BTT	
	60	200.0	9.6	BAB10VE1CTT	9.6	BAB10VE1CTT	9.7	BAB10VE3CTT	9.7	BAB10VE3CTT	
	65	200.0	10.1	BAB10VE1DTT	10.1	BAB10VE1DTT	11.7	BAB10VE3DTT	11.7	BAB10VE3DTT	
125	80	200.0	10.7	BAB10VE1ETT	10.7	BAB10VE1ETT	11.2	BAB10VE3ETT	11.2	BAB10VE3ETT	
	40	280.5	11.1	BAB12VE1ATT	11.1	BAB12VE1ATT	-	Contact us	-	Contact us	
	50	290.5	11.6	BAB12VE1BTT	11.6	BAB12VE1BTT	12.5	Contact us	12.5	Contact us	
	60	300.0	12.0	BAB12VE1CTT	12.0	BAB12VE1CTT	12.5	BAB12VE3CTT	12.5	BAB12VE3CTT	
	65	300.0	11.4	BAB12VE1DTT	11.4	BAB12VE1DTT	13.0	Contact us	13.0	Contact us	
	80	200.0	12.5	BAB12VE1ETT	12.5	BAB12VE1ETT	12.9	BAB12VE3ETT	12.9	BAB12VE3ETT	
150	100	200.0	13.1	BAB12VE1FTT	13.1	BAB12VE1FTT	14.5	BAB12VE3FTT	14.5	BAB12VE3FTT	
	40	331.5	14.2	BAB15VE1ATT	14.2	BAB15VE1ATT	15.2	Contact us	15.2	Contact us	
	50	341.5	14.7	BAB15VE1BTT	14.7	BAB15VE1BTT	15.7	Contact us	15.7	Contact us	
	60	351.6	15.1	BAB15VE1CTT	15.1	BAB15VE1CTT	15.7	BAB15VE3CTT	15.7	BAB15VE3CTT	
	65	351.5	15.6	BAB15VE1DTT	15.6	BAB15VE1DTT	15.7	Contact us	15.7	Contact us	
	80	311.0	15.6	BAB15VE1ETT	15.6	BAB15VE1ETT	16.6	Contact us	16.6	Contact us	
200	100	306.0	15.7	BAB15VE1FTT	15.7	BAB15VE1FTT	17.2	BAB15VE3FTT	17.2	BAB15VE3FTT	
	125	200.0	16.7	BAB15VE1GTT	16.7	BAB15VE1GTT	18.6	BAB15VE3GTT	18.6	BAB15VE3GTT	
	100	385.0	22.8	BAB20VE1FTT	22.7	BAB20VE2FTT	24.7	BAB20VE3FTT	25.1	BAB20VE4FTT	
250	125	326.5	23.1	BAB20VE1GTT	23.0	BAB20VE2GTT	25.4	BAB20VE3GTT	25.8	BAB20VE4GTT	
	150	304.0	23.5	BAB20VE1JTT	23.5	BAB20VE2JTT	26.0	BAB20VE3JTT	26.4	BAB20VE4JTT	
	125	370.0	28.8	BAB25VE1GTT2	28.8	BAB25VE2GTT2	33.5	BAB25VE3GTT2	-	Contact us	
250	150	319.0	28.8	BAB25VE1JTT2	28.8	BAB25VE2JTT2	34.2	BAB25VE3JTT2	-	Contact us	
	200	250.0	30.9	BAB25VE1KTT2	31.1	BAB25VE2KTT2	35.8	BAB25VE3KTT2	-	Contact us	

Short double flanged pipes (blue EPOXY coating)

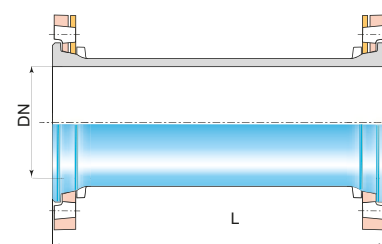

Dimensions		weight (kg)	PN 10		PN 16		PN 25		PN 40	
DN (mm)	L (mm)		reference	weight (kg)	reference	weight (kg)	reference	weight (kg)	reference	
60	250	6.6	BAA60MT1ATT	6.6	BAA60MT1ATT	6.6	BAA60MT3ATT	6.6	BAA60MT3ATT	
60	500	10.4	BAA60MT1BTT	10.4	BAA60MT1BTT	9.4	BAA60MT3BTT	9.4	BAA60MT3BTT	
65	250	8.4	BAA65MT1ATT	8.4	BAA65MT1ATT	8.6	Consult us	8.6	Consult us	
65	500	11.2	BAA65MT1BTT	11.2	BAA65MT1BTT	11.4	BAA65MT3TT	11.4	BAA65MT3BTT	
80	250	9.8	BAA80MT1ATT	9.8	BAA80MT1ATT	9.8	BAA80MT1ATT	9.8	BAA80MT1ATT	
80	500	13.3	BAA80MT1BTT	13.3	BAA80MT1BTT	13.3	BAA80MT1BTT	13.3	BAA80MT1BTT	
100	250	11.5	BAB10MT1ATT	11.5	BAB10MT1ATT	12.5	BAB10MT3ATT	12.5	BAB10MT3ATT	
100	500	13.4	BAB10MT1BTT	13.4	BAB10MT1BTT	14.4	BAB10MT3BTT	14.4	BAB10MT3BTT	
125	250	15	BAB12MT1ATT	15	BAB12MT1ATT	16.7	BAB12MT3ATT	16.7	BAB12MT3ATT	
125	500	20.5	BAB12MT1BTT	20.5	BAB12MT1BTT	21.4	Consult us	21.4	Consult us	
150	250	19	BAB15MT1ATT	19	BAB15MT1ATT	21	BAB15MT3ATT	21	BAB15MT3ATT	
150	500	26	BAB15MT1BTT	26	BAB15MT1BTT	28	BAB15MT3BTT	28	BAB15MT3BTT	
200	250	26.5	BAB20MT1ATT	26	BAB20MT2ATT	29	BAB20MT3ATT	30.1	BAB20MT4ATT	
200	500	36.5	BAB20MT1BTT	36	BAB20MT2BTT	39.5	BAB20MT3BTT	42	Consult us	
250	250	38.5	BAB25MT1ATT2	38	BAB25MT2ATT2	43.5	BAB25MT3ATT2	64	Consult us	
250	500	54	BAB25MT1BTT2	53	BAB25MT2BTT2	59	BAB25MT3BTT2	79	Consult us	
300	250	50	BAB30MT1ATT2	49	BAB30MT2ATT2	56	BAB30MT3ATT2	80	Consult us	
300	500	69.5	BAB30MT1BTT2	68.5	BAB30MT2BTT2	75.5	BAB30MT3BTT2	106	Consult us	
350	250	69.2	BAB35MT1ATT2	70.8	BAB35MT2ATT2	83	BAB35MT3ATT2	Please contact us		
350	500	98.7	BAB35MT1BTT2	100.3	BAB35MT2BTT2	112.5	BAB35MT3BTT2			
400	250	69.1	BAB40MT1ATT	77.1	BAB40MT2ATT	95.5	BAB40MT3ATT2			
400	500	113.7	BAB40MT1BTT2	122.7	BAB40MT2BTT2	140.7	BAB40MT3BTT2			
450	250	85	BAB45MT1ATT	98	Consult us	115	Consult us			
450	500	114.5	BAB45MT1BTT	127.5	BAB45MT2BTT	143.5	Consult us			
500*	250	113	BBB50MT1ATT	118.6	BBB50MT2ATT	147	Consult us			
500*	500	162.6	BBB50MT1BTT	167.8	BBB50MT2BTT	196	BBB50MT3BTT			
600*	250	153.8	Consult us	169.9	BBB60MT2ATT	209	Consult us			
600*	500	219.5	BBB60MT1BTT	235.7	BBB60MT2BTT	274	BBB60MT3BTT			

* Only available with fixed flanges.

Flanged spigot (blue EPOXY coating)

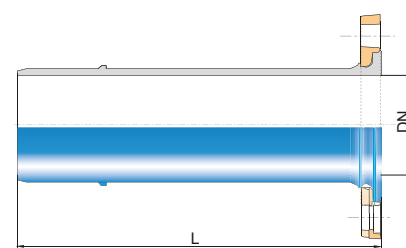

Dimensions		weight (kg)	PN 10		PN 16		PN 25		PN 40	
DN (mm)	L (mm)		reference	weight (kg)	reference	weight (kg)	reference	weight (kg)	reference	
60	350	6	SEA60BU10TT	6	SEA60BU10TT	5.6	Consult us	5.6	Consult us	
80	350	8	SEA80BU10TT	8	SEA80BU10TT	8	SEA80BU10TT	8	SEA80BU10TT	
100	350	8.56	SEB10BU10TT	8.56	SEB10BU10TT	6.5	SEB10BU30TT	6.5	SEB10BU30TT	
125	350	10.88	Consult us	10.88	Consult us	8.6	SEB12BU30TT	8.6	SEB12BU30TT	
150	400	13.96	SEB15BU10TT	13.96	SEB15BU10TT	14.96	Consult us	14.96	Consult us	
200	400	20.6	SEB20BU10TT	20.5	SEB20BU20TT	22	Consult us	22.4	SEB20BU40TT	
250	400	34	SEB25BU10TT	33.5	SEB25BU20TT	32.02	Consult us	—	—	
300	450	46.8	SEB30BU10TT	46.1	SEB30BU20TT	41.62	Consult us	69	Consult us	
350	450	58.6	SEB35BU10TT2	59.4	SEB35BU20TT2	65.5	SEB35BU30TT2	Please contact us		
400	480	70	SEB40BU10TT2	74	SEB40BU20TT2	83	SEB40BU30TT2			
450	500	86	SEB45BU10TT2	92	SEB45BU20TT2	100	SEB45BU30TT2			
500	520	104	SEB50BU10TT2	117	SEB50BU20TT2	123	SEB50BU30TT2			
600	560	144	SEB60BU10TT2	169.5	SEB60BU20TT2	172	SEB60BU30TT2			

SAINT-GOBAIN PAM CANALISATION

fixed flanged fittings, the ideal solution for all circumstances



ADAPTABLE, fixed flanged fittings can be used for a variety of applications, both for public utilities area and in industrial environments, for the following purposes:

- construction of network nodes whatever type of pipe is used,
- installation of valves on buried systems or in valve chambers for the shut-off or balancing of networks,
- equipment for specific systems, such as fire safety systems,
- construction of general underground or above-ground systems carrying water under pressure (for treatment plants, etc.).

PRACTICAL, fixed flanged fittings developed by SAINT-GOBAIN PAM CANALISATION show flexibility in installations as demonstrated in the following applications:

- construction of complex, multi-material pipe systems,
- installation of self-anchoring lengths of pipe when the construction of anchor blocks is impossible or unadvisable,
- on-line dismantling for maintenance operations, modifications or installation inspections,
- great adaptability for pre-assembly operations on site,
- connection of all types of pipes thanks to our wide range of couplings.

Buried fittings are subjected to a variety of attack, including soil and backfill corrosivity. PAM fixed flanged fittings have an epoxy coating which provides a high level of corrosion resistance in most applications, including highly aggressive conditions.

The epoxy coating, in compliance with EN 14901, on all the internal and external surfaces of fixed flanged fittings provides reinforced protection against impact and aggressive effects of the environment or the fluid conveyed.

All fixed flanged 90° bend (blue epoxy coating in compliance with EN 14901)

Available on request.

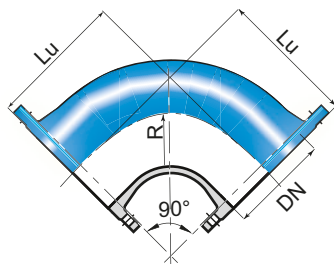

DN	dimensions		PN 10		PN 16		PN 25		PN 40	
	Lu (mm)	R (mm)	weight (kg)	reference	weight (kg)	reference	weight (kg)	reference	weight (kg)	reference
50	150	110	6.4	BBA50CA10TT	6.4	BBA50CA10TT	6.4	BBA50CA10TT	6.4	BBA50CA10TT
80	165	122	9.7	BBA80CA10TT	9.7	BBA80CA10TT	9.7	BBA80CA10TT	9.7	BBA80CA10TT
100	180	135	12	BBB10CA10TT	12	BBB10CA10TT	13.0	BBB10CA30TT	13.0	BBB10CA30TT
125	200	152.5	15.5	BBB12CA10TT	15.5	BBB12CA10TT	-	-	-	-
150	220	170	22.6	BBB15CA10TT	22.6	BBB15CA10TT	22.0	BBB15CA30TT	22.0	BBB15CA30TT
200	260	205	31	BBB20CA10TT	31.0	BBB20CA20TT	34.5	BBB20CA30TT	-	-
250	350	290	49.9	BBB25CA10TT	49.9	BBB25CA20TT	57.0	BBB30CA30TT	-	-
300	400	335	66	BBB30CA10TT	69.5	BBB30CA20TT	74.5	BBB30CA30TT	-	-
350	450	350	104	BBB35CA10TT	96	BBB35CA20TT	112.6	BBB35CA30TT	-	-
400	500	400	120.9	BBB40CA10TT	120.9	BBB40CA20TT	164.0	BBB40CA30TT	-	-
450	550	452	221	BBB45CA10TT	221	BBB45CA20TT	189.7	BBB45CA30TT	-	-
500	600	495	265	BBB50CA10TT	287	BBB50CA20TT	287.0	BBB50CA30TT	-	-
600	700	581	431	BBB60CA10TT	431	BBB60CA20TT	-	-	-	-
700	800	695	564	BBB70CA10TT	561	BBB70CA20TT	-	-	-	-
800	900	785	782	BBB80CA10TT	778	BBB80CA20TT	-	BB80CA30TT	-	-
900	1000	875	1030	BBB90CA10TT	1025	BBB90CA20TT	1154.0	BBB90CA30TT	-	-
1000	1100	965	1354	BBC10CA10TT	1348	BBC10CA20TT	-	-	-	-
1200	1355	1200	2552	BBC12CA10TT	2625	BBC12CA20TT	2745.00	BBC12CA30TT	-	-

All fixed flanged 45° bend (blue epoxy coating in compliance with EN 14901)

Available on request.

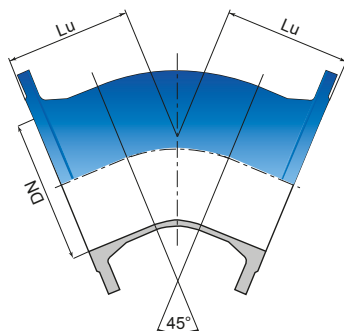

DN	dimensions		PN 10		PN 16		PN 25		PN 40	
	Lu (mm)	R (mm)	weight (kg)	reference	weight (kg)	reference	weight (kg)	reference	weight (kg)	reference
80	130	210	10.8	BBA80CB10TT	10.8	BBA80CB10TT	10.8	BBA80CB10TT	10.8	BBA80CB10TT
100	140	229.3	11.3	BBB10CB10TT	11.3	BBB10CB10TT	11.5	BBB10CB30TT	11.5	BBB10CB30TT
125	150	247.5	14.6	BBB12CB10TT	14.6	BBB12CB10TT	16	BBB12CB30TT	16	BBB12CB30TT
150	160	265.6	18.7	BBB15CB10TT	18.7	BBB15CB10TT	20.5	BBB15CB30TT	20.5	BBB15CB30TT
200	180	301.8	29.5	BBB20CB10TT	27.5	BBB20CB20TT	30	BBB20CB30TT	-	-
250	350	296	54.5	BBB25CB10TT	52	BBB25CB20TT	54	BBB25CB30TT	-	BBB25CB40TT
300	400	346	80.5	BBB30CB10TT	74	BBB30CB20TT	87.2	BBB30CB30TT	-	-
350	298	334	96	BBB35CB10TT	82	BBB35CB20TT	115.5	BBB35CB30TT	-	-
400	326	351	94	BBB40CB10TT	102	BBB40CB20TT	-	BBB40CB30TT	-	BBB40CB40TT
450	350	407	158	BBB45CB10TT	132	BBB45CB20TT	-	-	-	-
500	375	501	145	BBB50CB10TT	174	BBB50CB20TT	-	-	-	BBB50CB40TT
600	426	799	212	BBB60CB10TT	264	BBB60CB20TT	292.4	BBB60CB30TT	-	BBB60CB40TT
700	478	725	341	BBB70CB10TT	338	BBB70CB20TT	-	BBB70CB30TT	-	-
800	529	809	452	BBB80CB10TT	448	BBB80CB20TT	-	-	-	-
900	581	894	519	BBB90CB10TT	587	BBB90CB20TT	-	-	-	-
1000	632	976	670	BBC10CB10TT	771	BBC10CB20TT	-	-	-	-
1200	746		1028	BBC12CB10TT	1171	BBC12CB20TT	1367	BBC12CB30TT	-	-
1400	782		1667	BBC14CB10TT	1772	BBC14CB20TT	-	-	-	-
1500	782		-	-	1950	BBC15CB20TT	-	-	-	-
1600	843		2279	BBC16CB10TT	2446	BBC16CB20TT	-	-	-	-
1800	905									
2000	980		3574	BBC20CB10TT	-	-	-	-	-	-

All fixed flanged 22.30° bend (blue epoxy coating in compliance with EN 14901)

Available on request.

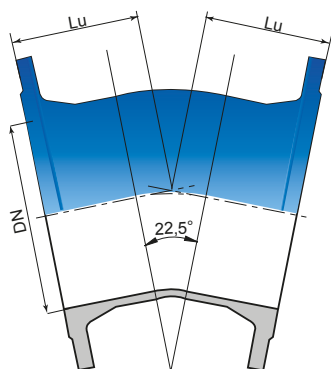

DN	dimensions		PN 10		PN 16		PN 25		PN 40	
	Lu (mm)	weight (kg)	reference	weight (kg)	reference	weight (kg)	reference	weight (kg)	reference	
80	100	11	BBA80CD10TT	11	BBA80CD10TT	11	BBA80CD10TT	11	BBA80CD10TT	
100	110	11	BBB10CD10TT	11	BBB10CD10TT	18	BBB10CD30TT	18	BBB10CD30TT	
150	109	28	BBB15CD10TT	28	BBB15CD10TT	21.5	BBB15CD30TT	21.5	BBB15CD30TT	
200	138	41	BBB20CD10TT	41	BBB20CD20TT	30	BBB20CD30TT	-	-	
250	190	47.5	BBB25CD10TT	56	BBB25CD20TT	48.8	BBB25CD30TT	-	-	
300	210	73	BBB30CD10TT	73	BBB30CD20TT	69.5	BBB30CD30TT	-	-	
350	210	75	BBB35CD10TT	83	BBB35CD20TT	91.5	BBB35CD30TT	-	-	
400	239	98.5	BBB40CD10TT	107	BBB40CD20TT	131	BBB40CD30TT	-	BBB40CD30TT	
450	349	120	Contact us	135	BBB45CD20TT	-	-	-	-	
500	375	210	BBB50CD10TT	210	BBB50CD20TT	199.4	BBB50CD30TT	-	-	
600	426	219	BBB60CD10TT	267	BBB60CD20TT	-	-	-	-	
700	300	261	BBB70CD10TT	258	BBB70CD20TT	-	BBB70CD30TT	-	-	
800	335	340	BBB80CD10TT	336	BBB80CD20TT	-	-	-	-	
900	375	442	BBB90CD10TT	437	BBB90CD20TT	-	BBB90CD30TT	-	-	
1000	410	587	BBC10CD10TT	581	BBC10CD20TT	-	BBC10CD30TT	-	-	
1200	467.5	905	BBC12CD10TT	1018	BBC12CD20TT	-	-	-	-	
1400	524	-	BBC14CD10TT	1324	BBC14CD20TT	-	-	-	-	
1600	564	-	-	1836	BBC16CD20TT	-	-	-	-	
1800	600	-	-	-	-	-	-	-	-	
2000	650	-	-	-	-	-	-	-	-	

Please contact us

All fixed flanged 11.15° bend (blue epoxy coating in compliance with EN 14901)

Available on request.

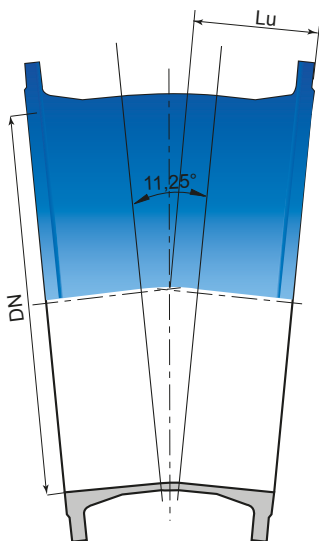

DN	dimensions		weight (kg)	PN 10		PN 16		PN 25		PN 40	
	Lu (mm)	R (mm)		reference	weight (kg)	reference	weight (kg)	reference	weight (kg)	reference	
80	113	233	8.8	BBA80CE10TT	8.8	BBA80CE10TT	8.8	BBA80CE10TT	8.8	BBA80CE10TT	
100	115	228	16	BBB10CE10TT	16	BBB10CE10TT	11.9	BBB10CE30TT	11.9	BBB10CE30TT	
150	113	274	19	BBB15CE10TT	19	BBB15CE10TT	18.5	BBB15CE30TT	18.5	BBB15CE30TT	
200	132	324	36	BBB20CE10TT	36	BBB20CE20TT	31.5	BBB20CE30TT	-	-	
250	165	382	50	BBB25CE10TT	49	BBB25CE20TT	-	-	-	-	
300	175	220	62	BBB30CE10TT	62	BBB30CE20TT	63	BBB30CE30TT	-	-	
350	190	266	74	BBB35CE10TT	74	BBB35CE20TT	-	-	-	-	
400	205	326	116	BBB40CE10TT	116	BBB40CE20TT	131	BBB40CE30TT	-	BBB40CE30TT	
450	349	2507	126.1	BBB45CE10TT	135	BBB45CE20TT	-	-	-	-	
500	375	2994.8	179	BBB50CE10TT	179	BBB50CE20TT	200.4	BBB50CE30TT	-	BBB50CE30TT	
600	426	426	192	BBB60CE10TT	268	BBB60CE20TT	-	BBB60CE30TT	-	-	
700	230	533	227	BBB70CE10TT	223	BBB70CE20TT	-	-	-	-	
800	255	624	290	BBB80CE10TT	286	BBB80CE20TT	-	BBB80CE30TT	-	-	
900	280	705	368	BBB90CE10TT	363	BBB90CE20TT	-	BBB90CE30TT	-	-	
1000	310	837	488	BBC10CE10TT	482	BBC10CE20TT	-	BBC10CE30TT	-	-	
1200	346	1117	745	BBC12CE10TT	858	BBC12CE20TT	1024	BBC12CE30TT	-	-	
1400	403	-	996	BBC14CE10TT	-	-	-	-	-	-	
1600	433	-	-	-	1530	BBC16CE20TT	-	-	-	-	
1800	463	-	-	-	-	-	-	-	-	-	
2000	495	-	-	-	-	-	-	-	-	-	

Please contact us

All fixed flanged long radius bend (blue epoxy coating in compliance with EN 14901)

Available on request.

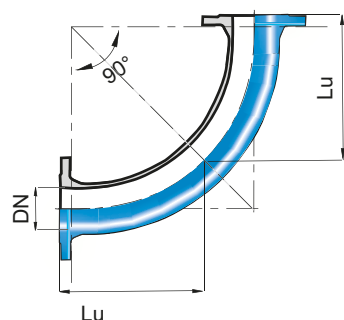

DN	dimensions		PN 16	
	Lu (mm)	weight (kg)	reference	
80	380	13.8	BBA80CH10TT	
100	400	18	BBB10CH10TT	
150	450	30	BBB15CH10TT	
200	500	45.5	BBB20CH20TT	
250	550	65	BBB25CH20TT	
300	600	89.5	BBB30CH20TT	
350	650	121	BBB35CH20TT	
400	700	157	BBB40CH20TT	
450	750	197	BBB45CH20TT	
500	800	252	BBB50CH20TT	
600	900	379	BBB60CH20TT	

* PN 25 and PN 40 please contact us.

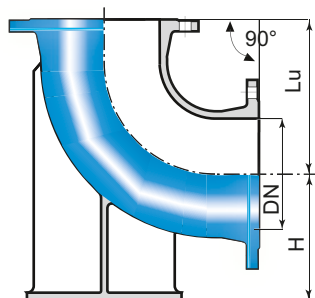

All fixed flanged duckfoot 90° bend (blue epoxy coating in compliance with EN 14901)

Available on request.

DN	dimensions		PN 10		PN 16	
	Lu (mm)	h (mm)	weight (kg)	reference	weight (kg)	reference
80	165	110	14.1	BBA80CF10TT	14.1	BBA80CF10TT
100	180	125	16.9	BBB10CF10TT	16.9	BBB10CF10TT
125	200	140	24	BBB12CF10TT	24	BBB12CF10TT
150	220	160	31.5	BBB15CF10TT	31.5	BBB15CF10TT
200	260	190	44	BBB20CF10TT	43.5	BBB20CF20TT
250	350	225	71	BBB25CF10TT	71	BBB25CF20TT
300	400	255	102	BBB30CF10TT	102	BBB30CF20TT
350	450	294	165	BBB35CF10TT	165	BBB35CF20TT
400	500	324	218	BBB40CF10TT	183	BBB40CF20TT
450	550	355	285	BBB45CF10TT	289	BBB45CF20TT
500	600	389	349	BBB50CF10TT	373	BBB50CF20TT
600	700	455	525	BBB60CF10TT	569	BBB60CF20TT
700	800	520	730	BBB70CF10TT	746	BBB70CF20TT
800	900	590	1026	BBB80CF10TT	1003	BBB80CF20TT
900	1000	645	1809	BBB90CF10TT	1751	BBB90CF20TT
1000	1100	710	2365	BBC10CF10TT	2303	BBC10CF20TT
1200	1355	840	4073	BBC12CF10TT	4146	BBC12CF20TT

* PN 25 and PN 40 please contact us.

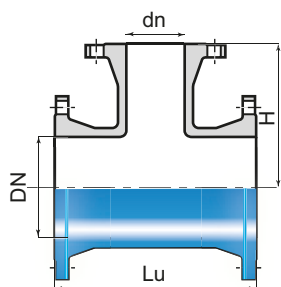

All fixed flanged tee (blue epoxy coating in compliance with EN 14901)

Available on request.

DN	dn	dimensions		PN 10		PN 16	
		Lu (mm)	Hu (mm)	weight (kg)	reference	weight (kg)	reference
80	50	320	156	13.9	BBA80TE1BTT	13.9	BBA80TE1BTT
	80	330	165	15.3	BBA80TE1ETT	15.3	BBA80TE1ETT
100	50	369	185	17.1	BBB10TE1BTT	17.1	BBB10TE1BTT
	80	360	175	18.4	BBB10TE1ETT	18.4	BBB10TE1ETT
	100	360	180	19	BBB10TE1FTT	19	BBB10TE1FTT
125	80	400	190	23	BBB12TE1ETT	23	BBB12TE1ETT
	100	400	195	23.8	BBB12TE1FTT	23.8	BBB12TE1FTT
	125	400	200	25	BBB12TE1GTT	25	BBB12TE1GTT
150	50	444	213	30.5	BBB15TE1BTT	30.5	BBB15TE1BTT
	80	440	205	28.5	BBB15TE1ETT	28.5	BBB15TE1ETT
	100	440	210	29.5	BBB15TE1FTT	29.5	BBB15TE1FTT
	125	440	215	31	BBB15TE1GTT	31	BBB15TE1GTT
	150	440	220	32.5	BBB15TE1JTT	32.5	BBB15TE1JTT
200	80	520	235	44.3	BBB20TE1ETT	32.8	BBB20TE2ETT
	100	520	240	43	BBB20TE1FTT	43	BBB20TE2FTT
	150	520	250	46	BBB20TE1JTT	48	BBB20TE2JTT
	200	520	260	49.5	BBB20TE1KTT	49.1	BBB20TE2KTT
250	80	700	265	67.5	BBB25TE1ETT	66.5	BBB25TE2ETT
	100	700	275	67	BBB25TE1FTT	67	BBB25TE2FTT
	150	700	300	72	BBB25TE1JTT	72	BBB25TE2JTT
	200	700	325	75	BBB25TE1KTT	73	BBB25TE2KTT
	250	700	350	81	BBB25TE1LTT	80	BBB25TE2LTT
300	100	800	300	94	BBB30TE1FTT	93	BBB30TE2FTT
	150	800	325	98	BBB30TE1JTT	97	BBB30TE2JTT
	200	800	350	103	BBB30TE1KTT	93	BBB30TE2KTT
	250	800	380	109	BBB30TE1LTT	108	BBB30TE2LTT
	300	800	400	114	BBB30TE1MTT	109.6	BBB30TE2MTT
350	100	850	325	Please contact us		122	BBB35TE2FTT
	150	850	325			123	BBB35TE2JTT
	200	850	325			141.5	BBB35TE2KTT
	250	850	325			132	BBB35TE2LTT
	300	850	425			144	BBB35TE2MTT
	350	850	425			153	BBB35TE2YTT
400	100	900	350	144	BBB40TE1FTT	154	BBB40TE2FTT
	150	900	350	148	BBB40TE1JTT	155	BBB40TE2JTT
	200	900	350	125.4	BBB40TE1KTT	135.1	BBB40TE2KTT
	250	900	350	154	BBB40TE1LTT	161	BBB40TE2LTT
	300	900	450	167	BBB40TE1MTT	177	BBB40TE2MTT
	350	900	450	170	BBB40TE1YTT	201.5	BBB40TE2YTT
	400	900	450	157.6	BBB40TE1NTT	173.2	BBB40TE2NTT
450	100	950	375	Please contact us		188	BBB45TE2FTT
	150	950	375			190	BBB45TE2JTT
	200	950	375			193	BBB45TE2KTT
	250	950	375			197	BBB45TE2LTT
	300	950	475			213	BBB45TE2MTT
	350	950	475			221	BBB45TE2YTT
	400	950	475			229	BBB45TE2NTT
	450	950	475			237	BBB45TE2PTT
500	100	1000	400	213	BBB50TE1FTT	241	BBB50TE2FTT
	150	1000	400	213	BBB50TE1JTT	241	BBB50TE2JTT
	200	1000	400	218	BBB50TE1KTT	246	BBB50TE2KTT
	250	1000	400	222	BBB50TE1LTT	274	BBB50TE2LTT
	300	1000	500	235	BBB50TE1MTT	290	BBB50TE2MTT
	400	1000	500	244	BBB50TE1NTT	316	BBB50TE2NTT
	450	1000	500	Please contact us		290	BBB50TE2PTT
	500	1000	500	256	BBB50TE1QTT	304	BBB50TE2QTT
600	100	1100	450	304	BBB60TE1FTT	350	BBB60TE2FTT
	150	1100	450	307	BBB60TE1JTT	398	BBB60TE2JTT
	200	1100	450	309	BBB60TE1KTT	408	BBB60TE2KTT
	250	1100	450	313	BBB60TE1LTT	358	BBB60TE2LTT
	300	1100	550	326	BBB60TE1MTT	369	BBB60TE2MTT
	400	1100	550	334	BBB60TE1NTT	436	BBB60TE2NTT
	450	1100	550	Please contact us		404	BBB60TE2PTT
	500	1000	550	345	BBB60TE1QTT	380	BBB60TE2QTT
600	1100	550	361	BBB60TE1RTT	519	BBB60TE2RTT	

* PN 25 and PN 40 please contact us.

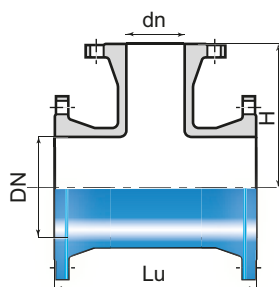

All fixed flanged tee (blue epoxy coating in compliance with EN 14901)

Available on request.

DN	dn	dimensions		PN 10		PN 16	
		Lu (mm)	Hu (mm)	weight (kg)	reference	weight (kg)	reference
700	700	1200	600	510	BBB70TE1STT	510	BBB70TE2STT
800	800	1350	675	700	BBB80TE1TTT	734	BBB80TE2TTT
900	900	1500	750	907	BBB90TE1UTT	940	BBB90TE2UTT
1000	1000	1650	830	1194	BBC10TE1VTT	1260	BBC10TE2VTT
1100	700	1578	900	-	-	-	-
1100	800	1578	915	-	BBC11TE1TTT	-	-
1100	900	1578	930	-	-	-	-
1100	1000	1578	920	-	-	-	-
1100	1100	1578	907	-	-	-	-
1200	600	1250	885	-	-	1295	BBC12TE2RTT
1200	700	1665	900	1586	BBC12TE1STT	1711	BBC12TE2STT
1200	800	1665	915	1602	BBC12TE1TTT	1762	BBC12TE2TTT
1200	900	1665	930	1674	BBC12TE1UTT	1636	BBC12TE2UTT
1200	1000	1665	920	1577	BBC12TE1VTT	1686	BBC12TE2VTT
1200	1100	1900	907	-	-	-	-
1200	1200	1900	950	1810	BBC12TE1BTT	1979	BBC12TE2BTT
1400	800	2470	1010	-	-	-	-
1400	900	2470	1010	-	-	-	-
1400	1000	2470	1040	-	-	2612	BBC14TE2VTT
1400	1200	2470	1070	-	-	-	-
1400	1400	2470	1100	-	-	2833	BBC14TE2CTT

* PN 25 and PN 40 please contact us.

All fixed flanged level invert tee (blue epoxy coating in compliance with EN 14901)

Available on request.

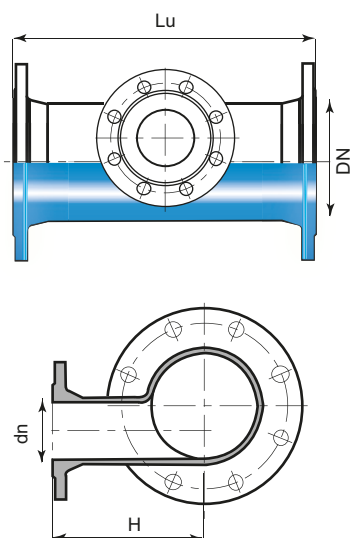

DN	dn	dimensions		weight (kg)	PN 16
		Lu (mm)	Hu (mm)		reference
100	80	360	195	19.5	BBB10TT1ETT
150	80	440	220	29.5	BBB15TT1ETT
200	80	520	250	42.5	BBB20TT2ETT
	100	520	250	43.5	BBB20TT2FTT
250	80	700	275	66	BBB25TT2ETT
	100	700	275	68.5	BBB25TT2FTT
	150	700	275	70	BBB25TT2JTT
300	80	800	305	92	BBB30TT2ETT
	100	800	305	95.5	BBB30TT2FTT
	150	800	305	99	BBB30TT2JTT
350	150	850	340	128	BBB35TT2JTT
	80	900	365	153	BBB40TT2ETT
400	100	900	365	156	BBB40TT2FTT
	150	900	365	162	BBB40TT2JTT
	200	900	365	167	BBB40TT2KTT
450	100	950	380	189	BBB45TT2FTT
	150	950	380	197	BBB45TT2JTT
500	100	1000	400	241	BBB50TT2FTT
	150	1000	400	248	BBB50TT2JTT
600	100	1100	435	171	BBB60TT2FTT
	150	1100	450	360	BBB60TT2JTT
	200	1100	450	396	BBB60TT2KTT
700	200	870	500	239	BBB70UT2KTT
	200	910	540	489	BBB80UT2KTT
800	300	910	580		Contact us
	200	950	580	483	BBB90UT2KTT
900	300	950	580		Contact us
	200	990	630	627	BBC10UT2KTT

* PN 10, PN 25 and PN 40 please contact us.

All fixed flanged radial tee (blue epoxy coating in compliance with EN 14901)

Available on request.

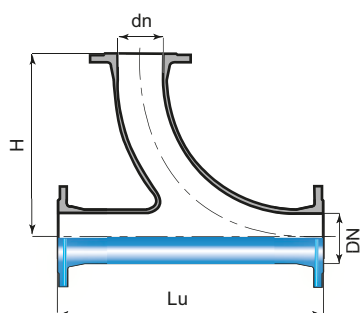

DN	dn	dimensions		weight (kg)	PN 16
		Lu (mm)	Hu (mm)		reference
80	80	545	380	23	BBA80TW1ETT
100	100	580	400	29.5	BBB10TW1FTT
150	150	670	450	48.5	BBB15TW1JTT
200	200	760	500	72.5	BBB20TW2KTT
250	250	900	550	106	BBB25TW2LTT
300	300	1000	600	146	BBB30TW2MTT
350	350	1100	650	204	BBB35TW2YTT
400	400	1200	700	278	BBB40TW2NTT
450	450	1300	750	368	BBB45TW2PTT
500	500	1400	800	526	BBB50TW2QTT
600	600	1600	900		Please contact us

* PN 10, PN 25 and PN 40 please contact us.

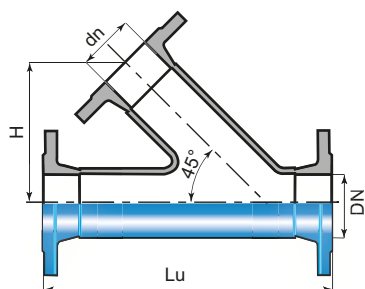

All fixed flanged 45° tee (blue epoxy coating in compliance with EN 14901)

Available on request.

DN	dn	dimensions		PN 10		PN 16	
		Lu (mm)	Hu (mm)	weight (kg)	reference	weight (kg)	reference
80	80	400	195	21	BBA80TU1ETT	21	BBA80TU1ETT
100	80	430	215	Please contact us			
	100	430	215	27	BBB10TU1FTT	27	BBB10TU1FTT
150	100	530	270	Please contact us			
	150	530	270	47	BBB15TU1JTT	47	BBB15TU1JTT
200	100	600	321	BBB20TU1FTT			
	150	600	321	Please contact us			
	200	600	321	71.4	BBB20TU1KTT	71	BBB20TU2KTT
250	150	700	363	Please contact us			
	200	700	363	Please contact us			
	250	700	363	106.2	BBB25TU1LTT	105	BBB25TU2LTT
300	200	800	412	Please contact us			
	250	800	412	Please contact us			
	300	800	412			149.2	BBB30TU2MTT
400	300	960	472	Please contact us			
	400	960	512			215	BBB40TU2NTT

PN 25 and PN 40 please contact us.

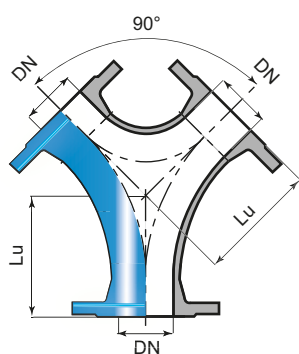

All fixed flanged Y (blue epoxy coating in compliance with EN 14901)

Available on request.

DN	dimensions Lu (mm)	PN 10		PN 16	
		weight (kg)	reference	weight (kg)	reference
80	165	15.6	BBA80YN10TT	15.6	BBA80YN10TT
100	180	19.3	BBB10YN10TT	19.3	BBB10YN10TT
150	220	32.5	BBB15YN10TT	32.5	BBB15YN10TT
200	260	48.4	BBB20YN10TT	49	BBB20YN20TT
250	350	Please contact us		81	BBB25YN20TT
300	400	Please contact us		115	BBB30YN20TT
400	500	Please contact us		220	BBB40YN20TT
450	550	Please contact us		280	BBB45YN20TT

* PN 25 and PN 40 please contact us.

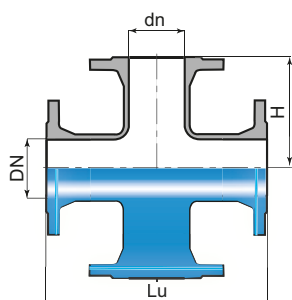

All fixed flanged cross (blue epoxy coating in compliance with EN 14901)

Available on request.

DN	dn	dimensions		PN 10		PN 16	
		Lu (mm)	Hu (mm)	weight (kg)	reference	weight (kg)	reference
80	80	330	165	22	BBA80XN1ETT	22	BBA80XN1ETT
100	100	360	180	25	BBB10XN1FTT	25	BBB10XN1FTT
150	100	440	210	38	BBB15XN1FTT	38	BBB15XN1FTT
	150	440	220	45	BBB15XN1JTT	45	BBB15XN1JTT
200	100	520	240	54	BBB20XN1FTT	48	BBB20XN2FTT
	150	520	250	57	BBB20XN1JTT	61	BBB20XN2JTT
	200	520	260	66	BBB20XN1KTT	67	BBB20XN2KTT
250	250	700	350	104	BBB25XN1LTT	110.5	BBB25XN2LTT
300	300	800	400	145	BBB30XN1MTT	148	BBB30XN2MTT
400	400	900	450	214	BBB40XN1NTT	234	BBB40XN2NTT
500	500	1000	500	305	BBB50XN1QTT	361	BBB50XN2QTT
600	600	1100	550	424	BBB60XN1RTT	523	BBB60XN2RTT

* PN 25 and PN 40 please contact us.

All fixed flanged concentric taper (blue epoxy coating in compliance with EN 14901)

Available on request.

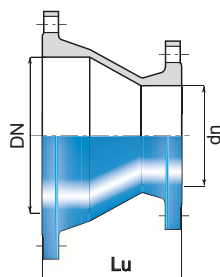

DN	dn	dimensions Lu (mm)	PN 10		PN 16	
			weight (kg)	reference	weight (kg)	reference
80	40		6.6	BBA80VE1ATT	6.6	BBA80VE1ATT
	50	200	8.7	BBA80VE1BTT	8.7	BBA80VE1BTT
	65		7.9	BBA80VE1DTT	7.9	BBA80VE1DTT
100	40		11.5	BBB10VE1ATT	11.5	BBB10VE1ATT
	50	200	8.6	BBB10VE1BTT	8.6	BBB10VE1BTT
	65	205	8.7	BBB10VE1DTT	8.7	BBB10VE1DTT
	80	200	9.3	BBB10VE1ETT	9.3	BBB10VE1ETT
125	80	200	10.5	BBB12VE1ETT	10.5	BBB12VE1ETT
	100	200	11.4	BBB12VE1FTT	11.4	BBB12VE1FTT
150	80	200	12	BBB15VE1ETT	10	BBB15VE1ETT
	100	200	12.8	BBB15VE1FTT	12.8	BBB15VE1FTT
	125	200	14	BBB15VE1GTT	14	BBB15VE1GTT
200	80	300	18	BBB20VE1ETT	18	BBB20VE2ETT
	100	300	36.2	BBB20VE1FTT	36.2	BBB20VE2FTT
	125		20.5	BBB20VE1GTT	20.5	BBB20VE2GTT
	150	300	21.8	BBB20VE1JTT	21.8	BBB20VE2JTT
250	80	600	23	BBB25VE1ETT	23	BBB25VE2ETT
	100	300	40	BBB25VE1FTT	40	BBB25VE2FTT
	150	300	40	BBB25VE1JTT	52	BBB25VE2JTT
	200	300	47	BBB25VE1KTT	47	BBB25VE2KTT
300	80	700	-	-	43	BBB30VE2ETT
	100	300	29.5	BBB30VE1FTT	34.5	BBB30VE2FTT
	150	300	60.7	BBB30VE1JTT	60.7	BBB30VE2JTT
	200	300	37.5	BBB30VE1KTT	58	BBB30VE2KTT
	250	300	72	BBB30VE1LTT	72	BBB30VE2LTT
350	200	600	50	BBB35VE1KTT	50	BBB35VE2KTT
	250	300	58	BBB35VE1LTT	58	BBB35VE2LTT
	300	300	64.4	BBB35VE1MTT	52.5	BBB35VE2MTT
400	200	300	48.5	BBB40VE1KTT	60	BBB40VE2KTT
	250	300	84	BBB40VE1LTT	69.5	BBB40VE2LTT
	300	300	113.5	BBB40VE1MTT	113.5	BBB40VE2MTT
	350	300	59	BBB40VE1YTT	67	BBB40VE2YTT
450	250	600			87.5	BBB45VE2LTT
	300	600			95	BBB45VE2MTT
	350	600	Please contact us		104	BBB45VE2YTT
	400	300			81	BBB45VE2NTT
500	250	700			114	BBB50VE2LTT
	300	600	111	BBB50VE1MTT	112.5	BBB50VE2MTT
	350	600	138.5	BBB50VE1YTT	132.9	BBB50VE2YTT
	400	600	127	BBB50VE1NTT	152	BBB50VE2NTT
	450	600			189	BBB50VE2PTT
600	300	800			171	BBB60VE2MTT
	350	700			167	BBB60VE2YTT
	400	600	135	BBB60VE1NTT	164	BBB60VE2NTT
	450	600	223	BBB60VE1PTT	230	BBB60VE2PTT
	500	600	149	BBB60VE1QTT	190	BBB60VE2QTT
700	400	600	220	BBB70VE1NTT	181	BBB70VE2NTT
	450	700			285	BBB70VE2PTT
	500	600	281	BBB70VE1QTT	266	BBB70VE2QTT
	600	600	218	BBB70VE1RTT	243	BBB70VE2RTT
800	500	800	500	BBB80VE1QTT	480.5	BBB80VE2QTT
	600	600	345	BBB80VE1RTT	354	BBB80VE2RTT
	700	600	272	BBB80VE1STT	269	BBB80VE2STT
900	700	600	440	BBB90VE1STT	414	BBB90VE2STT
	800	600	337	BBB90VE1TTT	359	BBB90VE2TTT
1000	800	600	570	BBC10VE1TTT	520	BBC10VE2TTT
	900	600	415	BBC10VE1UTT	447	BBC10VE2UTT
1100	600		Please contact us			
1200	600	1490	870	BBC12VE1RTT	975	BBC12VE2RTT
	1000	860	689	BBC12VE1VTT	717	BBC12VE2VTT
1400	1200	760	846	BBC14VE1BTT	955	BBC14VE2BTT
1500	1200	760		Please contact us		
	1400	570		Please contact us		
1600	1200	1085	1194	BBC16VE1BTT		Please contact us
	1400	890	1259	BBC16VE1CTT	1309	BBC16VE2CTT
	1500	890	1169	BBC16VE1DTT	1344	BBC16VE2DTT

DN	dn	dimensions Lu (mm)	PN 10		PN 16	
			weight (kg)	reference	weight (kg)	reference
1800	1200	1445	1626	BBC18VE1ETT	Please contact us	
	1400	1250				
	1500	1250				
	1600	970				
2000	1200	1825	2049	BBC20VE1FTT	Please contact us	
	1400	1630				
	1500	1630				
	1600	1350				
	1800	1030				

* PN 25 and PN 40 please contact us.

All fixed flanged flat taper (blue epoxy coating in compliance with EN 14901)

Available on request.

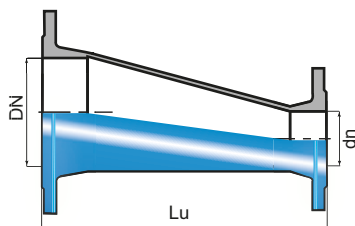

DN	dn	dimensions Lu (mm)	PN 16	
			weight (kg)	reference
80	50	200	7.3	BBA80VT1BTT
100	50	300	9.4	BBB10VT1BTT
	80	200	9.0	BBB10VT1ETT
150	80	400	16.1	BBB15VT1ETT
	100	300	15	BBB15VT1FTT
200	80	600	25.5	BBB20VT2ETT
	100	600	27	BBB20VT2FTT
	150	300	22	BBB20VT2JTT
250	100	600	34	BBB25VT2FTT
	150	600	38	BBB25VT2JTT
	200	300	29.5	BBB25VT2KTT
300	150	600	46	BBB30VT2JTT
	200	600	51	BBB30VT2KTT
	250	300	39.5	BBB30VT2LTT
350	200	600	60.5	BBB35VT2KTT
	250	600	67	BBB35VT2LTT
	300	300	52	BBB35VT2MTT
400	200	600	71	BBB40VT2KTT
	250	600	77	BBB40VT2LTT
	300	600	84	BBB40VT2MTT
	350	300	67	BBB40VT2YTT
600	500	600	190	BBB60VT2QTT

* PN 25 and PN 40 please contact us.

All fixed flanged Bellmouth (blue epoxy coating in compliance with EN 14901)

Available on request.

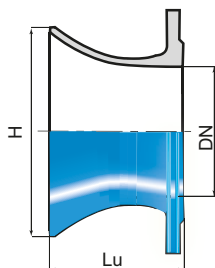

DN	dimensions		PN 10		PN 16	
	Lu (mm)	Hu (mm)	weight (kg)	reference	weight (kg)	reference
80	135	160	5.2	BBA80BP10TT	5.2	BBA80BP10TT
100	140	185	6.3	BBB10BP10TT	6.3	BBB10BP10TT
150	155	245	10	BBB15BP10TT	10	BBB15BP10TT
200	170	310	15	Please contact us	14.7	BBB20BP20TT
250	190	370	21.4		21	BBB25BP20TT
300	210	435	29	BBB30BP10TT	29	BBB30BP20TT
350	225	495	38	Please contact us	39	BBB35BP20TT
400	250	520	49		51	Contact us
450	260	620	60	Please contact us	63	BBB45BP20TT
500	300	640	83		83	Contact us
600	300	764	122		122	BBB60BP20TT
700	500	1000	154	BBB70BP10TT	259	BBB70BP20TT
800	380	1055	283	BBB80BP10TT	203	BBB80BP20TT
900	390	1160	234	Please contact us	239	BBB90BP20TT
1200	470	1523	460	BBC12BP10TT	515	Please contact us

PN 25 and PN 40 please contact us

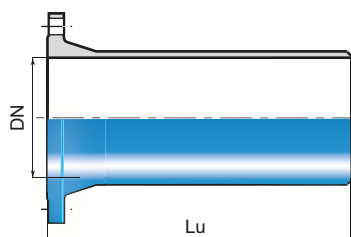

Flanged spigot (blue epoxy coating in compliance with EN 14901)

DN	dimensions Lu (mm)	PN 10		PN 16	
		weight (kg)	reference	weight (kg)	reference
80	350	8	BBA80BU10TT	8	BBA80BU10TT
100	360	9.6	BBB10BU10TT	9.6	BBB10BU10TT
125	370	12.5	BBB12BU10TT	12.5	BBB12BU10TT
150	380	17.1	BBB15BU10TT	17.1	BBB15BU10TT
200	400	24.5	BBB20BU10TT	24	BBB20BU20TT
250	420	33	BBB25BU10TT	33	BBB25BU20TT
300	440	46	BBB30BU10TT	45	BBB30BU20TT
350	460	58	BBB35BU10TT	58	BBB35BU20TT
400	480	70	BBB40BU10TT	74	BBB40BU20TT
450	500	86	Contact us	92	BBB45BU20TT
500	520	104	BBB50BU10TT	117	BBB50BU20TT
600	560	144	BBB60BU10TT	169	BBB60BU20TT
700	600	189	SEB70BU10TT	187	SEB70BU20TT
800	600	239	SEB80BU10TT	250	SEB80BU20TT
900	600	287	SEB90BU10TT	298	SEB90BU20TT
1000	600	354	SEC10BU10TT	376	SEC10BU20TT
1200	600	469	SEC12BU10TT	526	SEC12BU20TT
1400	710		SSC14BU10TT		SSC14BU20TT
1500	750				SSC15BU20TT
1600	780		SSC16BU10TT	1019	SSC16BU20TT
1800	845			1359	SSC18BU20TT
2000	885	1643	SSC20BU10TT	1749	SSC20BU20TT

PN 25 and PN 40 please contact us.

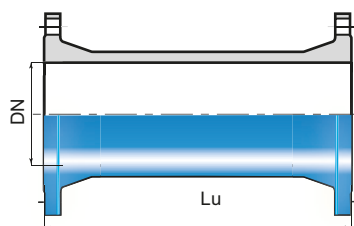

Short double flanged pipe (blue epoxy coating in compliance with EN 14901)

DN	dimensions Lu (mm)	PN 10		PN 16		
		weight (kg)	reference	weight (kg)	reference	
50	250	6.5	BBA50MT1ATT	6.5	BBA50MT1ATT	
	100	7.2	BBA80MT1UTT	7.2	BBA80MT1UTT	
	150	7.8	BBA80MT1ZTT	7.8	BBA80MT1ZTT	
	200	8.8	BBA80MT1VTT	8.8	BBA80MT1VTT	
80	250	9.6	BBA80MT1ATT	9.6	BBA80MT1ATT	
	300	10.4	BBA80MT1WTT	10.4	BBA80MT1WTT	
	400	12	BBA80MT1XTT	12	BBA80MT1XTT	
	600	13.7	BBA80MT1QTT	13.7	BBA80MT1QTT	
	100	100	8.3	BBB10MT1UTT	8.3	BBB10MT1UTT
		200	10.1	BBB10MT1VTT	10.1	BBB10MT1VTT
250		11	BBB10MT1ATT	11	BBB10MT1ATT	
300		12.7	BBB10MT1WTT	12.7	BBB10MT1WTT	
400		15	BBB10MT1XTT	15	BBB10MT1XTT	
150	500	15.1	BBB10MT1BTT	15.1	BBB10MT1BTT	
	200	16.5	BBB15MT1VTT	16.5	BBB15MT1VTT	
	250	16.7	BBB15MT1ATT	16.7	BBB15MT1ATT	
	300	19.7	BBB15MT1WTT	19.7	BBB15MT1WTT	
200	400	23.5	BBB15MT1XTT	23.5	BBB15MT1XTT	
	200	Please contact us		21.1	BBB20MT2VTT	
	250		23.1	BBB20MT2ATT		
	300		25	BBB20MT2WTT		
400	31.5		BBB20MT2XTT			
250	250		31.5	BBB25MT2ATT		
	300		34.2	BBB25MT2WTT		
	500		43.8	BBB25MT2BTT		
300	200		45	BBB30MT2VTT		
	250		41.4	BBB30MT2ATT		
	300		44.8	BBB30MT2WTT		
	500		58	BBB30MT2BTT		
400	700		134	BBB40MT2RTT		
450	250	82.8	BBB45MT2ATT			
500	250	86				
	500	162.6				
	600	182				
600	250	Please contact us		169.9	BBB60MT2ATT	
	500	219.5	BBB60MT1BTT	235.7	BBB60MT2BTT	

PN 25 and PN 40 please contact us. For other diameters, please consult us.

Anchoring flanged spigot (integrally casted fixed flanges)

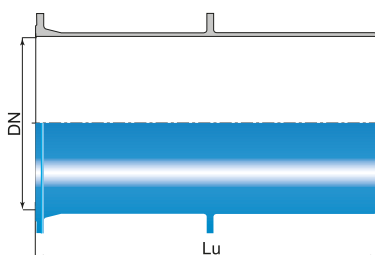

DN	dimensions Lu (mm)	PN 10		PN 16	
		weight (kg)	reference	weight (kg)	reference
80					
100					
125		Please contact us			
150					
200					
250	1000	93	BBB25ME1CTT	93.2	BBB25ME2CTT
300	1000	120	Contact us	119.8	BBB30ME2CTT
350	1000	150	BBB35ME1CTT	146	BBB35ME2CTT
400	1000			175	BBB40ME2CTT
450	1000	220	BBB45ME1CTT	214	BBB45ME2CTT
500	1000	254	BBB50ME1CTT	256	BBB50ME2CTT
600	1000	341	BBB60ME1CTT	349	BBB60ME2CTT
600	2000	474	BBB60ME1ETT		
700					
800		Please contact us			
900					
1000	1500				
1100					
1200	2000	1766	BBC12ME1ETT	1799	BBC12ME2ETT
1400					
1500		Please contact us			
1600					
1800					
2000	3000	6145	BBC20ME1GTT		

PN 25 and PN 40 please contact us.

Double welded flanged pipe:
 - internal: cement mortar lining
 - external: BioZinalium.

Double welded flanged pipe



DN	thickness (mm)	barrel weight (with cement mortar) in kg/m	weight			
			flange PN 10 (kg)	flange PN 16 (kg)	flange PN 25 (kg)	flange PN 40 (kg)
60	6.0	11.2	2.6	2.6	2.9	2.8
80	6.0	14.7	3.2	3.2	3.2	2.9
100	6.1	17.9	3.7	3.7	4.2	3.8
125	6.2	22.1	4.8	4.8	5.0	5.9
150	6.3	26.3	6.0	6.0	6.8	8.0
200	6.4	36.2	9.7	8.5	10.2	14.0
250	6.8	47.8	13.5	12.2	15.5	—
300	7.2	59.9	14.2	16.0	24.2	—
350	7.7	76.4	20.5	24.5	32.5	—
400	8.1	90.6	25.0	30.5	42.5	—
450	8.6	106.7	29.5	39.0	56.5	—
500	9.0	123.1	34.5	49.0	63.0	—
600	9.9	159.7	49.0	75.5	88.5	—
700	10.8	205.4	67.0	82.0	—	—
800	11.7	251.3	90.0	107.0	—	—
900	12.6	300.7	107.5	126.0	—	—
1000	13.5	354.3	134.5	170.0	—	—

On request we can supply pipes equipped with only one welded flange.

DN	PN 10			
	1000 mm reference	2000 mm reference	3000 mm reference	4000 mm reference
60	BBA60FA1CAQ	BBA60FA1EAQ	BBA60FA1GAQ	BBA60FA1JAQ
80	BBA80FA1CAQ	BBA80FA1EAQ	BBA80FA1GAQ	BBA80FA1JAQ
100	BBB10FA1CAQ	BBB10FA1EAQ	BBB10FA1GAQ	BBB10FA1JAQ
125	BBB12FA1CAQ	BBB12FA1EAQ	BBB12FA1GAQ	BBB12FA1JAQ
150	BBB15FA1CAQ	BBB15FA1EAQ	BBB15FA1GAQ	BBB15FA1JAQ
200	BBB20FA1CAQ	BBB20FA1EAQ	BBB20FA1GAQ	BBB20FA1JAQ
250	BBB25FA1CAQ	BBB25FA1EAQ	BBB25FA1GAQ	BBB25FA1JAQ
300	BBB30FA1CAQ	BBB30FA1EAQ	BBB30FA1GAQ	BBB30FA1JAQ
350	BBB35FA1CAQ	BBB35FA1EAQ	BBB35FA1GAQ	BBB35FA1JAQ
400	BBB40FA1CAQ	BBB40FA1EAQ	BBB40FA1GAQ	BBB40FA1JAQ
450	BBB45FA1CAQ	BBB45FA1EAQ	BBB45FA1GAQ	BBB45FA1JAQ
500	BBB50FA1CAQ	BBB50FA1EAQ	BBB50FA1GAQ	BBB50FA1JAQ
600	BBB60FA1CAQ	BBB60FA1EAQ	BBB60FA1GAQ	BBB60FA1JAQ
700	BBB70FA1CAQ	BBB70FA1EAQ	BBB70FA1GAQ	BBB70FA1JAQ
800	BBB80FA1CAQ	BBB80FA1EAQ	BBB80FA1GAQ	BBB80FA1JAQ
900	BBB90FA1CAQ	BBB90FA1EAQ	BBB90FA1GAQ	BBB90FA1JAQ
1000	BBC10FA1CAQ	BBC10FA1EAQ	BBC10FA1GAQ	BBC10FA1JAQ

DN	PN 10			
	5000 mm reference	5900 mm reference	6000 mm reference	6400 mm reference
60	BBA60FA1LAQ	BBA60FA1NAQ		
80	BBA80FA1LAQ	BBA80FA1NAQ		
100	BBB10FA1LAQ	BBB10FA1NAQ		
125	BBB12FA1LAQ	BBB12FA1NAQ		
150	BBB15FA1LAQ	BBB15FA1NAQ		
200	BBB20FA1LAQ	BBB20FA1NAQ		
250	BBB25FA1LAQ	BBB25FA1NAQ		
300	BBB30FA1LAQ	BBB30FA1NAQ		
350	BBB35FA1LAQ	BBB35FA1NAQ		
400	BBB40FA1LAQ	BBB40FA1NAQ		
450	BBB45FA1LAQ	BBB45FA1NAQ		
500	BBB50FA1LAQ	BBB50FA1NAQ		
600	BBB60FA1LAQ	BBB60FA1NAQ		
700	BBB70FA1LAQ		BBB70FA1NAQ	BBB70FA1TAQ
800	BBB80FA1LAQ		BBB80FA1NAQ	BBB80FA1TAQ
900	BBB90FA1LAQ		BBB90FA1NAQ	BBB90FA1TAQ
1000	BBC10FA1LAQ		BBC10FA1NAQ	BBC10FA1TAQ

PN 16 and PN 25, please contact us.

Double welded flanged with blue BIOZINALIUM anchoring pipe with puddle flange PN 10

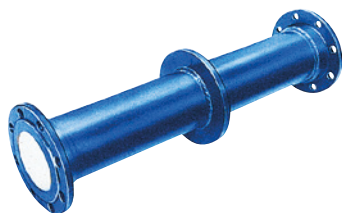

DN	weight* (kg)	reference
60	13.8	BBA60FD1BAQ
80	17.5	BBA80FD1BAQ
100	21.0	BBB10FD1BAQ
125	27.0	BBB12FD1BAQ
150	33.0	BBB15FD1BAQ
200	44.5	BBB20FD1BAQ
250	79.0	BBB25FD1BAQ
300	104.0	BBB30FD1BAQ
350	130.0	BBB35FD1BAQ
400	156.0	BBB40FD1BAQ
450	183.0	BBB45FD1BAQ
500	213.0	BBB50FD1CAQ
600	286.0	BBB60FD1CAQ
700	480.0	BBB70FD1CAQ
800	610.0	BBB80FD1CAQ
900	729.0	BBB90FD1CAQ
1000	880.0	BBC10FD1CAQ

Length:

DN 60 to 200 Lg = 0.6 m.

DN 250 to 600 Lg = 1 m.

DN 700 to 1000 Lg = 1.5 m.

*Class K9

Flange spigot blue BIOZINALIUM anchoring pipe with puddle flange PN 10



DN	weight* (kg)	reference
60	12.3	BBA60FE1BAQ
80	15.7	BBA80FE1BAQ
100	18.9	BBB10FE1BAQ
125	24.0	BBB12FE1BAQ
150	30.0	BBB15FE1BAQ
200	39.5	BBB20FE1BAQ
250	67.0	BBB25FE1BAQ
300	86.0	BBB30FE1BAQ
350	109.0	BBB35FE1BAQ
400	131.0	BBB40FE1BAQ
450	153.0	BBB45FE1BAQ
500	178.0	BBB50FE1CAQ
600	237.0	BBB60FE1CAQ
700	413.0	BBB70FE1CAQ
800	519.0	BBB80FE1CAQ
900	621.0	BBB90FE1CAQ
1000	745.0	BBC10FE1CAQ

Length:

DN 60 to 200 Lg = 0.7 m.

DN 250 to 600 Lg = 1 m.

DN 700 to 1000 Lg = 1.5 m.

*Class K9

shape 1

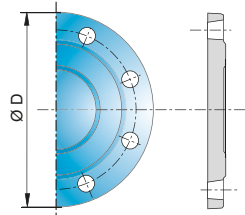

shape 2

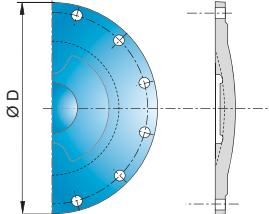

shape 3

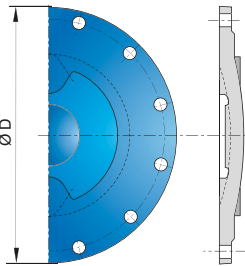

Blank flange (blue epoxy coating in compliance with EN 14901)

DN	PN 10		Ø D (mm)	PN 16		Ø D (mm)	shape
	weight (kg)	reference		weight (kg)	reference		
40	2.0	BBA40QN10TT	150	2.0	BBA40QN10TT	150	1
50	3.0	BBA50QN10TT	165	3.0	BBA50QN10TT	165	
60	2.7	BBA60QN10TT	175	2.7	BBA60QN10TT	175	
65	3.1	BBA65QN10TT	185	3.1	BBA65QN10TT	185	
80	3.5	BBA80QN10TT	200	3.5	BBA80QN10TT	200	
100	4.3	BBB10QN10TT	220	4.3	BBB10QN10TT	220	
125	5.6	BBB12QN10TT	250	5.6	BBB12QN10TT	250	
150	7.2	BBB15QN10TT	285	7.2	BBB15QN10TT	285	
200	11	BBB20QN10TT	340	11	BBB20QN20TT	340	
250	16.9	BBB25QN10TT	400	16.9	BBB25QN20TT	400	
300	26.5	BBB30QN10TT	455	26.5	BBB30QN20TT	455	2
350	32.5	BBB35QN10TT	505	37.5	BBB35QN20TT	520	
400	45.5	BBB40QN10TT	565	43.5	BBB40QN20TT	580	
450	55	BBB45QN10TT	615	64	BBB45QN20TT	640	
500	70	BBB50QN10TT	670	84	BBB50QN20TT	715	
600	106	BBB60QN10TT	780	133	BBB60QN20TT	840	
700	153	BBB70QN10TT	895	166	BBB70QN20TT	910	
800	214	BBB80QN10TT	1015	230	BBB80QN20TT	1025	
900	279	BBB90QN10TT	1115	300	BBB90QN20TT	1125	
1000	367	BBC10QN10TT	1230	400	BBC10QN20TT	1255	
1100	405	-	1340	520	BBC11QN20TT	1355	3
1200	506	BBC12QN10TT	1455	662	BBC12QN20TT	1485	
1400				993	BBC14QN20TT		
1500				1222	BBC15QN20TT		
1600				1462	BBC16QN20TT		
1800	1717	BBC18QN10TT		2016	BBC18QN20TT		
2000	2272	BBC20QN10TT		2660	BBC20QN20TT		

* PN 25 and PN 40 please contact us.

shape 1

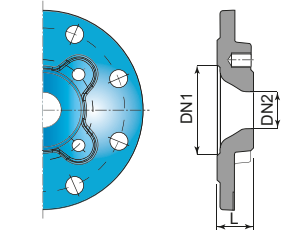

shape 2

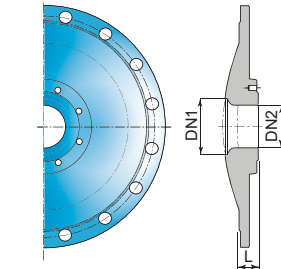

shape 3

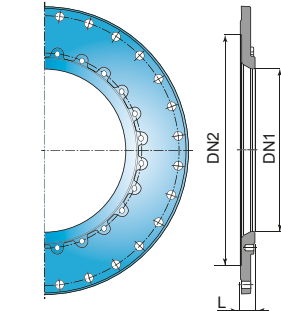

Reducing plate (blue epoxy coating in compliance with EN 14901)

DN	dn	PN 10				PN 16			
		weight (kg)	reference	shape	L (mm)	weight (kg)	reference	shape	L (mm)
100	40	4.5	BBB10RN1ANNG	1	40	4.5	Please contact us	1	40
200	80	10.9	Contact us	1	40	10.9	Please contact us	3	40
200	100	10.9	BBB20RN1FTTG	1	40	10.9	BBB20RN2FNNG	3	40
200	125	10.8	Contact us	1	40	10.6		3	40
250	100	17.9	BBB25RN1FNNG	1	42	17.9		3	42
300	100	24.9		2	44.5	24.9		2	44.5
300	150	27.2		2	44.5	25.7		2	46.5
300	200	27.7		1	46.5	29.1		2	46.5
350	250	37.8		2	49.5	43.4	Please contact us	2	46.5
400	100	44.9	Please contact us	2	27.5	47.9		2	44.5
400	150	46.7		2	29.5	51.7		2	29.5
400	200	47.7		2	46.5	50.6		2	47.5
400	250	55.8		2	46.5	51.9		2	50
400	300	43.8		2	53	48.4		2	51.5
600	100	105.9	BBB60RN1FTTG	2	4	131.9	BBB60RN2FTTG	2	4
600	150	106.7	Contact us	2	12.5	133.7	BBB60RN2JTTG	2	10
600	200	108.7	BBB60RN1KTTG	2	20	130.6	BBB60RN2KNNG	2	20
600	450	67.9		2	63	104.0	BBB60RN2PNNG	2	66
700	500	108.9		1	56	140.2		3	67
1000	700	254.2	Please contact us	1	63	263.4	Please contact us	1	63
1000	800	232.3		1	98	244.2		1	68

PN 25 and PN 40 please contact us.



Reducing flange PN 10/16/25

DN	dn	pinning	PN	weight (kg)	reference
60	40	DOUBLE	10/16	5.7	BBA60RM1ATT
60	40	DOUBLE	25	5.7	BBA60RM3ATT
60	50	DOUBLE	10/16	5.6	BBA60RM1BTT
60	50	DOUBLE	25	5.6	BBA60RM3BTT
60	65	DOUBLE	10/16	5.4	BBA60RM1DTT
80	40	DOUBLE	10/16	5.1	BBA80RM1ATT
80	40	DOUBLE	25	5.1	BBA80RM3ATT
80	50	DOUBLE	10/16	5.6	BBA80RM1BTT
80	50	DOUBLE	25	5.6	BBA80RM3BTT
80	60	DOUBLE	10/16	5.4	BBA80RM1CTT
80	60	DOUBLE	25	5.4	BBA80RM3CTT
100	40	DOUBLE	10/16	6.6	BBB10RM1ATT
100	50	DOUBLE	10/16	6.3	BBB10RM1BTT
100	60	DOUBLE	10/16	6.5	BBB10RM1CTT
100	80	DOUBLE	10/16	6.9	BBB10RM1ETT
125	60	DOUBLE	10/16	8.2	BBB12RM1CTT
125	80	DOUBLE	10/16	8	BBB12RM1ETT
125	100	DOUBLE	10/16	7.6	BBB12RM1FTT
150	60	SIMPLE	10/16	11.8	BBB15RM1CTT
150	80	SIMPLE	10/16	10.7	BBB15RM1ETT
150	100	DOUBLE	10/16	11.2	BBB15RM1FTT
200	60	SIMPLE	10	14.8	BBB20RM1CTT
200	60	SIMPLE	16	14.7	BBB20RM2CTT
200	80	SIMPLE	10	14.7	BBB20RM1ETT
200	80	SIMPLE	16	14.5	BBB20RM2ETT
200	100	SIMPLE	10	15	BBB20RM1FTT
200	100	SIMPLE	16	15	BBB20RM2FTT
200	125	SIMPLE	10	13.7	BBB20RM1GTT
200	125	SIMPLE	16	13.6	BBB20RM2GTT
200	150	DOUBLE	10	16.5	BBB20RM1JTT
200	150	DOUBLE	16	16.6	BBB20RM2JTT
250	80	SIMPLE	10	22.1	BBB25RM1ETT
250	80	SIMPLE	16	22.3	BBB25RM2ETT
250	100	SIMPLE	10	22	BBB25RM1FTT
250	100	SIMPLE	16	21.9	BBB25RM2FTT
250	150	SIMPLE	10	21.5	BBB25RM1JTT
250	150	SIMPLE	16	20.4	BBB25RM2JTT
250	200	DOUBLE	10	21.3	BBB25RM1KTT
250	200	DOUBLE	16	21.6	BBB25RM2KTT
300	100	SIMPLE	10	27	BBB30RM1FTT
300	100	SIMPLE	16	30	BBB30RM2FTT
300	150	SIMPLE	10	33	BBB30RM1JTT
300	150	SIMPLE	16	36	BBB30RM2JTT
300	200	SIMPLE	10	25	BBB30RM1KTT
300	200	SIMPLE	16	25	BBB30RM2KTT
300	250	DOUBLE	10	28	BBB30RM1LTT
300	250	DOUBLE	16	43	BBB30RM2LTT

* PN 40 please contact us.

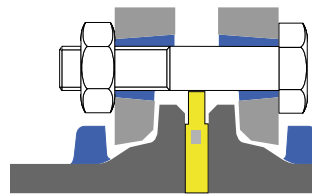

Rotatable flange
on fittings DN ≤ 600

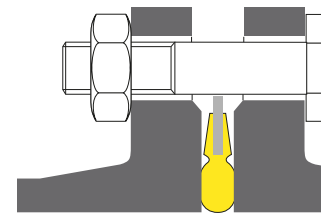

Fixed flange on pipes from DN 60 to 2000 and on fittings DN ≤ 600

For DN from DN 1100 to 2000,
please, consult us.

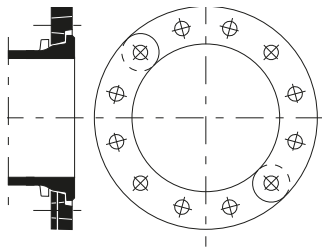

The rotatable flanges from DN 40 to DN 350 are made of 2 half-flanges and 4 quarter-flanges starting from DN 400.

Rotatable flange

DN	Weight (kg)	Reference PN10	Weight (kg)	Reference PN16	Weight (kg)	Reference PN25
40	0.700	BAA40BO10NN2	0.700	BAA40BO10NN2	0.700	BAA40BO10NN2
50	0.800	BAA50BO10NN2	0.800	BAA50BO10NN2	0.800	BAA50BO10NN2
60	0.690	BAA60BO10NN2	0.690	BAA60BO10NN2	0.890	BAA60BO30NN2
65	1.100	BAA65BO10NN2	1.100	BAA65BO10NN2	1.200	BAA65BO30NN2
80	0.890	BAA80BO10NN2	0.890	BAA80BO10NN2	0.890	BAA80BO10NN2
100	0.900	BAB10BO10NN2	0.900	BAB10BO10NN2	1.500	BAB10BO30NN2
125	1.220	BAB12BO10NN2	1.220	BAB12BO10NN2	2.100	BAB12BO30NN2
150	1.580	BAB15BO10NN2	1.580	BAB15BO10NN2	2.600	BAB15BO30NN2
200	2.950	BAB20BO10NN2	3.050	BAB20BO20NN2	3.690	BAB20BO30NN2
250	4.200	BAB25BO10NN2	4.200	BAB25BO20NN2	3.450	BAB25BO30NN2
300	5.550	BAB30BO10NN2	5.300	BAB30BO20NN2	7.180	BAB30BO30NN2
350 à 600				Consult us		

Flange joint KIT for rotatable flanged pipes and fittings

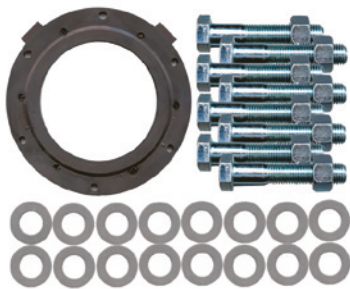

DN	PN	weight of one kit (kg)	kit reference
40	10 to 40	0.85	JBA40KV1
60	10 and 16	0.89	JBA60KV1
80	10 to 40	1.70	JBA80KV1
100	10 and 16	1.73	JBB10KV1
125	10 and 16	1.76	JBB12KV1
150	10 and 16	3.05	JBB15KV1
200	10	3.10	JBB20KV1
200	16	4.52	JBB20KV2
250	10	4.89	JBB25KV1
250	16	7.35	JBB25KV2
300	10	5.33	JBB30KV1
300	16	8.35	JBB30KV2

All the elements of a flange joint in the same packing.

Metal reinforced flange gasket



DN	Reference PN10	Reference PN16	Reference PN25
40	JBA40GV1-E12	JBA40GV1-E12	JBA40GV1-E12
50	JBA50GV1-E12	JBA50GV1-E12	JBA50GV1-E12
60	JBA60GV1-E12	JBA60GV1-E12	JBA60GV1-E12
65	JBA65GV1-E12	JBA65GV1-E12	JBA65GV1-E12
80	JBA80GV1-E12	JBA80GV1-E12	JBA80GV1-E12
100	JBB10GV1-E12	JBB10GV1-E12	JBB10GV1-E00
125	JBB12GV1-E12	JBB12GV1-E12	JBB12GV1-E00
150	JBB15GV1-E12	JBB15GV1-E12	JBB15GV1-E00
200	JBB20GV1-E12	JBB20GV1-E13	JBB20GV1-E00
250	JBB25GV1-E12	JBB25GV1-E13	JBB25GV1-E00
300	JBB30GV1-E12	JBB30GV1-E13	JBB30GV1-E00
350	JBB35GV1B-E12	JBB35GV1B-E13	JBB35GV1B-E00
400	JBB40GV1B-E12	JBB40GV1B-E13	JBB40GV1B-E00
450	JBB45GV1-E12	JBB45GV1B-E13	JBB45GV1B-E00
500	JBB50GV1B-E12	JBB50GV1B-E13	JBB50GV1B-E00
600	JBB60GV1-E12	JBB60GV1B-E13	JBB60GV1B-E00
700	JBB70GV1-E12	JBB70GV1-E13	JBB70GV1-E00
800	JBB80GV1-E12	JBB80GV1-E13	JBB80GV1-E00
900	JBB90GV1-E12	JBB90GV1-E13	JBB90GV1-E00
1000	JBC10GV1-E12	JBC10GV1-E13	JBC10GV1-E00

- Excellent mechanical properties.
- Easy installation thanks to the locating lugs.
- The joint is leak-tight with low bolting torques.



**FITTINGS FOR PLASTIC OUTER
DIAMETER**

Table of contents

■ IZIFIT® range	78	■ BLUTOP® range	83
IZIFIT bends	79	BLUTOP blends	83
IZIFIT collars	79	BLUTOP collars	84
IZIFIT tapers	80	BLUTOP tapers	84
IZIFIT tees	80	BLUTOP tees	84
IZIFIT flanges spigots	81	BLUTOP flanges spigots	85
IZIFIT flanges sockets	81	BLUTOP flanges sockets	86
IZIFIT duckfoot bend	82	BLUTOP duckfoot bend	86
IZIFIT plug	82	BLUTOP plug	86



Ductile iron fittings for PVC-U, PE and PVC-BO pressure water mains

IZIFIT® pressures according to EN 12842 and NFT 54-948

Material	PVC				PE		PVC-BO
	non anchored		anchored				
Plastic pipe	PN 10	PN 16	PN 10	PN 16	PN 10	PN 16	PN 16
63	10	16	10*	16*	10*	16*	-
75	10	16	10	16	10	16	10
90	10	16	10	16	10	16	10
110	10	16	10	16	10	16	10
125	10	16	10	16	10	16	10
140	10	16	10*	16*	10*	16*	-
160	10	16	10*	16*	10*	16*	-
200	10	16	10*	16*	10*	16*	-
225	10	16	10*	16*	10*	16*	-

* with anchoring flange

Anchored gasket IZIFIT®



DN/OD	weight (kg)	reference
75	0.109	JIL75CA
90	0.105	JIL90CA
110	0.146	JIM11CA
125	0.189	JIM12CA



90° Double socket bend IZIFIT®

DN/OD	weight (kg)	with non anchored gasket reference	with anchored gasket reference
63	3.30	KZL63CA	
75	4.40	KTL75CA	KVL75CA
90	5.50	KTL90CA	KVL90CA
110	7.10	KTM11CA	KVM11CA
125	8.80	KTM12CA	KVM12CA
140	9.50	KZM14CA	
160	11.69	KZM16CA	
200	16.42	KZM20CA	
225	19.40	KZM22CA	



45° Double socket bend IZIFIT®

DN/OD	weight (kg)	with non anchored gasket reference	with anchored gasket reference
63	3.07	KZL63CB	
75	4.20	KTL75CB	KVL75CB
90	5.10	KTL90CB	KVL90CB
110	6.20	KTM11CB	KVM11CB
125	7.00	KTM12CB	KVM12CB
140	8.65	KZM14CB	
160	10.10	KZM16CB	
200	13.26	KZM20CB	
225	16.01	KZM22CB	



22.5° Double socket bend IZIFIT®

DN/OD	weight (kg)	with non anchored gasket reference	with anchored gasket reference
63	2.57	KZL63CD	
75	3.40	KTL75CD	KVL75CD
90	4.40	KTL90CD	KVL90CD
110	5.50	KTM11CD	KVM11CD
125	6.60	KTM12CD	KVM12CD
140	6.97	KZM14CD	
160	8.44	KZM16CD	
200	11.42	KZM20CD	
225	13.67	KZM22CD	



11.3° Double socket bend IZIFIT®

DN/OD	weight (kg)	with non anchored gasket reference	with anchored gasket reference
75	3.50	KTL75CE	KVL75CE
90	3.80	KTL90CE	KVL90CE
110	5.80	KTM11CE	KVM11CE
125	6.70	KTM12CE	KVM12CE



Non sliding collar IZIFIT®

DN/OD	weight (kg)	with non anchored gasket reference	with anchored gasket reference
63	2.56	KZL63MN	
75	3.10	KZL75MN	KVL75MN
90	4.00	KTL90MN	KVL90MN
110	4.90	KTM11MN	KVM11MN
125	5.50	KTM12MN	KVM12MN
140	6.61	KZM14MN	
160	8.02	KZM16MN	
200	10.93	KZM20MN	
225	12.88	KZM22MN	



Collar IZIFIT®

DN/OD	weight (kg)	with non anchored gasket reference
75	5.30	KTL75MM
90	6.30	KTL90MM
110	7.30	KTM11MM
125	8.80	KTM12MM

Double socket taper IZIFIT®



DN/OD	Ø de mm	weight (kg)	with non anchored gasket reference	with anchored gasket reference
75	63	2.89	KZL75VE0B	
90	75	3.70	KTL90VE0C	KVL90VE0C
110	75	4.60	KTM11VE0C	KVM11VE0C
	90	5.00	KTM11VE0D	KVM11VE0D
125	75	5.00	KTM12VE0C	KVM12VE0C
	90	5.20	KTM12VE0D	KVM12VE0D
	110	5.50	KTM12VE0E	KVM12VE0E
140	90	5.51	KZM14VE0D	
	110	5.91	KZM14VE0E	
	125	6.29	KZM14VE0G	
160	75	6.02	KZM16VE0C	
	90	6.37	KZM16VE0D	
	110	6.72	KZM16VE0E	
	125	7.01	KZM16VE0G	
200	140	7.43	KZM16VE0H	
	125	8.97	KZM20VE0G	
	140	9.28	KZM20VE0H	
225	160	9.87	KZM20VE0J	
	110	9.94	KZM22VE0E	
	140	10.50	KZM22VE0H	
	160	10.96	KZM22VE0J	
	200	11.94	KZM22VE0K	

Double socket tee with fixed flanged branch IZIFIT®



DN/OD		weight (kg)	with non anchored gasket		with anchored gasket	
DN	dn		reference		reference	
63	40	5.14	KZL63TD1A			
	60 (1)	6.20	KZL63TD1C			
75	40	5.80	KTL75TD1A		KVL75TD1A	
	60	7.80	KTL75TD1C		KVL75TD1C	
	65	8.20	KTL75TD1D		KVL75TD1D	
90	40	6.80	KTL90TD1A		KVL90TD1A	
	60	8.60	KTL90TD1C		KVL90TD1C	
	65	8.70	KTL90TD1D		KVL90TD1D	
	80	9.40	KTL90TD1E		KVL90TD1E	
110	40	7.60	KTM11TD1A		KVM11TD1A	
	60	9.40	KTM11TD1C		KVM11TD1C	
	65	9.50	KTM11TD1D		KVM11TD1D	
	80	11.00	KTM11TD1E		KVM11TD1E	
125	100	12.20	KTM11TD1F		KVM11TD1F	
	40	9.20	KTM12TD1A		KVM12TD1A	
	60	10.80	KTM12TD1C		KVM12TD1C	
	65	11.10	KTM12TD1D		KVM12TD1D	
	80	11.50	KTM12TD1E		KVM12TD1E	
	100	12.20	KTM12TD1F		KVM12TD1F	
	125	15.00	KTM12TD1G		KVM12TD1G	
140	40	9.34	KZM14TD1A			
	60 (1)	11.04	KZM14TD1C			
	80	12.35	KZM14TD1E			
	100	14.03	KZM14TD1F			
	125	16.28	KZM14TD1G			
160	40	10.60	KZM16TD1A			
	60 (1)	12.35	KZM16TD1C			
	80	13.73	KZM16TD1E			
	100	15.40	KZM16TD1F			
	125	17.74	KZM16TD1G			
200	150	20.16	KZM16TD1J			
	40	14.32	KZM20TD1A			
	60 (1)	16.27	KZM20TD1C			
	80	17.74	KZM20TD1E			
	100	19.67	KZM20TD1F			
	125	22.05	KZM20TD1G			
	150	24.54	KZM20TD1J			
225	200	29.09	KZM20TD1K			
	200 (2)	29.09	KZM20TD2K			
	60 (1)	18.23	KZM22TD1C			
	80	19.71	KZM22TD1E			
	100	21.75	KZM22TD1F			
225	150	26.67	KZM22TD1J			
	200	31.62	KZM22TD1K			
	200 (2)	31.62	KZM22TD2K			

(1) Flange DN 65 upon request.

(2) PN 16.

All socket tee IZIFIT®

DN/OD		weight (kg)	with non anchored gasket	with anchored gasket
DN	dn		reference	reference
75	75	5.60	KTL75TE0C	KVL75TE0C
90	75	6.40	KTL90TE0C	KVL90TE0C
	90	6.80	KTL90TE0D	KVL90TE0D
110	75	7.50	KTM11TE0C	KVM11TE0C
	90	7.80	KTM11TE0D	KVM11TE0D
	110	8.70	KTM11TE0E	KVM11TE0E
125	75	8.80	KTM12TE0C	KVM12TE0C
	90	9.20	KTM12TE0D	KVM12TE0D
	110	10.00	KTM12TE0E	KVM12TE0E
	125	11.00	KTM12TE0G	KVM12TE0G
140	110	10.55	KZM14TE0E	
	125	11.46	KZM14TE0G	
	140	11.90	KZM14TE0H	
160	110	11.93	KZM16TE0E	
	125	12.66	KZM16TE0G	
	140	13.25	KZM16TE0H	

Flanged spigot PN 10 / 16 IZIFIT®

DN/OD	DN flange	weight (kg)	reference
63	60(1)	3.62	KZL63BU1C
75	60	4.15	KTL75BU1C
	65	4.15	KTL75BU1D
90	80	4.70	KTL90BU1E
110	100	6.00	KTM11BU1F
125	125	7.90	KTM12BU1G
140	125	8.56	KZM14BU1G
160	150	10.64	KZM16BU1J
200	200	14.78	KZM20BU1K
	200(2)	14.78	KZM20BU2K
225	225	15.51	KZM22BU1K
	225(2)	15.51	KZM22BU2K

(1) Flange DN 65 upon request.

(2) PN16.

Flanged socket PN 10 / 16 IZIFIT®

DN/OD	DN flange	weight (kg)	with non anchored gasket	with anchored gasket
			reference	reference
63	60 (1)	3.88	KZL63BE1C	
75	60	5.3	KTL75BE1C	KVL75BE1C
	65	5.3	KTL75BE1D	KVL75BE1D
90	80	5.5	KTL90BE1E	KVL90BE1E
110	100	6.7	KTM11BE1F	KVM11BE1F
125	125	8.2	KTM12BE1G	KVM12BE1G
140	125	9.15	KZM14BE1G	
160	150	11.22	KZM16BE1J	
200	200	15.18	KZM20BE1K	
	200(2)	15.18	KZM20BE2K	
225	200	16.38	KZM22BE1K	
	200(2)	16.38	KZM22BE2K	

(1) Flange DN 65 upon request.

(2) PN16.



Duckfoot bend PN 10 / 16 IZIFIT®

DN/OD	DN flange	weight (kg)	with non anchored gasket reference	with anchored gasket reference
75	80	8.30	KTL75DF0E	KVL75DF0E
90		8.00	KTL90DF0E	KVL90DF0E
110		11.40	KTM11DF0E	KVM11DF0E
125		13.60	KTM12DF0E	KVM12DF0E



Stopper IZIFIT®

DN/OD	weight (kg)	with non anchored gasket reference	with anchored gasket reference
75	1.60	KTL75BH	KVL75BH
90	2.00	KTL90BH	KVL90BH
110	2.20	KTM11BH	KVM11BH
125	3.00	KTM12BH	KVM12BH
140	3.51	KZM14BH	
160	4.24	KZM16BH	

Lubricant

packaging	reference
Box (0.850 kg)	214611



Anchored gland

DN/OD	weight (kg)	reference
63	1.56	JZL63VXNN2
140	2.80	JZM14VXNN2
160	3.10	JZM16VXNN2
200	4.18	JZM20VXNN2
225	4.64	JZM22VXNN2



Unanchored BLUTOP® joint for ductile iron BLUTOP®, PVC-U

DN/OD	weight (kg)	reference
75	0.059	JXL75BAM
90	0.067	JXL90BAM
110	0.081	JXM11BAM
125	0.108	JXM12BAM
140	0.140	JXM14BAM
160	0.169	JXM16BAM



Anchored BLUTOP® joint only for ductile iron BLUTOP®

DN/OD	weight (kg)	reference
75	0.067	JXL75CAM
90	0.076	JXL90CAM
110	0.093	JXM11CAM
125	0.118	JXM12CAM
140	0.190	JXM14CA
160	0.221	JXM16CA



Anchored IZIFIT® joint for PVC-U, PE and PVC-BO

DN/OD	weight (kg)	reference
75	0.059	JIL75CA
90	0.067	JIL90CA
110	0.081	JIM11CA
125	0.108	JIM12CA

1/4 Bend BLUTOP®



DN/OD	weight (kg)	reference	with BLUTOP® joint	with anchored BLUTOP® joint	with anchored IZIFIT® joint
			reference	reference	reference
75	4.4	KXL75CA	KXL75CA-E00	KXL75CA-E06	KXL75CA-E02
90	5.5	KXL90CA	KXL90CA-E00	KXL90CA-E06	KXL90CA-E02
110	7.1	KXM11CA	KXM11CA-E00	KXM11CA-E06	KXM11CA-E02
125	8.8	KXM12CA	KXM12CA-E00	KXM12CA-E06	KXM12CA-E02
140	10.30	KXM14CA	KXM14CA-E00	KXM14CA-E06	
160	12.3	KXM16CA	KXM16CA-E00	KXM16CA-E06	

1/8 Bend BLUTOP®



DN/OD	weight (kg)	reference	with BLUTOP® joint	with anchored BLUTOP® joint	with anchored IZIFIT® joint
			reference	reference	reference
75	4.2	KXL75CB	KXL75CB-E00	KXL75CB-E06	KXL75CB-E02
90	5.1	KXL90CB	KXL90CB-E00	KXL90CB-E06	KXL90CB-E02
110	6.2	KXM11CB	KXM11CB-E00	KXM11CB-E06	KXM11CB-E02
125	7.0	KXM12CB	KXM12CB-E00	KXM12CB-E06	KXM12CB-E02
140	8.4	KXM14CB	KXM14CB-E00	KXM14CB-E06	
160	10.3	KXM16CB	KXM16CB-E00	KXM16CB-E06	

1/16 Bend BLUTOP®



DN/OD	weight (kg)	reference	with BLUTOP® joint	with anchored BLUTOP® joint	with anchored IZIFIT® joint
			reference	reference	reference
75	3.4	KXL75CD	KXL75CD-E00	KXL75CD-E06	KXL75CD-E02
90	4.4	KXL90CD	KXL90CD-E00	KXL90CD-E06	KXL90CD-E02
110	5.5	KXM11CD	KXM11CD-E00	KXM11CD-E06	KXM11CD-E02
125	6.6	KXM12CD	KXM12CD-E00	KXM12CD-E06	KXM12CD-E02
140	7.7	KXM14CD	KXM14CD-E00	KXM14CD-E06	
160	9.2	KXM16CD	KXM16CD-E00	KXM16CD-E06	

1/32 Bend BLUTOP®



DN/OD	weight (kg)	reference	with BLUTOP® joint	with anchored BLUTOP® joint	with anchored IZIFIT® joint
			reference	reference	reference
75	3.5	KXL75CE	KXL75CE-E00	KXL75CE-E06	KXL75CE-E02
90	3.8	KXL90CE	KXL90CE-E00	KXL90CE-E06	KXL90CE-E02
110	5.8	KXM11CE	KXM11CE-E00	KXM11CE-E06	KXM11CE-E02
125	6.7	KXM12CE	KXM12CE-E00	KXM12CE-E06	KXM12CE-E02
140	7.7	KXM14CE	KXM14CE-E00	KXM14CE-E06	
160	9.1	KXM16CE	KXM16CE-E00	KXM16CE-E06	

Semi-sliding collar BLUTOP®



DN/OD	weight (kg)	reference	with BLUTOP® joint reference
75	5.3	KXL75MM	KXL75MM-E00
90	6.3	KXL90MM	KXL90MM-E00
110	7.3	KXM11MM	KXM11MM-E00
125	8.8	KXM12MM	KXM12MM-E00
140	9.6	KXM14MM	KXM14MM-E00
160	10.7	KXM16MM	KXM16MM-E00

Non-sliding collar BLUTOP®



DN/OD	weight (kg)	reference	with BLUTOP® joint reference	with anchored BLUTOP® joint reference	with anchored IZIFIT® joint reference
90	4.0	KXL90MN	KXL90MN-E00	KXL90MN-E06	KXL90MN-E02
110	4.9	KXM11MN	KXM11MN-E00	KXM11MN-E06	KXM11MN-E02
125	5.5	KXM12MN	KXM12MN-E00	KXM12MN-E06	KXM12MN-E02

BLUTOP® taper



DN/OD	Ø de mm	weight (kg)	reference	with BLUTOP® joint reference	with anchored BLUTOP® joint reference	with anchored IZIFIT® joint reference
90	75	3.6	KXL90VE0C	KXL90VE0C-E00	KXL90VE0C-E06	KXL90VE0C-E02
110	75	4.6	KXM11VE0C	KXM11VE0C-E00	KXM11VE0C-E06	KXM11VE0C-E02
	90	5.0	KXM11VE0D	KXM11VE0D-E00	KXM11VE0D-E06	KXM11VE0D-E02
125	75	5.1	KXM12VE0C	KXM12VE0C-E00	KXM12VE0C-E06	KXM12VE0C-E02
	90	5.2	KXM12VE0D	KXM12VE0D-E00	KXM12VE0D-E06	KXM12VE0D-E02
	110	5.5	KXM12VE0E	KXM12VE0E-E00	KXM12VE0E-E06	KXM12VE0E-E02
140	90	5.4	KXM14VE0D	KXM14VE0D-E00	KXM14VE0D-E06	
	110	5.8	KXM14VE0E	KXM14VE0E-E00	KXM14VE0E-E06	
	125	6.1	KXM14VE0G	KXM14VE0G-E00	KXM14VE0G-E06	
	75	6.5	KXM16VE0C	KXM16VE0C-E00	KXM16VE0C-E06	
160	90	7.0	KXM16VE0D	KXM16VE0D-E00	KXM16VE0D-E06	
	110	7.4	KXM16VE0E	KXM16VE0E-E00	KXM16VE0E-E06	
	125	7.8	KXM16VE0G	KXM16VE0G-E00	KXM16VE0G-E06	
	140	7.4	KXM16VE0H	KXM16VE0H-E00	KXM16VE0H-E06	

Double socket tee with flange branch BLUTOP® PN 10 - 16



DN/OD	DN	dn	weight (kg)	without joint	with BLUTOP® joint	with anchored BLUTOP® joint	with anchored IZIFIT® joint
				reference	reference	reference	reference
75	40	5.8	KXL75TD1A	KXL75TD1A-E00	KXL75TD1A-E06	KXL75TD1A-E02	
	60	7.8	KXL75TD1C	KXL75TD1C-E00	KXL75TD1C-E06	KXL75TD1C-E02	
	65	8.2	KXL75TD1D	KXL75TD1D-E00	KXL75TD1D-E06	KXL75TD1D-E02	
90	40	6.8	KXL90TD1A	KXL90TD1A-E00	KXL90TD1A-E06	KXL90TD1A-E02	
	60	8.6	KXL90TD1C	KXL90TD1C-E00	KXL90TD1C-E06	KXL90TD1C-E02	
	65	8.7	KXL90TD1D	KXL90TD1D-E00	KXL90TD1D-E06	KXL90TD1D-E02	
	80	9.4	KXL90TD1E	KXL90TD1E-E00	KXL90TD1E-E06	KXL90TD1E-E02	
110	40	7.6	KXM11TD1A	KXM11TD1A-E00	KXM11TD1A-E06	KXM11TD1A-E02	
	60	9.4	KXM11TD1C	KXM11TD1C-E00	KXM11TD1C-E06	KXM11TD1C-E02	
	65	9.5	KXM11TD1D	KXM11TD1D-E00	KXM11TD1D-E06	KXM11TD1D-E02	
	80	11.0	KXM11TD1E	KXM11TD1E-E00	KXM11TD1E-E06	KXM11TD1E-E02	
100	12.2	KXM11TD1F	KXM11TD1F-E00	KXM11TD1F-E06	KXM11TD1F-E02		
125	40	9.2	KXM12TD1A	KXM12TD1A-E00	KXM12TD1A-E06	KXM12TD1A-E02	
	60	10.8	KXM12TD1C	KXM12TD1C-E00	KXM12TD1C-E06	KXM12TD1C-E02	
	65	11.1	KXM12TD1D	KXM12TD1D-E00	KXM12TD1D-E06	KXM12TD1D-E02	
	80	11.5	KXM12TD1E	KXM12TD1E-E00	KXM12TD1E-E06	KXM12TD1E-E02	
	100	12.2	KXM12TD1F	KXM12TD1F-E00	KXM12TD1F-E06	KXM12TD1F-E02	
125	15.0	KXM12TD1G	KXM12TD1G-E00	KXM12TD1G-E06	KXM12TD1G-E02		
140	40	9.3	KXM14TD1A	KXM14TD1A-E00	KXM14TD1A-E06		
	60	11.1	KXM14TD1C	KXM14TD1C-E00	KXM14TD1C-E06		
	65	11.25	KXM14TD1D	KXM14TD1D-E00	KXM14TD1D-E06		
	80	12.4	KXM14TD1E	KXM14TD1E-E00	KXM14TD1E-E06		
	100	14.1	KXM14TD1F	KXM14TD1F-E00	KXM14TD1F-E06		
125	16.4	KXM14TD1G	KXM14TD1G-E00	KXM14TD1G-E06			

DN/OD		weight (kg)	without joint	with BLUTOP® joint	with anchored BLUTOP® joint	with anchored IZIFIT® joint
DN	dn		reference	reference	reference	reference
160	40	11.3	KXM16TD1A	KXM16TD1A-E00	KXM16TD1A-E06	
	60	12.9	KXM16TD1C	KXM16TD1C-E00	KXM16TD1C-E06	
	65	12.9	KXM16TD1D	KXM16TD1D-E00	KXM16TD1D-E06	
	80	14.3	KXM16TD1E	KXM16TD1E-E00	KXM16TD1E-E06	
	100	16.4	KXM16TD1F	KXM16TD1F-E00	KXM16TD1F-E06	
	125	18.0	KXM16TD1G	KXM16TD1G-E00	KXM16TD1G-E06	
	150	20.3	KXM16TD1J	KXM16TD1J-E00	KXM16TD1J-E06	

Double socket tee with flange branch BLUTOP® PN 25

DN/OD		weight (kg)	without joint	with BLUTOP® joint	with anchored BLUTOP® joint	with anchored IZIFIT® joint	
DN	dn		reference	reference	reference	reference	
75	40	5.8	KXL75TD1A	KXL75TD1A-E00	KXL75TD1A-E06	KXL75TD1A-E02	
	60	7.1	KXL75TD3C	KXL75TD3C-E00	KXL75TD3C-E06	KXL75TD3C-E02	
	65	7.5	KXL75TD3D	KXL75TD3D-E00	KXL75TD3D-E06	KXL75TD3D-E02	
90	40	6.8	KXL90TD1A	KXL90TD1A-E00	KXL90TD1A-E06	KXL90TD1A-E02	
	60	8.4	KXL90TD3C	KXL90TD3C-E00	KXL90TD3C-E06	KXL90TD3C-E02	
	65	8.7	KXL90TD3D	KXL90TD3D-E00	KXL90TD3D-E06	KXL90TD3D-E02	
90	80	9.4	KXL90TD1E	KXL90TD1E-E00	KXL90TD1E-E06	KXL90TD1E-E02	
	110	40	7.6	KXM11TD1A	KXM11TD1A-E00	KXM11TD1A-E06	KXM11TD1A-E02
		60	9.5	KXM11TD3C	KXM11TD3C-E00	KXM11TD3C-E06	KXM11TD3C-E02
65		9.8	KXM11TD3D	KXM11TD3D-E00	KXM11TD3D-E06	KXM11TD3D-E02	
110	80	11.0	KXM11TD1E	KXM11TD1E-E00	KXM11TD1E-E06	KXM11TD1E-E02	
	100	12.4	KXM11TD3F	KXM11TD3F-E00	KXM11TD3F-E06	KXM11TD3F-E02	
	125	40	9.2	KXM12TD1A	KXM12TD1A-E00	KXM12TD1A-E06	KXM12TD1A-E02
60		10.8	KXM12TD3C	KXM12TD3C-E00	KXM12TD3C-E06	KXM12TD3C-E02	
65		11.3	KXM12TD3D	KXM12TD3D-E00	KXM12TD3D-E06	KXM12TD3D-E02	
80		11.5	KXM12TD1E	KXM12TD1E-E00	KXM12TD1E-E06	KXM12TD1E-E02	
100		13.7	KXM12TD3F	KXM12TD3F-E00	KXM12TD3F-E06	KXM12TD3F-E02	
125	125	16.8	KXM12TD3G	KXM12TD3G-E00	KXM12TD3G-E06	KXM12TD3G-E02	
	140	40	9.12	KXM14TD1A	KXM14TD1A-E00	KXM14TD1A-E06	
		60	11.08	KXM14TD3C	KXM14TD3C-E00	KXM14TD3C-E06	
		65	11.67	KXM14TD3D	KXM14TD3D-E00	KXM14TD3D-E06	
		80	11.85	KXM14TD1E	KXM14TD1E-E00	KXM14TD1E-E06	
100		14.50	KXM14TD3F	KXM14TD3F-E00	KXM14TD3F-E06		
140	125	16.20	KXM14TD3G	KXM14TD3G-E00	KXM14TD3G-E06		
	160	40	11.3	KXM16TD1A	KXM16TD1A-E00	KXM16TD1A-E06	
		60	12.9	KXM16TD3C	KXM16TD3C-E00	KXM16TD3C-E06	
		65	13.3	KXM16TD3D	KXM16TD3D-E00	KXM16TD3D-E06	
		80	14.3	KXM16TD1E	KXM16TD1E-E00	KXM16TD1E-E06	
100		17.0	KXM16TD3F	KXM16TD3F-E00	KXM16TD3F-E06		
160	125	19.0	KXM16TD3G	KXM16TD3G-E00	KXM16TD3G-E06		
	150	21.6	KXM16TD3J	KXM16TD3J-E00	KXM16TD3J-E06		



Three sockets tee BLUTOP®

DN/OD		weight (kg)	without joint	with BLUTOP® joint	with anchored BLUTOP® joint	with anchored IZIFIT® joint	
DN	dn		reference	reference	reference	reference	
75	75	5.6	KXL75TE0C	KXL75TE0C-E00	KXL75TE0C-E06	KXL75TE0C-E02	
	90	6.3	KXL90TE0C	KXL90TE0C-E00	KXL90TE0C-E06	KXL90TE0C-E02	
90	90	6.8	KXL90TE0D	KXL90TE0D-E00	KXL90TE0D-E06	KXL90TE0D-E02	
	75	8.0	KXM11TE0C	KXM11TE0C-E00	KXM11TE0C-E06	KXM11TE0C-E02	
110	90	7.8	KXM11TE0D	KXM11TE0D-E00	KXM11TE0D-E06	KXM11TE0D-E02	
	110	8.7	KXM11TE0E	KXM11TE0E-E00	KXM11TE0E-E06	KXM11TE0E-E02	
125	75	8.8	KXM12TE0C	KXM12TE0C-E00	KXM12TE0C-E06	KXM12TE0C-E02	
	90	9.2	KXM12TE0D	KXM12TE0D-E00	KXM12TE0D-E06	KXM12TE0D-E02	
	110	10.0	KXM12TE0E	KXM12TE0E-E00	KXM12TE0E-E06	KXM12TE0E-E02	
125	125	11.0	KXM12TE0G	KXM12TE0G-E00	KXM12TE0G-E06	KXM12TE0G-E02	
	140	110	10.5	KXM14TE0E	KXM14TE0E-E00	KXM14TE0E-E06	
		125	11.3	KXM14TE0G	KXM14TE0G-E00	KXM14TE0G-E06	
140	140	11.8	KXM14TE0H	KXM14TE0H-E00	KXM14TE0H-E06		
	160	110	13.0	KXM16TE0E	KXM16TE0E-E00	KXM16TE0E-E06	
		125	13.6	KXM16TE0G	KXM16TE0G-E00	KXM16TE0G-E06	
160	140	13.3	KXM16TE0H	KXM16TE0H-E00	KXM16TE0H-E06		
	160	15.1	KXM16TE0J	KXM16TE0J-E00	KXM16TE0J-E06		

Flange spigot BLUTOP® PN 10 - 16

DN/OD	DN flange	weight (kg)	reference
75	60	3.85	KXL75BU1C
	65	4.15	KXL75BU1D
90	80	4.8	KXL90BU1E
110	100	6.0	KXM11BU1F
125	125	7.9	KXM12BU1G
140	125	9.56	KXM14BU1G
160	150	12.1	KXM16BU1J



Flange spigot BLUTOP® PN 25

DN/OD	DN flange	weight (kg)	reference
75	60	3.8	KXL75BU3C
	65	4.1	KXL75BU3D
90	80	4.8	KXL90BU1E
110	100	6.7	KXM11BU3F
125	125	8.9	KXM12BU3G
140	125	9.56	KXM14BU3G
160	150	12.1	KXM16BU3J

Flange socket BLUTOP® PN 10 - 16

DN/OD	DN flange	weight (kg)	without joint reference	with BLUTOP® joint reference	with anchored BLUTOP® joint reference	with anchored IZIFIT® joint reference
75	60	5.0	KXL75BE1C	KXL75BE1C-E00	KXL75BE1C-E06	KXL75BE1C-E02
	65	5.3	KXL75BE1D	KXL75BE1D-E00	KXL75BE1D-E06	KXL75BE1D-E02
90	80	5.5	KXL90BE1E	KXL90BE1E-E00	KXL90BE1E-E06	KXL90BE1E-E02
110	100	6.7	KXM11BE1F	KXM11BE1F-E00	KXM11BE1F-E06	KXM11BE1F-E02
125	125	8.2	KXM12BE1G	KXM12BE1G-E00	KXM12BE1G-E06	KXM12BE1G-E02
140	125	9.56	KXM14BE1G	KXM14BE1G-E00	KXM14BE1G-E06	
160	150	11.0	KXM16BE1J	KXM16BE1J-E00	KXM16BE1J-E06	



Flange socket BLUTOP® PN 25

DN/OD	DN flange	weight (kg)	without joint reference	with BLUTOP® joint reference	with anchored BLUTOP® joint reference	with anchored IZIFIT® joint reference
75	60	4.2	KXL75BE3C	KXL75BE3C-E00	KXL75BE3C-E06	KXL75BE3C-E02
	65	4.7	KXL75BE3D	KXL75BE3D-E00	KXL75BE3D-E06	KXL75BE3D-E02
90	80	5.5	KXL90BE1E	KXL90BE1E-E00	KXL90BE1E-E06	KXL90BE1E-E02
110	100	7.4	KXM11BE3F	KXM11BE3F-E00	KXM11BE3F-E06	KXM11BE3F-E02
125	125	8.9	KXM12BE3G	KXM12BE3G-E00	KXM12BE3G-E06	KXM12BE3G-E02
140	125	9.56	KXM14BE3G	KXM14BE3G-E00	KXM14BE3G-E06	
160	150	12.1	KXM16BE3J	KXM16BE3J-E00	KXM16BE3J-E06	



Duckfoot bend BLUTOP® PN 10 - 16

DN/OD	DN flange	weight (kg)	without joint reference	with BLUTOP® joint reference	with anchored BLUTOP® joint reference	with anchored IZIFIT® joint reference
75	80	8.3	KXL75DF0E	KXL75DF0E-E00	KXL75DF0E-E06	KXL75DF0E-E02
90	80	8.0	KXL90DF0E	KXL90DF0E-E00	KXL90DF0E-E06	KXL90DF0E-E02
110	80	11.4	KXM11DF0E	KXM11DF0E-E00	KXM11DF0E-E06	KXM11DF0E-E02
100	12,3	12,3	KXM11DF0F	KXM11DF0F-E00	KXM11DF0F-E06	KXM11DF0F-E02
125	80	13.6	KXM12DF0E	KXM12DF0E-E00	KXM12DF0E-E06	KXM12DF0E-E02
140	80	14.0	KXM14DF0E	KXM14DF0E-E00	KXM14DF0E-E06	
160	80	16.2	KXM16DF0E	KXM16DF0E-E00	KXM16DF0E-E06	
	100	16.4	KXM16DF0F	KXM16DF0F-E00	KXM16DF0F-E06	

BLUTOP® plug

DN/OD	weight (kg)	without joint reference	with BLUTOP® joint reference	with anchored BLUTOP® joint reference	with anchored IZIFIT® joint reference
75	1.6	KXL75BH	KXL75BH-E00	KXL75BH-E06	KXL75BH-E02
90	2.0	KXL90BH	KXL90BH-E00	KXL90BH-E06	KXL90BH-E02
110	2.2	KXM11BH	KXM11BH-E00	KXM11BH-E06	KXM11BH-E02
125	2.95	KXM12BH	KXM12BH-E00	KXM12BH-E06	KXM12BH-E02
140	3.5	KXM14BH	KXM14BH-E00	KXM14BH-E06	
160	4.3	KXM16BH	KXM16BH-E00	KXM16BH-E06	



BIM

BIM (Building Information Modeling) is a new method for managing construction and infrastructure projects based on 3D digital models containing reliable and structured data.

Saint-Gobain PAM Canalisation offers to simplify and optimize the infrastructure design phases by offering its library of BIM objects.

This new version offers free digital twins of products marketed by **SAINT-GOBAIN PAM CANALISATION**. Compliant with the NF ISO 23387 standard, BIM objects contain all the characteristics specific to the products (length, diameter, type of coating, type of junction, etc.). It is also possible to very easily and quickly integrate these objects into more complex environments (valve chamber, structures) while guaranteeing the conformity of the design phases

This BIM library is designed to facilitate design processes and improve communication between project managers. The proposed objects are realistic, easy to use, compliant with current standards and highly configurable. They thus meet the requirements and needs of solution designers. This library accelerates all the design and validation processes, thus contributing to cost reduction.



REGISTER ON THE SITE TO ACCESS THE LIBRARY AND BE INFORMED OF UPDATES



ALL BIM OBJECTS ARE HIGHLY CONFIGURABLE



IT IS DESIGN SUPPORT FOR valves chambers

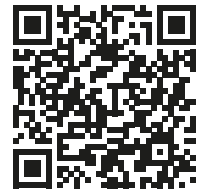

Scan the QRcode to access the BIM library

Contact : your PAM Manager or
BIM.PAM-International@saint-gobain.com



PAMLINE



PAMLINE TV



LINKEDIN



HOW TO CONTACT PAM around the world

ARGENTINA
SAINT-GOBAIN PAM ARGENTINA
Bouchard y Enz
1836 - LLAVALLOL - BUENOS AIRES - Argentina
Tel.: + 54 11 42 98 9600

AUSTRIA
SAINT-GOBAIN AUSTRIA GMBH
Vertriebsbüro PAM
Archenweg 52
6020 Innsbruck
Tel.: + 43-512-341717-0

BELGIUM
SAINT-GOBAIN PAM BELGIUM S.A.
Raathovenstraat, n°2
B-3400 - LANDEN - Belgium
Tel.: + 32 11 88 01 20

BRAZIL
SAINT-GOBAIN CANALIZACAO LTDA
7ª Andar Condomínio do Edifício Praia de Botafogo
22250-040 - RIO DE JANEIRO - RJ - Brazil
Tel.: + 55 21 2128 1677

CHILE
SAINT-GOBAIN CANALIZACIÓN CHILE S.A.
Antillanca Norte 600
Parque Industrial Vespucio, Comuna de Pudahuel
SANTIAGO DE CHILE - Chili
Tel.: + (56-02) 24441300

CHINA
SAINT-GOBAIN PAM CHINA
Room 1808, 18th Floor, Building No.5
Zi Yun Wisdom Plaza, No. 19,
Ka Zi Men Avenue, Qinghuai District, 210022 -
Nanjing, China
Tel.: + 86 25 5791 8553

COLOMBIA
COLOMBIA, CENTRAL AMERICA, ECUADOR &
DOMINICAN REPUBLIC
SAINT-GOBAIN PAM COLOMBIA
Km 20 Carretera Occidente, MOSQUERA,
CUNDINAMARCA - Colombia
Tel.: + 57 (1) 893 3993

CZECH REPUBLIC
SAINT-GOBAIN PAM CZ S.R.O.
Smrčkova 2485/4
180 00 Praha 8 - Czech Republic
Tel.: + 420 220 406 640

FINLAND
SAINT-GOBAIN PAM FINLAND
Strömberginkuja 2
FI-00380 HELSINKI
Tel.: +358,207,424,622

**FRANCE & FRENCH OVERSEAS DEPARTMENTS
AND TERRITORIES**
SAINT-GOBAIN PAM CANALISATION
(REGISTERED OFFICE)
21 avenue Camille Cavallier
54705 PONT-A-MOUSSON CEDEX - France
Tel.: +33 3 83 80 73 50

**SAINT-GOBAIN PAM CANALISATION
(SALES DIVISION FRANCE)**
21 avenue Camille Cavallier
54705 - PONT A MOUSSON CEDEX - France
Tel.: +33 3 83 80 67 89

**SAINT-GOBAIN PAM CANALISATION
(Sales Divisions Europe and international)**
21 avenue Camille Cavallier
54705 - PONT A MOUSSON CEDEX - France
Tel.: +33 3 83 80 67 89

**SAINT-GOBAIN PAM CANALISATION
(Caribbean Regional Agency)**
Rue Alfred Lumière - ZI de Jarry - BP 2104
97122 - BAIE MAHAULT - Guadeloupe
Tel.: + 33 590 26 71 46

GERMANY
SAINT-GOBAIN PAM DEUTSCHLAND
Saarbrucker Strasse 51
66130 - SAARBRÜCKEN - Germany
Tel.: + 49 681 87 010

GREECE
SAINT-GOBAIN HELLAS ABEE
5 Kleisouras Str.
Metamorfosi Athens 14452, Greece
Tel.: + 30 210 6147500

ITALY
SAINT-GOBAIN PAM ITALIA SPA
Via Romagnoli n°6
I-20146 - MILAN - Italy
Tel.: + 39 02 42 431

JORDAN
SAINT-GOBAIN PAM CANALISATION REGIONAL
OFFICE
Abu Zaid Center - Office # 8
37 Saad Bin Abi Waqqas St, - PO BOX 831000
11183 AMMAN - Jordan
Tel.: + 962 6 551 4438

MEXICO
SAINT-GOBAIN PAM MEXICO
Legaria 549 Torre 1 Piso 14 • 10 de Abril •
11250, Ciudad de México - Mexico
Tel.: +(52) 55 5279 1665

MOROCCO
SAINT-GOBAIN MAROC DEVELOPMENT
Av Mly Ismail Route de Rabat Ain Sebaa
20250 - Casablanca
Tel.: + 212 522 665 731

NETHERLANDS
SAINT-GOBAIN PAM NL
Markerkant 10-17
1316 AB ALMERE - The Netherlands
Tel.: + 31 365333344

NORWAY
SAINT-GOBAIN BYGGEVARER AS, PAM
Brobekkveien 84
0582 Oslo
Tel.: + 47 23 17 58 60

PERU
SAINT-GOBAIN PAM PERU
Av. Javier Prado Oeste Nro. 2501 Int. 2101
(Edificio Bloom Tower) - Magdalena - Lima
Tel.: +(51) 1 2524034

POLAND
SAINT-GOBAIN CONSTRUCTION PRODUCTS
POLSKA SP. Z O.O.
ul. Okrezna 16, 44-100 Gliwice
Tel.: +48 600 421 996

PORTUGAL
SAINT-GOBAIN PAM PORTUGAL, S.A.
Rua das Marinhas do Tejo, n° 15
2690-361 - SANTA IRIA DE AZOIA - Portugal
Tel.: + 351 218 925 000

ROMANIA
SAINT-GOBAIN CONSTRUCTION PRODUCTS
ROMANIA S.R.L.
Calea Floreasca nr. 165, One United Tower,
etaj 10, Sector 1, cod 014459
Bucuresti România
Tel.: + 40 21 207 57 50

SINGAPORE
SAINT-GOBAIN PAM SINGAPORE
2 Venture Dr., #13-18 Vision Exchange,
Singapore 608526
Tel.: +65 6330 8288

SLOVAKIA
SAINT-GOBAIN CONSTRUCTION PRODUCTS
PAM Business Unit
Dlha 1780/6
90031 Stupava
Tel.: + 421 265 45 69 61

SOUTH AFRICA
SAINT-GOBAIN PIPELINES SOUTH AFRICA
300 Janadel Ave
Halfway House, Midrand
South Africa
Tel.: +27 (12) 657 2800

SPAIN
SAINT-GOBAIN PAM ESPANA
C/ Príncipe de Vergara, 132 planta 7
28002 - Madrid
Tel.: +34 91 397 20 00

UNITED KINGDOM
SAINT-GOBAIN PAM UK
Lows Lane - Stanton-by-Dale
ILKESTON - DERBYSHIRE - DE7 4QU
United Kingdom
Tel.: + 44 115 930 5000

VIETNAM
SG PAM HCM
8th Floor, SOFIC Tower,
10 Mai Chi Tho Street, Thu Thiem Ward, District
2
Ho Chi Minh City
Viet Nam
Tel.: +84 28 3776 1888



**Saint-Gobain PAM Canalisation •
Head office**

21, avenue Camille Cavallier
54705 Pont-à-Mousson Cedex • FRANCE
Phone : +33 (0) 383 807 350
www.pamline.com