

TCSL DN65 – Diaphragm 45m³/h

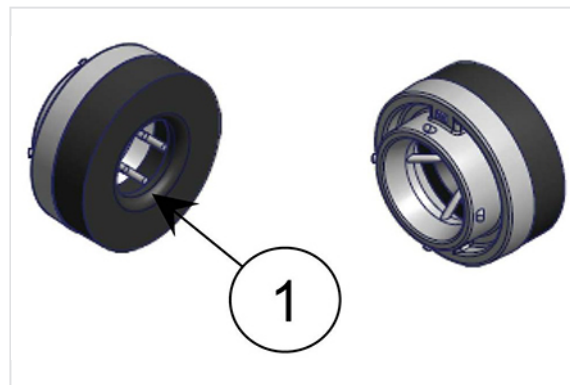

Net weight	References
0.30 kg	166753

Note: the marking on the diaphragm must be positioned up

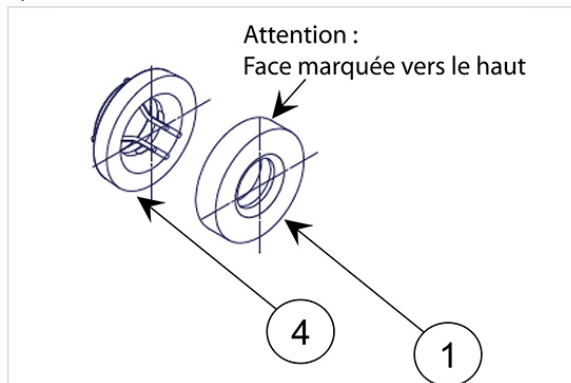

Each kit contains 5 diaphragms

Item	Description	Number	Material
1	Diaphragm 45m ³ /h	1	SBR

Remark: the cartridge Rep N°4 is not included in the kit

Instruction for diaphragm replacement

- Remove the diaphragm (Rep N°1) of the cartridge (Rep N°4)
- Clean the support surface if necessary
- Install the new diaphragm, make sure that the marking on the top of the diaphragm is positioned up

The information on this sketch is, to the best of our knowledge correct at the time of printing. However Saint-Gobain are constantly looking at ways of improving their products and services therefore reserve the right to change without prior notice, any of the data shown. Any orders placed will be subject to our Standard Conditions of Sale, available on request.